

The 2023 ATP® Official Rulebook



Copyright © 2023 by ATP Tour, Inc.
All Rights Reserved.

Reproduction of this work in whole or in part without the written permission of the ATP Tour, Inc., is prohibited.

Printed in the United States of America.

TABLE OF CONTENTS

I. ATP CIRCUIT REGULATIONS 7

1.01 Categories of Tournaments	7
1.02 Tournament Week	7
1.03 Match Schedule Plan	8
1.04 Finals Options	8
1.05 Change of Tournament Site.....	9
1.06 Commitment to Rules/ATP Official Rulebook.....	9
1.07 Commitment, Membership Obligations and Bonus Pool.....	9
1.08 Unsatisfied Player Commitment Penalties	13
1.09 Mandatory Player Meeting	13
1.10 Player Eligibility/Player University/Physical Exam.....	14
1.11 Waiver of Claims.....	14
1.12 Waiver/Player Publicity and Promotion	14
1.13 Stars Program	15
1.14 Special Events - Exhibitions.....	16
1.15 Promotional Fees	17
1.16 Virtual Insertion.....	17
1.17 Non-Exclusive Media Highlight Rights.	17
1.18 Quality/Broadcast	18
1.19 Seating and Attendance	18
1.20 Hotel Accommodations (Rooms)	18

II. BRANDING 25

2.01 Identification - ATP Tour Tournaments.....	25
2.02 Identification - ATP Challenger Tour Tournaments.....	31

III. FINANCIAL 35

3.01 Composition of Commitment	35
3.02 Currency	35
3.03 Default of Prize Money Payments	35
3.04 Fee Obligation	35
3.05 Fees/Other Payments	36
3.06 Insurance.....	36
3.07 Letter of Credit - New/Conditional Tournaments.....	37
3.08 Prize Money	37
3.09 On-Site Prize Money	43
3.11 On-Site Prize Money Adjustment.....	44
3.12 Late Payment	45
3.13 Taxes-Notice of Withholdings	45
3.14 Withholding From Prize Money	45
3.15 Prizes and Non-Cash Awards.....	45
3.16 Release from Financial Commitment	46
3.17 ATP Masters 1000 Tournament Financial Information	46
3.18 ATP Masters 1000 Player Compensation & ATP Variable Bonus Pool....	50
3.19 ATP 500 and ATP 250 Tournament Financial Information	51
3.20 ATP 500 Prize Money Formula Rule	56
3.21 250 Tournament Prize Money.....	58

IV. WORLD CHAMPIONSHIPS 59

4.01 Nitto ATP Finals - Singles	59
---------------------------------------	----

TABLE OF CONTENTS

4.02 Nitto ATP Finals - Doubles	62
4.03 United Cup	65
4.04 Next Gen ATP Finals	81

V. PERSONNEL 87

5.01 Tournament Director	87
5.02 Tour Manager	87
5.03 Public Relations ("PR")	87
5.04 Doctor, Physiotherapist and Massage Therapist	88
5.05 Agents, Tier I and Tier II	89
5.06 Supervisor	90
5.07 Chair Umpire / Review Official	91
5.08 Line Umpire	95
5.09 Referee	96
5.10 Chief of Umpires	98
5.11 Ball Persons	99
5.12 ATP/GRAND SLAMS/ITF/WTA Code of Conduct for Officials	99

VI. FACILITIES & ON-SITE CONDITIONS 101

6.01 Courts	101
6.02 Match and Practice Courts	103
6.03 Balls	104
6.04 Crowd Movement / Spectator Seating	106
6.05 Security at Tournaments	107
6.06 Equipment & Supplies	107
6.07 Temperature and Ventilation For Indoor Facilities	109
6.08 Offices	109
6.09 Communication Devices	109
6.10 Tournament Credentialing and Ticketing	110
6.11 Player Benefits - Guest Passes/Credentials/Tickets	112
6.12 ATP Family Lounge and ATP Player Lounge	113
6.13 Locker Room	114
6.14 The Gymnasium ("Gym")	114
6.15 Laundry Service	115
6.16 Stringing Service	115
6.17 Food	116
6.19 On-Site Access / Limits to On-Site Access	117
6.19 Transportation	117
6.20 Physiotherapist/Treatment Room	117
6.21 Automated External Defibrillator ("AED")	118
6.22 First Aid	118
6.23 Anti-Doping Facilities and On-Site Personnel Assistance	118
6.24 Media Facilities Guidelines	119
6.25 Electronic Line Calling Facilities Guidelines	120

VII. THE COMPETITION 121

7.01 ATP Fees	121
7.02 Entries	121
7.03 Entry Deadlines	122
7.04 Entry/Withdrawal Method	128
7.05 Withdrawal/Late Withdrawal Penalties	131

TABLE OF CONTENTS

7.06 One Tournament Per Week and Exception	134
7.07 Play-Up Regulation (ATP Challenger Tour Tournaments)	135
7.08 The Draw	136
7.09 Size and Method of Draw	140
7.10 Special Exempts (SE)	142
7.11 Time of Draw	147
7.12 Wild Cards	147
7.13 Selection of Entries	149
7.14 Seeds Definition	155
7.15 Number of Seeds	155
7.16 Placement of Seeds - Main Draw	156
7.17 Qualifying Placement	157
7.18 Byes - Assignment and Placement	157
7.19 Remake of Draw	158
7.20 Lucky Losers, Substitutions and Vacancies	159
7.21 Match Scheduling	168
7.22 On-Court Procedures and Requirements	175
7.23 Line Umpire Requirement, Positions and Calls	196
7.24 Scoring of Match	198
7.25 Announcing	199

VIII. THE CODE 203

8.01 Tournament Obligations	203
8.02 Tournament Standards Violations	203
8.03 Tournament Major Offenses	205
8.04 Player Code of Conduct ("Code")	208
8.05 Player Major Offenses/Procedures	233
8.06 Tennis Anti-Corruption Program ("TACP")	237
8.07 Final Dispute Resolution	237

IX. Pepperstone ATP RANKINGS 239

9.01 Definitions	239
9.02 Eligibility	239
9.03 Pepperstone ATP Rankings	240
9.04 Pepperstone ATP Doubles Rankings	244
9.05 2023 Pepperstone ATP Doubles Team Rankings	247
9.06 Retiring from the Professional Tennis Circuit	247

X. EXHIBITS 249

EXHIBIT A.01 - ATP Tour Official Tournament Stamps	249
EXHIBIT A.02 - Size Relationships - Men Only Events	249
EXHIBIT A.03 - Size Relationship - Combined Events	250
EXHIBIT A.04 - Positioning	251
EXHIBIT A.05 - Exclusion Area	252
EXHIBIT A.06.1 - Acceptable & Unacceptable uses - Men Only	253
EXHIBIT A.06.2 - Acceptable & Unacceptable Uses - Men Only	254
EXHIBIT A.06.3 - Acceptable & Unacceptable Uses - Men only	255
EXHIBIT A.06.4 Acceptable & Unacceptable Uses - Combined	256
EXHIBIT A.06.5 Acceptable & Unacceptable Uses - Combined	257
EXHIBIT A.06.6 - Acceptable & Unacceptable Uses - Combined	258
EXHIBIT A.07 - Website Exhibit	259

TABLE OF CONTENTS

EXHIBIT A.08 - Scoreboards / Draw Boards	259
EXHIBIT A.09 - Electronic Devices.....	260
EXHIBIT A.10 - Nets / Net Signage.....	261
EXHIBIT A.11 - Media Backdrop	262
EXHIBIT A.12 - Court Surface Color	263
EXHIBIT A.13.1 - Court Host Locality - Option 1 - Hard Court	264
EXHIBIT A.13.1 - Court Host Locality - Option 1 - Clay Court.....	265
EXHIBIT A.13.2 - Court Host Locality - Option 2 - Text	266
EXHIBIT A.13.2 - Court Host Locality - Option 2 - Logo.....	267
EXHIBIT A.13.3 - ATP Challenger Tour Court Surface ID.....	268
EXHIBIT A.14 - Court Backdrops	269
EXHIBIT A.15 - ATP Challenger Tour Brand Mark.....	270
EXHIBIT A.16 - ATP Challenger Tour Website	270
EXHIBIT A.17. ATP Challenger Tour Court Backdrops.....	271
EXHIBIT B - ATP Tour Logo.....	272
EXHIBIT C - Broadcast Standards	274
EXHIBIT D - Attendance Standards	278
EXHIBIT E - Virtual Insertion	280
EXHIBIT F - Lighting.....	281
EXHIBIT G - ATP Challenger Tour Logo (Print & Promotional Materials).....	282
EXHIBIT H - ATP Challenger Tour Logo (On-Court Version).....	282
EXHIBIT I - Rules of Tennis.....	283
EXHIBIT J - Prize Money	317
EXHIBIT K - Glossary.....	318
EXHIBIT L - Chief of Umpires.....	322
EXHIBIT M - Special Exempts - ATP 250 to ATP 500 Events	324
EXHIBIT O - Consent and Agreement Form	327
EXHIBIT P - Privacy Notice ("HIPPA").....	330
EXHIBIT Q - Player Food Service	334
EXHIBIT R - Player Medical Facility Guidelines	335
EXHIBIT S - Media Facilities Guidelines	341
EXHIBIT T - Electronic Line Calling Facilities Guidelines.....	342
EXHIBIT U - Review Officials Duties and Procedures for the ELC Systems.....	343
EXHIBIT U.1 - Review Electronic Line Calling System (Review ELC).....	344
EXHIBIT U.2 - Live Electronic Line Calling System (LIVE ELC)	351
EXHIBIT V - Anti-Doping Testing Facilities Guidelines	354
EXHIBIT W - Retractable Roof Policy	356
EXHIBIT X - Writing Table For Umpire Chairs.....	357
EXHIBIT Y - Premier Player Protocol	360
EXHIBIT Z - Player Gym	361
EXHIBIT AA - Mandatory Physical.....	363
EXHIBIT AB - Clothing Logos.....	364
EXHIBIT AC - Sample Basic Accreditation Policy Wording	367
EXHIBIT AD - ATP Fantasy Sport and Betting Sponsorship	373

INDEX.....	379
------------	-----

I. ATP CIRCUIT REGULATIONS

1.01 Categories of Tournaments

In official men's professional tennis, there are five (5) categories of events. ATP Tour tournaments and ATP Challenger Tour tournaments are governed by ATP. Unless otherwise specified, all regulations are applicable to both ATP Tour and ATP Challenger Tour tournaments.

ATP Tour tournaments

- ATP Tour Finals (singles & doubles)
- United Cup
- ATP Tour Masters 1000
- ATP Tour 500
- ATP Tour 250

ATP Challenger Tour tournaments

- Grand Slams
- Davis Cup
- ITF Men's WTT

1.02 Tournament Week

A. Main Draw. Each ATP Tour and ATP Challenger Tour tournament is assigned a specific tournament week on the calendar for scheduling of the main draws in singles and doubles commencing on a Monday and concluding on a Sunday, except as approved by ATP. ATP Challenger Tour tournaments scheduled in the weeks prior to the qualifying or first week of a Grand Slam tournament shall schedule their singles and doubles final on a date no later than the Saturday in the assigned week, unless otherwise approved by ATP.

Case: *A tournament, scheduled and announced for a Saturday final, during the week requests to move the final to Sunday (no weather issues), is this allowed?*

Decision: *Unless weather or other unavoidable circumstances cause the tournament to be extended to Sunday then no change to the original approved schedule may be made.*

B. Matches – Number of Sets.

- 1) Singles.** All matches, including finals, shall be the best of three (3) tie-break sets.
- 2) Doubles.** All matches, including finals, shall be two (2) tie-break sets with a deciding Match Tie-break (10 point) at one (1) set all. Games shall be decided using the No-Ad scoring method.

C. Monday Finals. No ATP Tour or ATP Challenger Tour tournament shall extend its tournament week for a Monday final without prior approval from ATP.

D. Qualifying.

A tournament may petition, forty-two (42) days prior to the event, for expansion of draw size as long as there is no change in the number of direct acceptances.

- 1) ATP Tour.** One (1) round per day except when weather or other unavoidable circumstances require two (2) rounds to be played on the same day.

I. ATP CIRCUIT REGULATIONS

2) ATP Challenger Tour.

a) **ATP Challenger 50-125.** One (1) round per day except when weather or other unavoidable circumstances require two (2) rounds to be played on the same day.

3) **General.** All tournaments must have a singles qualifying competition (unless there are sufficient places available in the main draw). The singles qualifying competition shall be a single elimination tournament.

a) All ATP Tour 250 events shall have a 16 draw qualifying.

b) ATP Tour Masters 1000 and ATP Tour 500 qualifying will be one half (1/2) the size of the main draw; i.e. a 56 main draw would have a 28 qualifying draw for the 7 qualifying positions.

4) **Location.** If the qualifying competition is not held at the same site as the main draw, the alternate site must have similar facilities, courts, staff, service and equipment. The qualifying competition may not be held at a site outside the metropolitan area of the main draw without prior written approval of ATP.

5) **Surface.** The qualifying competition shall be played on the same surface as the main draw. In situations beyond the control of the tournament, the Supervisor may approve the use of courts with a different surface.

1.03 Match Schedule Plan

Each tournament shall provide ATP, at least one hundred and eighty (180) days prior to the start of the tournament, a typed schedule that includes proposed daily starting times and number of courts to be used.

ATP Challenger Tour tournaments should submit their match schedule plan at least ninety (90) days prior to the start of the tournament.

1.04 Finals Options

A. General

1) When the singles and doubles finals are to be played on the same day, the doubles final shall be scheduled prior to the singles final, unless otherwise approved by ATP or due to player conflict.

2) When possible, there should be one Awards Ceremony that follows the completion of the singles final. It is mandatory that both singles and doubles finalist players participate in the awards ceremony, whether ceremonies are separate or combined.

B. Singles

1) If any ATP Tour tournament singles final is not played, the tournament may elect to replace it as follows:

a) Schedule a singles exhibition; or

b) Re-schedule the doubles final in its place; or

c) In the case where the doubles final has been completed or is in progress when it is discovered that there will not be a singles final, the tournament may elect to have the doubles finalists play a one (1) hour exhibition.

2) The awards ceremony shall take place immediately following the singles or doubles exhibition or following the doubles final if it has been re-scheduled.

I. ATP CIRCUIT REGULATIONS

C. Doubles.

The doubles final should be scheduled approximately two (2) hours prior to the published start time of the singles final, unless otherwise approved by ATP.

1) Exceptions shall be when one (1) or both of the singles finalists are also involved in the doubles final.

2) Tournaments may petition ATP Senior Vice President - Rules & Competition for an exemption to this provision; however, it is the responsibility of the tournament to show that there are valid reasons for justifying the exemption.

1.05 Change of Tournament Site

There shall be no change of a tournament site unless approved by ATP. A request to change a tournament site must be submitted in writing by the tournament and received by the appropriate ATP regional office no later than six (6) months prior to the first Monday of the event. Requests submitted after the deadline will only be considered if ATP determines there are extenuating circumstances out of the control of the tournament member. Any and all actual costs incurred by ATP during the site approval process shall be the responsibility of the tournament.

1.06 Commitment to Rules/ATP Official Rulebook

All ATP Tour and ATP Challenger Tour tournaments are subject to the jurisdiction of ATP and shall comply with, be bound by and conduct the tournament in accordance with ATP rules and regulations.

The online ATP Official Rulebook is the official version of the rules.

1.07 Commitment, Membership Obligations and Bonus Pool

A. Player Entry and Commitment to Rules

Any player who is included in the Pepperstone ATP Rankings for singles (hereafter referred to as "Pepperstone ATP Rankings") or the Pepperstone ATP Doubles Rankings and/or commits to enter or participates in any ATP Tour or ATP Challenger Tour tournament consents and agrees with the following:

1) To comply with and be bound by all of the provisions of the 2023 ATP Official Rulebook and ATP By-Laws (the "ATP Rules"), including, but not limited to, all amendments to ATP Rules.

2) The International Tennis Integrity Agency ("ITIA") may conduct anti-doping testing at ATP sanctioned events under the Tennis Anti-Doping Programme (the "TADP"), the full text of which can be found at <https://www.itia.tennis/>. ATP Tour, Inc. ("ATP") will honor and enforce any penalties or sanctions against players resulting from the TADP. The TADP shall apply to and be binding upon all players and shall govern all ATP-sanctioned events including ATP Challenger Tour events. Players shall submit to the jurisdiction and authority of the ITIA to manage, administer and enforce the TADP and to the jurisdiction and authority of the Anti-Doping Tribunal and the Court of Arbitration for Sport to determine any charges brought under the TADP. Players also consent to the release to ATP of their Anti-Doping results obtained by the ITIA at ATP events, including missed tests and/or filing failures.

I. ATP CIRCUIT REGULATIONS

- 3) To comply with and be bound by all of the provisions of the 2023 Tennis Anti-Corruption Program Rules, the full text of which can be found at: <https://www.itia.tennis/tacp/rules/>.
- 4) To review and agree to the terms and conditions contained in the Notice of Privacy Practices set forth in “Exhibit P - Privacy Notice (“HIPPA”).
- 5) Each calendar year all players shall, as a condition of entering or participating in any event organized or sanctioned by ATP, deliver to ATP a signed Consent and Agreement in the form set out in “Exhibit O - Consent and Agreement Form”.
- 6) For entry into an ATP Tour or ATP Challenger Tour tournament, all players must be an ATP Player Member (“Member”) or an ATP Registered Player. Wild cards are exempt from this provision.
- 7) All ATP Player Division I & II Members must, every two (2) years beginning 1 January 2016, submit an authorized physical examination form as shown in “Exhibit AA - Mandatory Physical” to be eligible to enter and compete on the ATP Tour or ATP Challenger Tour.
 - a) A pre-competition medical examination is mandatory and must be submitted prior to a player participating in his first event of 2023.
 - b) Members competing in their first ATP Tour or ATP Challenger Tour event after 1 January 2023 shall have thirty (30) days after the Member’s first match to complete and submit the medical examination forms. After the thirty (30) day period has ended the member will not be allowed to enter or compete in any ATP Tour or ATP Challenger Tour event until such time that the medical examination form has been submitted and accepted.
 - c) Members submitting a medical examination form which indicates they are “unfit to play” will be required to sign a release/waiver form before they will be allowed to compete in any ATP Tour or ATP Challenger Tour event. This form will be provided by ATP upon request.

B. Official Means of Communication

The [PlayerZone](#) and Tour Weekly are ATP’s official means of communicating with its player members. All players must stay informed of all information published by ATP through these official means of communication. Notification of any modifications, deletions or additions to the rules set forth in this Rulebook shall be through such means of communication and shall become effective upon their publication.

C. Commitment Player

A 2023 ATP commitment player is any player positioned in the Top 30 in the ATP 2022 Rankings (singles) as of November 7, 2022.

D. Commitment

The commitment for the commitment player is, the singles event of all ATP Tour Masters 1000 tournaments for which he is accepted, the Nitto ATP Finals (if qualified as a direct acceptance or designated as the alternate) and four (4) ATP Tour 500 tournaments, one (1) of which must be held following the US Open. For commitment and ranking purposes, the Monte Carlo Masters 1000 will be included in the minimum requirements for the 500 category.

I. ATP CIRCUIT REGULATIONS

E. Commitment Player Entry Exception – Top 30

Commitment players are automatically accepted into the main draw of all ATP Tour 500 events in which they have entered in a proper manner.

F. Good Standing

Players are in good standing with ATP if:

- 1) They pay all outstanding debts and obligations to ATP;
- 2) They participate in the Nitto ATP Finals, if qualified as a direct acceptance or designated as the alternate, unless otherwise approved by ATP;
- 3) They complete all Stars Program responsibilities, if applicable; and
- 4) They are otherwise confirmed to be in good standing by the ATP Chief Executive Officer (CEO).

Penalties for not being in good standing with ATP result in a player:

- 1) Not being eligible to participate in the bonus program;
- 2) Not being eligible to participate as a main draw entry in the following ATP Year;
- 3) Not being eligible to earn a year of credit toward ATP retirement program.

G. ATP Tour 500 Bonus Pool

Players that are in good standing and fulfill the ATP Tour 500 commitment requirements, shall be eligible for the ATP Tour 500 bonus pool. The order of standings will be based on total Pepperstone ATP Rankings points earned at the ATP Tour 500 events in 2023. The 2023 ATP Tour 500 bonus pool will be a total of USD \$1,300,000, with distribution to the top 5 players as follow:

Highest ATP Tour 500* Points Total	Amount (USD)
1	\$600,000
2	\$300,000
3	\$200,000
4	\$125,000
5	\$75,000

*For the avoidance of doubt, points from the Monte Carlo Masters 1000 tournament will not be included in the ATP Tour 500 bonus pool point calculation.

H. ATP Tour Masters 1000 & Nitto ATP Finals (“Finals”) Bonus Pool

General. The ATP Tour Masters 1000 and Nitto ATP Finals 2023 Bonus Pool will be USD \$20,000,000. The order of standings will be based on total Pepperstone ATP Ranking points earned across the ATP Tour Masters 1000 and Nitto ATP Finals in 2023. The bonus pool financial distribution is to be confirmed.

The bonus pool distribution payment to players will be made by the end of January 2024.

I. ATP CIRCUIT REGULATIONS

- 1) **Conditions of Eligibility for ATP Tour Masters 1000 and Nitto ATP Finals 2023 Bonus Pool.**
 - a) **Good Standing.** Player must be in good standing as defined in ATP Circuit Regulations section of the 2023 ATP Official Rulebook.
 - b) **Nitto ATP Finals.** All players must play, if qualified, in the Nitto ATP Finals. Alternates must appear and fulfill the requirements of the alternate, as determined by ATP. A player who is otherwise qualified but does not play in the Nitto ATP Finals may receive 80% of the bonus he earned (subject to Section 1.07.H.2) by appearing at the finals event to do promotional activities, as determined by ATP.
 - c) **Suspended player.** A player who is suspended from an event shall have the suspension count as a missed event for the bonus year in which the event is held.
 - d) **Not direct acceptance.** Any player who is not a direct acceptance to a mandatory ATP Tour Masters 1000 event shall not have that event count as a missed event.
 - e) **Promotional work.**
 - i) On-site promotional activities for withdrawn players are applicable for relief of fines bonus pool reduction recoupment pursuant to Section 1.07.H.2, and/or suspensions but shall not provide relief for the ranking penalty and shall count as a missed event.
 - ii) On-site promotional activities are not applicable to players missing the event due to being suspended.
- 2) Subject to the below, players that are in good standing shall be eligible for the bonus pool in this section based upon the total Pepperstone ATP Rankings points earned at the ATP Tour Masters 1000 and Nitto ATP Finals events in 2023. To be paid the full bonus pool amount set forth in this section a player must play all mandatory ATP Tour Masters 1000 events and the Nitto ATP Finals in which such player is a main draw direct acceptance.

ATP Tour Masters 1000 main draw direct acceptance players who fail to compete (for any reason) in an ATP Tour Masters 1000 event shall have their bonus pool amount reduced as follows:

Number of ATP Tour Masters 1000s Tournaments Missed	Bonus Pool Reduction (no on-site promotional activities)	Bonus Pool Reduction (1 on-site promotional activities requirement fulfilled)	Bonus Pool Reduction (2 on-site promotional activities requirements fulfilled)
1	25%	12.5%	N/A
2	50%	37.5%	25%
3	75%	62.5%	50%
4 or more	100%	100%	100%

In no event shall a player be able to recoup an amount greater than USD \$200,000 by fulfilling on-site promotional activities requirements.

- 3) A Player who, as of December 31, 2022, earned commitment reductions pursuant to the 2022 ATP Tour Official Rule Book shall continue to hold such commitment reductions and be bound by the applicable provisions of the 2022 ATP

I. ATP CIRCUIT REGULATIONS

Tour Official Rule Book relating to bonus pool and commitment penalties (for the avoidance of doubt, such player will not be able to replace zero (0) point ranking penalties for missing ATP Tour Masters 1000 tournaments for any reason). Notwithstanding the foregoing, a player may elect, in an irrevocable signed writing by the entry deadline of the first ATP Tour Masters 1000 in 2023, to permanently forfeit his earned commitment reduction(s). Such player will then be bound by the rules set forth in Section 1.07.H.2.

1.08 Unsatisfied Player Commitment Penalties

A. Failure To Participate in the Nitto ATP Finals

- 1) If a player qualified for the Nitto ATP Finals as a direct acceptance or was designated as the alternate, fails or refuses to participate in this event, except for bona fide injury or other reason which constitutes good cause, the player shall not be in good standing.
- 2) All direct acceptances and the alternate must appear at the site of the event(s) as determined by ATP and participate in the pre-tournament media conference. Failure to appear shall result in a penalty of five percent (5%) of total ATP prize money earned during the ATP Tour circuit year.

B. Review of Penalties for Breach of Commitment

Any player found to have committed a player commitment offense may petition the Appeals Tribunal for discretionary review. This written petition shall detail the basis for the appeal. The tribunal shall review the petition within twenty-one (21) days and, if necessary, designate a date, time and place for a hearing. At the hearing, the player shall present to the tribunal his respective positions on the facts. The tribunal may affirm, reverse or modify the penalty initially imposed by ATP.

1.09 Mandatory Player Meeting

Mandatory player meetings may be scheduled throughout the year as determined and announced in advance by ATP. These meetings are limited to and mandatory for all main draw singles and doubles players. Player members not entered will be sent the minutes.

The penalty for non-attendance is the following:

Year-end Pepperstone ATP Rankings	Amount (USD)
1-10	\$10,000
11-25	\$5,000
26-50	\$2,000
51-100	\$1,000
101 +	\$500

I. ATP CIRCUIT REGULATIONS

1.10 Player Eligibility/Player University/Physical Exam

- A.** Pursuant to ATP Bylaws, a player shall be entitled to become an active ATP player member as follows:
- 1)** Division I player membership in ATP shall be open to any individual who, on the date of his application for membership, shall be positioned among the top 200 players in the Pepperstone ATP Rankings or among the top 100 players in the Pepperstone ATP Doubles Rankings and pays ATP dues.
 - 2)** Division II player membership in ATP shall be open to any individual who does not qualify for division I membership and who, on and as of the date of his application for membership, shall be positioned among the top 500 players in the Pepperstone ATP Rankings or among the top 250 players in the Pepperstone ATP Doubles Rankings and pays ATP dues.
- B.** All division I ATP player members must attend an ATP player university within one (1) year after becoming a member.
- C.** All division I and II ATP player members must submit an authorized physical examination as specified in section 1.07.A.7).
- D.** Any ATP player who is eligible for division I membership and does not fulfill the obligations in subsection B and C above shall not be entitled to the privilege of membership.
- E.** All division I ATP player members must complete an ATP University refresher course two years after completing the ATP University as prescribed and designed by ATP. Any player Division I member who fails to complete the refresher course within the stated time period shall not receive the benefits of membership.

1.11 Waiver of Claims

All players entering ATP Tour and ATP Challenger Tour tournaments agree, as a condition of their entry, that for themselves, their executors, administrators, heirs and personal representatives, all claims of any kind, nature and description are waived, including past, present or future claims and injuries, if any, sustained in traveling to or from, or participating in, any ATP Tour or ATP Challenger Tour tournament, as against ATP, the tournaments concerned and the organizers and sponsors of the tournaments and circuits thereon.

1.12 Waiver/Player Publicity and Promotion

All players agree to the following:

- A.** I grant and assign to ATP and ATP Tour tournaments and ATP Challenger Tour tournaments in which I am or have been entered the right in perpetuity to record in tangible form and use my name, performance, likeness, voice, and biography, in any and all media (including the right to produce, display and otherwise use motion pictures, still pictures and live, taped or filmed television and other reproductions of me), solely for purposes of advertising and promoting ATP Tour, ATP Tour tournaments, ATP Challenger Tour tournaments and other events held as part of ATP. Any such use of my name, performance, likeness, voice or biography shall be without separate compensation to me or to my heirs, devisees, executors, administrators, legal

I. ATP CIRCUIT REGULATIONS

representatives or assignees. Nothing in this section shall permit ATP, or ATP Tour tournaments and ATP Challenger Tour tournaments to use my name, performance, likeness, voice or biography on any product, service or clothing, or in any manner that constitutes an endorsement of any product, service or company.

- B.** I agree to cooperate with the news media and to participate upon request in reasonable promotional activities of ATP and ATP Tour tournaments and events in which I am entered, subject to my reasonable availability to participate therein. My participation in any such promotional activities or other events shall not be represented to third parties as an endorsement by me of any product or company.
- C.** Any use of my name, likeness, signature, photograph, depiction or video (my "Likeness") on official ATP or ATP Tour branded merchandise (the "ATP Merchandise") shall be subject to my prior written approval. I agree that my response to any request for my approval will not be unreasonably delayed. With my prior written approval as to the items of ATP Merchandise, the use of my Likeness and the compensation for this use, I grant and assign to ATP the right to use my Likeness on ATP or ATP Tour Merchandise, provided that use of my Likeness on any such merchandise shall not conflict with or cause me to be in breach of any current endorsement contract to which I am bound. In the event ATP desires to use my Likeness on ATP or ATP Tour Merchandise, I acknowledge that I will receive a commission amount agreed upon in writing on any proceeds or revenue generated from such use.

1.13 Stars Program

Responsibilities

- A.** All players competing in the main draw of any ATP Tour tournament will be required, if asked, to participate in ATP sponsored activities.
- B.** Each player is obligated to provide up to two (2) hours each week as arranged by ATP staff, for a maximum of up to four (4) separate activities.
- C.** Each player, if requested, is obligated to conduct visits to private sponsor lounges. Tournaments shall instruct sponsors that no video or photos shall be taken if the player has a conflicting sponsor contract (i.e., is within the same product or service category), however, personal photos that do not include any corporate or product signage/identification and will not be used for a commercial purpose are allowed. Tournaments must ensure that no images or footage of any player visit shall be used by the sponsor for a commercial purpose (i.e., giving the appearance the player endorses a product or service) without the prior written consent of the player. No players are permitted to visit the sponsor lounge (or other location) of a company that offers betting on tennis.
- D.** Each player, if requested, is obligated to conduct visits to sponsor public booths except if the player has a conflicting sponsor contract (i.e., is within the same product or service category). Tournaments must ensure that no images or footage of such visits shall be used by the sponsor for a commercial purpose (i.e., giving the appearance the player endorses a product or service) without the prior written consent of the player. No players are permitted to visit the public booth (or other location) of a company that offers betting on tennis.

I. ATP CIRCUIT REGULATIONS

- E.** Each player, if requested, is obligated to participate in official tournament activities. However, Tournaments must ensure, pursuant to rule 1.13 B, that any player's participation in an official tournament activity shall not be conducted or promoted in a manner that would give the appearance that such player endorses a particular product, service or company without the prior written consent of the player. In addition, Tournaments must ensure that no images or footage of an official tournament activity shall be used by a sponsor for a commercial purpose (i.e., giving the appearance that a player endorses a product or service) without the prior written consent of each player.
- F.** Each player, if requested, is obligated to participate in up to two (2) sets of activities/ days for promotional purposes as arranged by ATP. Such activities/days may take place outside of an ATP Tour tournament week and/or location. Players and their agents will be consulted in advance to ensure that any such activities will not substantially intrude upon the player's schedule. Players and their agents will also be consulted with respect to the scope and substance of the activities to ensure that the player is comfortable with the proposed activities. ATP will cover all expenses incurred by a player while participating in any such activities.

1.14 Special Events - Exhibitions

- A.** This rule shall not apply to players outside the top thirty (30) as of November 7, 2022 (Commitment Players).

B. Restrictions

- 1) Special events are those other than Grand Slams, ATP Tour tournaments or ATP Challenger Tour tournaments. A player may not compete in a special event if it is scheduled as follows:
 - a) Within the tournament weeks of any ATP Tour Masters 1000 tournament, ATP Tour 500 tournament and the Nitto ATP Finals (singles or doubles). A player who has qualified for and chooses not to play in the ATP Tour Doubles Championship shall not be eligible for an exemption to play in any special event during that week.
 - b) Within thirty (30) days before or after the tournament weeks of any ATP Tour Masters 1000 tournament, ATP Tour 500 tournament, the Nitto ATP Finals (singles or doubles), if the special event is located within:
 - i) One hundred (100) miles or one hundred sixty (160) kilometers of the same; or
 - ii) The same market area of the city where the tournament is located as determined by the ATP CEO.
 - c) Within the period of any ATP Tour 250 tournament (qualifying competition and main draw) if the special event is located within:
 - i) One hundred (100) miles or one hundred sixty (160) kilometers of the same; or
 - ii) The same market area of the city where the tournament is located as determined by the ATP CEO.
 - 2) Within the tournament week of any ATP Tour or ATP Challenger Tour tournament in which he is entered including the Sunday night after such tournament final, except as otherwise expressly permitted in the following subsection C.
- C.** A player who is entered into an ATP Tour 250 tournament may participate in a special event on the Monday of such tournament, provided:

I. ATP CIRCUIT REGULATIONS

- 1) He has the permission of the Tournament Director of the ATP Tour 250 tournament he is entered in that week; and
 - 2) If he competes in a tournament during the preceding week, he agrees to complete the same if rain or other unavoidable circumstances delay the finals until Monday; and
 - 3) Such special event is not located within:
 - a) One hundred (100) miles or one hundred sixty (160) kilometers of the same; or
 - b) The same market area of the city where the tournament is located as determined by the ATP CEO; or
 - c) Such special event does not violate any of the other restrictions of this rule.
- D.** A player has the right to petition the ATP CEO or his designee for an exemption to these requirements unless otherwise specified above.

Case: *May a player, who is not a Commitment Player after losing, retiring or withdrawing from the qualifying, play in a special event held the following week-end?*

Decision: *Yes. However, the player must still ask for and receive a release from the Supervisor prior to participating in such special event. (Also see provisions listed in section 7.06 One Tournament Per Week and Exception)*

- E.** Violations of this section are subject to penalties described under the player Major Offense Conduct Contrary to the Integrity of the Game.

1.15 Promotional Fees

- A.** Except as expressly permitted in subsection B below, a player shall not accept money or anything of value that is given from any source, directly or indirectly, to influence or assure his competing in any ATP Tour tournament, or ATP Challenger Tour tournaments, other than prize money unless authorized by ATP.
- B.** ATP Tour 500 and ATP Tour 250 tournaments have the option to offer fees for promotional services. No other ATP Tour or ATP Challenger Tour tournament owner, operator, sponsor or agent is permitted to offer, give or pay money or anything of value, nor shall the tournament permit any other person or entity to offer, give or pay money or anything of value to a player, directly or indirectly, to influence or assure a player's competing in a tournament, other than prize money, unless authorized to do so by ATP.

1.16 Virtual Insertion

Each ATP Tour tournament shall comply with the rules established for virtual insertion. ("Exhibit E - Virtual Insertion")

1.17 Non-Exclusive Media Highlight Rights.

Each ATP Tour tournament shall each year promptly (within two business days) provide to ATP without charge existing footage of the tournament as ATP may request. Each ATP tournament hereby grants to ATP the non-exclusive right to broadcast, or permit to be broadcast, by any means, whether presently existing or hereafter creat-

I. ATP CIRCUIT REGULATIONS

ed, in perpetuity worldwide, a total each year of (i) fifteen (15) minutes of footage for ATP Highlight Show or any other programs, produced by or for ATP, which are primarily intended to promote the ATP tennis circuit and/or ATP; and (ii) three (3) minutes daily of footage for any local, regional, national or international news or sports news programming.

1.18 Quality/Broadcast

Each ATP Tour tournament shall comply with the Broadcast Quality Standards and regulation regarding Same Day Exclusivity, as per “Exhibit C”.

1.19 Seating and Attendance

A. ATP Tour tournaments shall have the following minimum Center court seating capacities, except as approved by ATP.

<u>Tournament Category</u>	<u>Center Court</u>	<u>Show Court 1</u>	<u>Show Court 2</u>	<u>Show Court 3</u>
ATP Tour Masters 1000 (Combined)	12,000	5,000	2,000	1,000
ATP Tour Masters 1000 (Outdoors)	10,000	3,000	1,000	
ATP Tour Masters 1000 (Indoors)	10,000	1,000	400	
ATP Tour 500 (Outdoors)	7,000	1,000		
ATP Tour 500 (Indoors)	6,000	500		
ATP Tour 250 (Outdoors)	3,500			
ATP Tour 250 (Indoors)	2,500			

B. The recommended attendance criteria for each ATP Tour tournament is as follows:

- 1) Minimum attendance for the week.
- 2) Average minimum attendance per session during the final weekend (Friday through Sunday) of play in excess of 75% capacity for the Center court.
Specific recommendations and methods are specified in “Exhibit D”.

1.20 Hotel Accommodations (Rooms)

All ATP Tour and ATP Challenger Tour tournaments shall provide hotel accommodations, subject to player obligations, as follows:

A. Tournament Obligations - ATP Tour Tournaments.

- 1) Each tournament shall provide one (1) complimentary double room (2 beds) for the use of each singles player including one (1) guest, at a hotel approved by ATP. The room must be occupied by the registered player who is responsible for charges resulting from any third or more person(s) staying in the room as well as all incidental costs charged to the room. At a minimum, ATP Masters 1000 and ATP 500 tournaments shall provide hotel accommodations in 4 Star hotels (5 Star hotels recommended) within thirty (30) minutes from the tournament site. ATP

I. ATP CIRCUIT REGULATIONS

Standards Committee (as defined in Exhibit K) approval is required for ATP 250 tournament hotel accommodations with ratings below 4 Stars and/or greater than thirty (30) minutes from the tournament site. ATP Masters 1000 tournaments are required to provide a dedicated tournament concierge and transportation desk at the main hotels if the tournament is using more than one (1) hotel as the official hotel

- 2) Tournaments using more than one (1) hotel as the official hotel may not make player hotel assignments based on a player’s entry into the event as a singles or doubles player.
- 3) Complimentary use of rooms for the tournament week is to be available for players as follows (accommodations begin no later than Monday).
- 4) Main draw players who are no longer eligible for tournament-provided hotel rooms shall receive the published tournament room rate if they extend their stay.
- 5) Main draw and qualifying players who have withdrawn on-site for medical reasons and who are examined by the on-site tournament Doctor, shall receive tournament provided hotel rooms through the night of the examination.

Case: A player plays and wins his first match. He then becomes ill and withdraws from the tournament. When does his hospitality end?

Decision: The player who retired from a match or withdrew after completing a match is entitled to the complete set minimum number of nights per the tournament category or through the night of the examination, whichever is later.

- 6) Players who travel to the event to complete their promotional activity requirement shall receive full hospitality from the day of arrival through the night following the completion of their promotional obligation.

a) ATP Tour Masters 1000 Tournaments Main Draw.

- i) **Singles:** Rooms for singles players should be available beginning on Friday and continuing for a minimum of seven (7) nights. Accommodations continue through the night that he plays his last match or until his seven (7) night minimum has been provided, whichever is later.
- ii) **Lucky Loser:** The number one (1) lucky loser to sign in the Lucky Loser list each day shall receive accommodation through each night he is eligible to be inserted into the draw. If the number one (1) lucky loser moves in, then the next player receives hospitality for that night and each night thereafter when he is the number one (1) lucky loser.
- iii) **Doubles:** Rooms for doubles players shall be available beginning Saturday. For doubles players who stay in individual rooms, hospitality shall be for a minimum of two (2) nights or through the night that the player plays his last match, whichever is later. A doubles player who shares a room with another main draw doubles player shall have a minimum of five (5) nights or through the night of that player’s last match, whichever is later.
- iv) **Sunday Start.** Where the main draw has been approved for a Sunday start, Hospitality shall begin one (1) day earlier than specified. This is applicable to both the singles and doubles main draw players.

NOTE: Singles Hospitality for 196-draw tournaments begin three days prior to the main draw. Doubles Hospitality for 96-draw tournaments begin two days prior to the start of doubles play.

I. ATP CIRCUIT REGULATIONS

b) ATP Tour 500 Tournaments Main Draw.

- i) **Singles:** Rooms for singles players should be available beginning on Friday and continuing for a minimum of six (6) nights. Accommodations continue through the night that he plays his last match or until his six (6) night minimum has been provided, whichever is later.
- ii) **Lucky Loser:** The number one (1) lucky loser to sign in the Lucky Loser list each day shall receive accommodation through each night he is eligible to be inserted into the draw. If the number one (1) lucky loser moves in, then the next player receives hospitality for that night and each night thereafter when he is the number one (1) lucky loser.
- iii) **Doubles:** Rooms for doubles players shall be available beginning Saturday. For doubles players who stay in individual rooms, hospitality shall be for a minimum of two (2) nights or through the night that the player plays his last match, whichever is later. A doubles player who shares a room with another main draw doubles player shall have a minimum of five (5) nights or through the night of that player's last match, whichever is later.
- iv) **Sunday Start.** Where the main draw has been approved for a Sunday start, Hospitality shall begin one (1) day earlier than specified. This is applicable to both the singles and doubles main draw players.

c) ATP Tour 250 Tournaments Main Draw.

- i) **Singles:** Rooms for singles players should be available beginning on Saturday and be available to each singles player for a minimum of five (5) nights, regardless of when the player is finally accepted into the main draw (singles qualifiers). Accommodations continue through the night that he plays his last match or until his five (5) night minimum has been provided, whichever is later.
- ii) **Lucky Loser:** The number one (1) lucky loser to sign the Lucky Loser list each day shall receive accommodation through each night he is eligible to be inserted into the draw. If the number one (1) lucky loser moves in, then the next player receives hospitality for that night and each night thereafter when he is the number one (1) lucky loser.
- iii) **Doubles:** Rooms for doubles players shall be available beginning Saturday.
For doubles players who stay in individual rooms, hospitality shall be for a minimum of two (2) nights or through the night that the player plays his last match, whichever is later. A doubles player who shares a room with another main draw doubles player shall have a minimum of five (5) nights or through the night of that player's last match, whichever is later.
- iv) **Sunday Start.** Where the main draw has been approved for a Sunday start, Hospitality shall begin one (1) day earlier than specified. This is applicable to both the singles and doubles main draw players.

d) ATP Tour Masters 1000, ATP Tour 500 and ATP Tour 250 Qualifying:

- i) Hotel accommodations for players in the singles qualifying shall be available to begin on the night before the start of qualifying competition and be available to each player through the night of the player's last qualifying match.
- ii) **Doubles 500 Qualifying.** Rooms for doubles qualifying players shall be available beginning on Saturday and continue through the night of their last match.

I. ATP CIRCUIT REGULATIONS

- iii) Successful qualifiers shall be afforded the same hotel accommodations as those offered to main draw singles players, however, the nights used under qualifying hotel accommodations shall count toward the tournament's minimum number of nights required.

B. Player Obligations - ATP Tour Tournaments

- 1) **Singles.** Each main draw player must make a hotel reservation no later than two (2) weeks prior to the first Monday of the tournament with either the hotel or the tournament, as specified on the tournament detail sheet. Reservation changes can be made up to two (2) days prior to the first day of the reservation except that a player still competing in either singles or doubles in the prior week's tournament must also confirm his reservations when travel plans are finalized. Failure to make or modify the reservation by the deadlines stated above shall result in the automatic loss of hospitality for that tournament week.
- 2) **Alternates.** Players that move into the main draw between the entry deadline and all day Thursday before the event, must notify the tournament two (2) days in advance if their arrival is later than Saturday, unless provisions specified above for players still competing apply. Players moving into the main draw after Thursday must notify the tournament of their arrival by 2:00 PM Eastern Time, USA on the Friday prior to the event. Players moving into the main draw after this deadline must confirm arrival day/date with the tournament as soon as possible.
- 3) **Doubles-Only Players.** Tournaments shall provide hospitality from Sunday. Players that wish to start their hospitality later than Sunday must make such change by 3:00 PM local time on the Saturday before the tournament starts. Players that fail to make their change by the deadline will be charged at the published rate for each night they are a no show. A refusal to pay shall result in automatic loss of hospitality for the remainder of the tournament week.
- 4) **Penalties for breaching obligation:**
 - a) Failure to make a reservation two (2) weeks prior to a tournament shall result in a player losing his hotel accommodation privileges for that tournament.
 - b) Player forfeits hotel accommodations for nights reserved but not used.
 - c) Player forfeits hotel accommodation privileges for four (4) consecutive tournaments when he either:
 - i) Does not pay all incidental costs charged to a room; or
 - ii) Does not personally stay in the room as required; or
 - iii) Does not cancel reservation(s) previously made at tournament hotel(s); or
 - iv) Damages a room or hotel facilities;
 - v) Exhibits unprofessional or abusive behavior towards any hotel employee or guest;
 - vi) Exhibits severe unprofessional behavior in or on the hotel premises and not specifically covered above.
- 5) **Other Reservations.** Players can request additional room reservations at the player rate if they contact the tournament no later than two (2) weeks prior to the start of the tournament.
- 6) **Qualifier Reservations.** Players participating in the qualifying competition who wish to receive a player rate at a tournament hotel must make a hotel reservation no later than five (5) days prior to the start of qualifying with either the hotel or the tournament, as specified on the tournament detail sheet. Reservation changes

I. ATP CIRCUIT REGULATIONS

can be made up to forty-eight (48) hours prior to the start of the reservation except that a player still competing in either singles or doubles in the prior week's tournament must confirm reservations when his travel plans are finalized.

C. Tournament Obligations - ATP Challenger Tour Tournaments

- 1) Complimentary hotel accommodations are mandatory at all ATP Challenger Tour tournaments as described in this section. Accommodations are defined as one (1) complimentary double room (2 beds) for the use of each player. The hotel, to be approved by ATP, shall be of a suitable international standard. At a minimum, hotel accommodations shall include complimentary breakfast with adequate breakfast options for the players (as determined by ATP). The room must be occupied by the registered player who is responsible for all incidental costs charged to the room and any charges resulting from any third or more person(s) staying in the room.
- 2) **Singles Main Draw.** Complimentary hotel accommodations shall be available for Main Draw Singles players from the first Saturday and for a minimum of five (5) nights, Saturday through Wednesday, or through the night of the player's last singles or doubles match, whichever is later.
- 3) **Qualifying and Lucky Losers.** Complimentary hotel accommodations shall be available for Qualifying and Lucky Losers singles players from Saturday through the night of the player's last match. Qualifiers and Lucky Losers accepted into the main draw shall be entitled to the same complimentary hotel accommodations as offered to main draw singles players; however, the nights used under qualifying hotel accommodations shall count toward the tournament's minimum nights entitlement.
- 4) **Doubles Main Draw.** For doubles-only players who stay in individual rooms, complimentary hotel accommodations shall be available from Sunday through the night of the player's last match. A doubles-only player who shares a room with another main draw doubles-only player shall have a minimum of six (6) nights, Sunday through Friday, or through the night of that player's last match, whichever is later.
- 5) Main draw and qualifying players who are no longer eligible for accommodations shall receive the published tournament room rate if they extend their stay within the date range of the tournament.
- 6) Main draw players (singles and doubles players, includes partner) who have withdrawn on-site for medical reasons and who are examined by the tournament Doctor shall receive complimentary hotel accommodations through the night of the examination.
- 7) Tournaments using more than one (1) hotel as the official hotel may not make player hotel assignments based on a player's entry into the event as a singles or doubles player.
- 8) Any ATP Challenger Tour tournament which has been approved for a Saturday start shall make complimentary hotel accommodations available one (1) day earlier than specified. At a minimum, any ATP Challenger Tour tournament which has been approved for a Tuesday start shall make complimentary hotel accommodations available one (1) day later than specified.
- 9) **Confirmation of Reservation.** ATP Challenger Tour Tournaments shall oversee requests for complimentary hotel accommodations and confirm reservations

I. ATP CIRCUIT REGULATIONS

through a platform designated by ATP, as specified on the ATP Challenger Tour tournament's detail sheet, to players stating the hotel name, address, telephone number, the check-in date and a notice that cancellations or changes can be made up to two (2) days prior to the reservation's start date.

- 10) The official hotel(s) shall be instructed to take a reasonable credit card guarantee from players and/or support team members at the time of check-in for any incidentals or room nights not covered under the ATP Challenger Tour tournament's obligation. ATP shall not be responsible for managing and/or covering any unpaid charges.

D. Player Obligations - ATP Challenger Tour Tournaments

- 1) **Singles Players Who Gain Acceptance In The Main Draw Through Advance Entry.** Each player must make their hotel room request no later than 11:59 p.m. (23:59) local time at the tournament ten (10) days prior to the tournament's start through the platform designated by ATP, as specified on the tournament's detail sheet.
- 2) **Doubles-Only Players Who Gain Acceptance In The Main Draw Through Advance Entry.** Each player must make their hotel room request no later than 11:59 p.m. (23:59) local time at the tournament on five (5) days prior to the tournament's start, through the platform designated by ATP, as specified on the tournament's detail sheet.
- 3) **Alternates.** Players moving into the qualifying or main draw between the deadlines outlined in sections D.1) and D.2) hereinbefore set forth and four (4) days prior to the Tournament Monday shall make their room request no later than 11:59 p.m. (23:59) local time at the tournament four (4) days before the Tournament Monday through the platform designated by ATP, as specified on the tournament's detail sheet, unless provisions for players still competing hereinafter set forth apply. Players moving into the qualifying or main draw after this deadline shall make their room request and notify the tournament of their arrival date without delay, through the platform designated by ATP, as specified on the tournament's detail sheet, unless provisions for players still competing hereinafter set forth apply.
- 4) **Doubles-Only Players Who Gain Acceptance In The Draw Through On-Site Entry.** Players must make their hotel room request and notify the tournament by 3:00 p.m. (15:00) local time on Saturday at the tournament, through the platform designated by ATP, as specified on the tournament's detail sheet.
- 5) **Singles and Doubles.** Players accepted both in the singles and doubles event shall comply with the room request deadline of whichever (singles or doubles) they gain acceptance in first.
- 6) **Players Still Competing In The Previous Week's Tournament.** A player still competing in either singles or doubles in the prior week's tournament must keep the tournament informed if his reservation(s) may change and confirm the final arrival date with the tournament when his travel plans are finalized.
- 7) **Cancellation Or Change of Reservation.** Any player who needs to cancel or amend his reservation to a later date must do so by 6:00 p.m. (18:00) tournament local time four (4) days prior to the tournament's start through the platform designated by ATP, as specified on the tournament detail sheet. Players withdrawing after the preceding sentences deadline, must cancel their reservation as soon as possible after the withdrawal.

I. ATP CIRCUIT REGULATIONS

- 8) Notwithstanding the provisions above, any cancellation or change of reservation less than two (2) days before the start of the reservation, is subject to ATP approval.

E. Penalties for Breaching Obligation:

- 1) For the avoidance of doubt, forfeiture of hotel accommodations privileges covers the player, his support team member and/or doubles partner. ATP, in its sole discretion, shall determine if a player forfeits any hotel accommodations privileges.
- 2) Failure to make a reservation by any of the deadlines hereinbefore set forth shall result in that player's forfeiture of hotel accommodations for the tournament's week.

Case: A player accepted into the Singles Main Draw of a Challenger Tour event did not make his hotel reservation by the deadline and the tournament decided to withdraw his hotel accommodation privileges. Player signs in on-site for Doubles on Saturday. Is he entitled to hotel accommodations as a Doubles player?

Decision: No, the player forfeits hotel accommodation privileges for the tournament week (singles and doubles).

- a) Failure to make a reservation change by the deadline shall result in that player's forfeiture of hotel accommodations for nights reserved but not used. In addition, ATP, on behalf of the tournament, shall have the right to charge the player at the official tournament hotel's published rate for each night he did not use the room. Any refusal to pay shall result in that player's forfeiture of hotel accommodations for the tournament's week and may be subject to provisions under the Code of Conduct.
- b) Failure to cancel a reservation by the set deadline, including for players who have withdrawn on-site at a tournament in the previous week, shall result in that player being charged at the published hotel room rate for each night he did not use the room. Any refusal to pay shall be subject to provisions under the Code of Conduct in addition to settling the hotel charge.
- c) A player may be subject to the provisions under the Code of Conduct if:
- i) Does not pay 'no show' charges, including any applicable taxes; or
 - ii) Does not pay all incidental costs charged to a room; or
 - iii) Does not personally stay in the room as required; or
 - iv) Damages a room or hotel facilities; or
 - v) Exhibits unprofessional or abusive behavior towards any hotel employee or guest; or
 - vi) Exhibits severe unprofessional behavior in or on the hotel premises and not specifically covered above.

The payment of any monetary fines under the provisions of the Code of Conduct shall apply in addition to settling any outstanding charges and/or damages.

- d) Players shall have the right to appeal any of the above fines and charges which must be submitted in writing to the ATP Fines Committee.

II. BRANDING

2.01 Identification - ATP Tour Tournaments

A. Each ATP Tour tournament shall identify itself clearly to the public as being part of the ATP Tour and shall cooperate fully with ATP in furthering public awareness of the ATP Tour. Participation in the ATP Tour shall not restrict the right of the tournament to obtain individual sponsorship or to retain its usual title.

B. **Trademark and Logo Identification.** Each ATP Tour tournament and ATP Challenger Tour tournament shall comply with the terms and conditions for the use of the ATP Tour and the ATP Challenger Tour trademark and logo outlined in "Exhibit B and G".

C. Except as otherwise approved by ATP, each ATP Tour tournament shall comply with the ATP Tour Branding Application Requirements and shall assume all costs associated with such compliance. Branded nets and microphone flags will be provided, without cost, to all tournaments by ATP. ATP Tour and ATP Challenger Tour Application Requirements will be provided to each tournament by ATP.

1) ATP Tour Official Tournament Stamps: Application Rules ("Exhibit A.01")

All ATP Tour tournaments must display the appropriate ATP Tour Official Tournament Stamp (Masters 1000, 500, or 250) on all compulsory materials containing the tournament logo, as identified in the rules below. The tournament logo is the official identity of the tournament that includes the tournament name. When a text alternative to the tournament logo is used, it will be regarded as the tournament logo and the rules below will continue to apply. When a tournament logo is used repeatedly, or if both tournament logo and tournament title are used, application rules will apply to the largest tournament logo or title. For multiple page external documents, the ATP Tour Official Tournament Stamp must be applied on the front page in accordance with the rules below.

a) Size Relationship

i) Men only events ("Exhibit A.02")

The ATP Tour Official Tournament Stamp must be a minimum of 60% of the surface area of the tournament logo or tournament title, whichever is larger. This is subject to the minimum size rules for the ATP Tour Official Tournament Stamps below.

ii) Combined events ("Exhibit A.03")

The ATP Tour Official Tournament Stamp should be presented with the WTA logo to communicate to audiences that the tournament is part of both tours.

• Size relationship: WTA logo

The ATP Tour Official Tournament Stamp must be the same visual size (cover the same surface area) as the WTA logo.

• Size Relationship: Tournament Logo

When the ATP Tour Official Tournament Stamp is used in conjunction with the WTA logo, the Official Stamp must be at a minimum equal size to the WTA logo or 30% of the surface area of the tournament logo, whichever is greater. This is subject to the minimum size rules for Official Stamps below.

iii) Minimum Size

To ensure the ATP Tour Official Tournament Stamps are reproduced to best effect, the tournaments must adhere to the application rules stated in i) and ii) above or the following minimum sizes, whichever is greater:

II. BRANDING

In quality print	9mm wide
In newsprint	13mm wide
On screen	45 pixels wide

Size Requirements

Below are the minimum size requirements for using the ATP Tour Official Tournament Stamps on printed materials.

A7	9mm wide
A6	11mm wide
A5	14mm wide
A4	18mm wide
A3	26mm wide
A2	36mm wide
A1	51mm wide

In non 'A' format communications the width of the ATP Tour Official Tournament Stamps should be no smaller than 6% of the longest side of the layout.

b) Positioning ("Exhibit A.04")

i) Proximity to the tournament logo

The ATP Tour Official Tournament Stamp must be placed closest to the tournament logo. No sponsor (with exception of the presenting sponsor), federation, series logo or any other logo may be closer to the tournament logo than the ATP Tour Official Tournament Stamp. Tournament logos cannot include any series name, federation name or any other name or brand mark.

ii) Proximity to Sponsor logos

The ATP Tour Official Tournament Stamps are used as an endorsement of the quality and authenticity of a tournament and its inclusion within the ATP Tour. The ATP Tour Official Tournament Stamps should never be placed alongside sponsor logos or added to sponsor logo strips.

c) Exclusion Area ("Exhibit A.05")

i) Exclusion Area 1: For graphics, images, text, WTA Tour and tournament logos (including 'presented by' sponsor)

A minimum exclusion area equal to the height of the ATP type has been established around the ATP Tour Official Tournament Stamps. No graphics, images, text, WTA Tour or tournament logos must appear in this area. This exclusion area must be maintained.

ii) Exclusion Area 2: For sponsor, federation and series logos

A minimum exclusion area equal to the width of two ATP Tour Official Tournament Stamps has been established around the ATP Tour Official Tournament Stamps. No sponsor, federation or series logos must appear in this area. This exclusion area must be maintained.

d) Acceptable and unacceptable applications ("Exhibit A.06.1 to A.06.6")

2) ATP Tour Official Tournament Stamps : Compulsory Applications

An ATP Tour tournament must identify itself as an ATP Tour event by applying the appropriate ATP Tour Official Tournament Stamp, in accordance with the rules listed in section 1) above, in the following compulsory applications:

a) Promotion

i) Advertising

The ATP Tour Official Tournament Stamp must be applied to all tournament advertising communications.

II. BRANDING

ii) Communication / Administration / Presentations

The ATP Tour Official Tournament Stamp must be applied to all external tournament communications. To include but not limited to: stationery, memos, powerpoint presentations, documents and press releases. For multiple page documents, the ATP Tour Official Tournament Stamp needs only to be applied on the front page that contains tournament logo or tournament name.

iii) Website / Other Digital Products ("Exhibit A.07")

The ATP Tour Official Tournament Stamp must be displayed on all pages of the official tournament website intended for large format display (tablet and desktop). The official stamp must be located within the upper 20% of the pages within the masthead area as the closest logo to the tournament logo. The ATP Tour Official Tournament Stamp should be no smaller than 45 pixels wide for websites and other digital products intended for large format display. For mobile website display the official stamp must be used in a way that clearly identifies the particular tournament category.

The official stamp must also be prominently displayed on all other digital products, including social media landing pages and apps for both mobile and tablet devices. Given the huge differences and ever evolving nature of these devices and applications, the official stamp must be used in a way that clearly identifies the tournament as an ATP Tour event and its respective category. See exhibit for examples.

iv) Promotional Materials

The ATP Tour Official Tournament Stamp needs only to be applied to the front page of all promotional communications. To include but not limited to: tournament programs, daily programs, leaflets, draw sheets, announcements and notices. For multiple page documents, the ATP Tour Official Tournament Stamp need only be applied on the front page that contains tournament logo or tournament name.

v) ATP Advertisement.

Three (3) full pages of ATP Tour advertisements must be included in the tournament program with two (2) of the three (3) pages within the first third (1/3) of the tournament program to be used to promote and advertise the ATP Tour. (The three (3) pages are separate from any other page requirements specified in an ATP Sponsorship Agreement between a tournament and ATP).

ATP will supply the advertisement and it shall be printed without expense to ATP. One (1) of the three (3) pages must be the doubles program ad as furnished by ATP.

Violations.

Violation of this section shall subject a tournament to a fine under the Tournament Standards Violations Fines Table (as defined in Section 8.02).

Note: When possible, tournaments will be given notice of and the opportunity to correct any issues that would put them in a violation of the above rules.

b) Compulsory Application: On-site

i) Entrance

The ATP Tour Official Tournament Stamp must be displayed at all entrances to the tournament that include the tournament logo or the tourna-

II. BRANDING

ment title, unless otherwise approved by ATP. To include but not limited to: car parks, main stadium, press, player and VIP entrances.

ii) **Scoreboards / Drawboards (“Exhibit A.08”)**

If a scoreboard / drawboard includes the tournament logo or tournament title then the ATP Tour Official Tournament Stamp must be displayed.

iii) **Singles / Doubles Leader Boards (See ATP Tournament Guidelines)**

The current standings of the 2023 Pepperstone ATP Rankings and 2023 Pepperstone ATP Doubles Team Rankings must be placed prominently in the tournament stadium grounds. Artwork will be provided by ATP. Preferred position is in the main welcome area.

iv) **Vehicles**

The ATP Tour Official Tournament Stamp must be applied to any vehicle that displays the tournament logo or the tournament title.

c) **Compulsory Application: On-court**

i) **The Court**

No commercial branding (sponsor, series or federation), court manufacturer branding or any other mark may be placed on the surface of the court, with the exception of “Host Locality” (See 3.b.) and the provisions outlined below unless otherwise approved by ATP.

Provisions for commercial branding placement:

1. ATP approval required for printing or insertion on the court surface of any sponsor logo at any tournament (ATP Tour Masters 1000, 500, 250 and Challenger Tour).
2. The sponsor logo can be inserted virtually (technology to be approved by ATP) or printed on the surface.
3. Only 1 sponsor logo per court/tournament.
4. Logo can be placed on all courts for all matches.
5. Sponsor logo must be on the side of the double alley opposite to the chair umpire where the host locality logo can be featured
6. On clay the sponsor logo will replace one of the host locality signs. Only in exceptional cases ATP may approve the sponsor logo to be placed below and in addition to the second host locality at the extension of the service line opposite to the Chair Umpire (in case by contract the tournament must display 2 host locality logos).
7. The sponsor logo must be the same size as the host locality logo (40cm high maximum and 40cm from the doubles line).
8. The sponsor logo must be white.

ii) **Net (“Exhibit A.10”)**

All ATP Tour tournaments must use the ATP Tour branded net on all courts, as determined and provided by ATP. Branded nets will be provided, without cost, to all tournaments by ATP. No commercial or other branding is allowed on the net or net posts other than that specified or otherwise approved solely by ATP.

Violation of this requirement (c. ii.) shall subject a tournament to a fine under the Tournament Standards Violations Fines Table.

Note: When possible, tournaments will be given notice of and the opportunity to correct any issues that would put them in a violation of the above rules.

• **Net Example 1: Net without sponsor branding**

At tournaments where the ATP Tour premier partner branding is not

II. BRANDING

used, ATP net signage shall be displayed on the left and right sides of the net on all match courts.

• **Net Example 2: Net with sponsor branding**

At tournaments where the ATP Tour premier partner branding is used, net signage will be displayed on the left and right sides of the net on all match courts.

• **Positioning of net signage (ATP or ATP Tour premier partner)**

- o For singles matches using a doubles net, net signage must be centered between the singles stick and the net post.
- o For singles nets, net signage must be centered between the singles sideline and the net post.

iii) **ATP Supervisors / ATP Designated Chair Umpires**

The officiating uniform provided by ATP must be worn. No other commercial branding may be applied to the uniform without prior approval from ATP.

iv) **ATP Physiotherapists**

The uniform provided by ATP must be worn.

v) **Chair Umpire Microphones**

An ATP Tour microphone cover must be used on the Chair Umpire’s microphone. The appropriate ATP Tour Official Tournament Stamp must appear on all four sides. Microphone covers will be provided by ATP.

Violations.

Violation of this section (with the exception of c. ii) shall subject a tournament to a fine under the Tournament Standards Violations Fines Table.

Note: When possible, tournaments will be given notice of and the opportunity to correct any issues that would put them in a violation of the above rules.

d) **Compulsory Application: Media & Broadcast**

i) **Media Backdrop (“Exhibit A.11”)**

The ATP Tour Official Tournament Stamp must be displayed on the official tournament media backdrop in such a way that it is clearly visible during the actual interview, in accordance with size, positioning and exclusion area rules.

ii) **Interview Room Microphone**

An ATP Tour microphone cover must be used on all player interview microphones. The appropriate ATP Tour Official Tournament Stamp must appear on all four sides. Microphone covers will be provided by ATP.

iii) **Broadcast**

The ATP Tour Official Tournament Stamp must be displayed on all tournament broadcasts on any screen where the tournament logo is featured, unless otherwise approved by ATP.

Violations.

Violation of this section shall subject a tournament to a fine under the Tournament Standards Violations Fines Table.

Note: When possible, tournaments will be given notice of and the opportunity to correct any issues that would put them in a violation of the above rules.

3) **ATP Tour Branding: Optional Applications**

An ATP Tour tournament may wish to further identify itself as an ATP Tour event by applying the appropriate ATP Tour Official Tournament Stamp in the following

II. BRANDING

optional applications:

a) Court Surface Color (“Exhibit A.12”)

The preferred hard court surface color for all ATP Tour events is a match to PMS 281, to be used inside the court lines and a match to PMS Cyan, used outside the court lines.

b) Court Host Locality (“Exhibit A.13.1 to A.13.2 ”)

Tournaments may feature only the name of the country, city or region (example: Germany, Munich or Bavaria) on the court surface, subject to the placement and size restrictions set forth below. The preferred font is FS Industrie CD-Bold, however, tournaments may use the official logo or font of the host country, city or region; all versions other than the preferred font must receive the prior approval of ATP. The on-court logo must be consistent with the texture and feel of the court surface so as not to affect play or be a safety hazard, as further described below.

i) Host Locality Option 1

a) Clay Courts:

Host country/city/region must be written in upper case if using the preferred font and all versions must be in white on one or both sides of the court and is to be centered between the net post and the service line.

Host country/city/region can be displayed on one or two lines, facing the main camera.

Maximum text height is 40cms (16”).

Text should be placed 40cms (16”) from the doubles line.

When text is displayed on two lines, they should together be centered between the net post and the service line.

Line spacing should be 20cms (8”).

Host country/city text should be elongated by 27% for improved television visibility.

On a clay surface, the text must not protrude above the surface of the court.

b) Hard Courts:

Host country/city/region must be written in upper case if using the preferred font and all versions must be in white on one or both sides of the court at the service line.

Host country/city/region can be displayed on one or two lines, facing the main camera.

Maximum text height is 40cms (16”).

Text should be placed 40cms (16”) from the doubles line.

When text is displayed on two lines, they should together be centered on the service line.

Line spacing should be 20cms (8”).

Host country/city text should be elongated by 27% for improved television visibility.

The material used for the name, on a hard court, must be of the same material and texture as the court surface to ensure safe footing for the players.

ii) Host Locality Option 2 (Not for use on clay)

Host country/city/region must be written in upper case, if using the preferred font, in white on both sides of the court, centered between the singles sidelines.

Host country/city/region must be displayed on one line, facing the

II. BRANDING

main camera.

Maximum text height is 50cms (20”).

The closest distance permitted from the baseline is 300cms (9’ 10”).

The material used for the name, on a hard court, must be of the same material and texture as the court surface to ensure safe footing for the players.

c) Court Backdrops – Color (“Exhibit A.14)

The preferred backdrop color for all ATP Tour tournaments is the closest match to PMS 281.

i) Lettering.

PMS Cool Grey 5 is the preferred color used for lettering. If the tournament selects color combinations other than those outlined in the previous sentence, then such color combinations may not include shades of white, yellow or other light colors and must be approved in advance by ATP.

ii) Rotating / LED Banners.

Background and lettering on Rotating / LED Banners should be consistent with the color of the back walls. Rotating / LED Banners can only change between games.

d) Court Backdrops – ATP Tour Official Tournament Stamps (“Exhibit A.14”)

i) ATP Tour Men Only Events.

The ATP Tour Official Tournament Stamp may be used in the left and right corners of the backdrop, facing the main camera. If a tournament decides to do so, the ATP Tour Official Tournament Stamp must be placed in a non-obstructed position, away from ball persons, scoreboards or corner camera positions. The ATP Tour Official Tournament Stamp must be 40% of the height of the board, and placed in the top 60% of the board.

ii) Combined Events.

If the WTA logo is placed on the back wall of the court then the ATP Tour Official Tournament Stamp must also be placed on the back wall in equal size and with equal television visibility.

e) On-court Ball Persons / Linesmen

If a tournament wishes to use the appropriate ATP Tour Official Tournament Stamp on the uniforms of ball persons or linesmen, the application of the ATP Tour Official Tournament Stamp must be approved in advance by ATP.

f) Merchandise

The ATP Tour Official Tournament Stamp may be used on tournament merchandise only in conjunction with the official Tournament logo, provided that such a use complies with the terms and conditions set forth in the ATP Rulebook. Specific application requirements will be provided to tournaments separately. Any and all applications must be approved by ATP’s retail merchandise consultant, at a minimum three (3) months in advance. No approval is required if merchandise is obtained from an approved ATP licensee.

2.02 Identification - ATP Challenger Tour Tournaments

A. Challenger Tournaments. (“Exhibit A.15”)

Each Challenger tournament shall identify itself as an ATP Challenger Tour tournament and shall use the ATP Challenger Tour Brand Mark as presented in “Exhibit A.15” (the “Brand Mark”). Tournaments are prohibited from using “ATP” as part of the tournament name. The Challenger Brand Mark is mandatory.

II. BRANDING

1) Size Relationship.

The ATP Challenger Brand Mark must be a minimum of 60% of the surface area of the tournament logo or tournament title, whichever is larger.

2) ATP Challenger Tour Brand Mark: Compulsory Applications

An ATP Challenger Tour tournament must identify itself as an ATP Challenger Tour tournament by applying the Brand Mark in the following compulsory applications:

a) Website / Other Digital Products (“Exhibit A.16”)

The Brand Mark must be displayed on all pages of the tournament website and other digital products intended for large format display, e.g., desktop, laptop, tablet computers, and be located within the upper 20% of the pages within the masthead area as the closest logo to the tournament logo. It must not be smaller than 112 pixels wide for websites and other digital products intended for large format display. For mobile websites and other digital products intended for small format display, e.g., mobile handsets, follow the 2.01.C. 1) a) Size Relationship rule.

Note: “ATP” is prohibited from use in any web address or URL.

b) Program

The Brand Mark must be displayed on the cover in the top 40%. It must not be smaller than 28mm (1.1”) wide.

c) Drawsheets

The Brand Mark must be displayed in the top 40%. It must not be smaller than 28mm (1.1”) wide.

d) Entrance

The Brand Mark must be displayed prominently at the main entrance to the tournament.

e) Court Backdrops (“Exhibit A.17”)

The Brand Mark must be displayed in the left and right corners of the court backdrops (back fences or back walls), it must not be used smaller than 60cm (23.625”) wide. Brand Marks must be placed in a non-obstructed position.

f) Advertising

The Brand Mark must be applied to any advertising where the tournament logo is featured.

g) On-Site

The Brand Mark must be applied to any on-site drawboards, scoreboards, vehicles, banners, flags or signage featuring the tournament logo.

h) Media Center

The Brand Mark must be displayed on tournament media backdrops.

i) Broadcast

The Brand Mark must be displayed on any tournament broadcasts.

Violations.

Violation of this section shall subject a tournament to a fine up to \$10,000 for each violation. In cases that are flagrant and particularly injurious to the success of the ATP Tour, the Senior Vice-President Rules & Competition may refer the matter to the ATP Challenger Committee for further action which could include additional fines and/or loss of sanction.

II. BRANDING

3) ATP Challenger Tour Brand Mark: Optional Applications

An ATP Challenger Tour tournament may wish to identify itself as an ATP Challenger Tour event by applying the Brand Mark in the following optional applications:

a) Merchandise

The Brand Mark may be used on tournament t-shirts and sweatshirts (not colored shirts). The Brand Mark must not exceed 100mm (3.937”) wide. Written approval is required from ATP if producing these items yourself. No approval is required if merchandise is obtained from an approved ATP licensee.

b) On-court Ball Persons / Linesmen

If a tournament wishes to use the appropriate ATP Challenger Tour Brand Mark on the uniforms of ball persons or linesmen, the application of the ATP Challenger Tour Brand Mark must be approved in advance by the ATP.

B. ATP Challenger Tour Tournaments - The Court

No commercial branding (sponsor, series or federation) or any other mark may be placed on the surface of the court, except as follows:

1) “Host Locality” (See 2.01 C. 3.b. and “Exhibit A.13.1 to A.13.2”).

2) On-Court Surface Commercial Branding. ATP Challenger Tour tournaments are allowed* to place a commercial branding on the court surface. The size and placement must be approved three (3) months in advance by ATP. (See “Exhibit A.13.3”)

*ATP reserves the right to use this Commercial branding position for an ATP Challenger Tour sponsor (at Regional level, i.e., multiple tournaments in the same region and **Global** level, i.e., all tournaments globally). Tournaments may be approved to use this commercial location in the absence of an ATP Challenger Tour sponsor.

II. BRANDING

III. FINANCIAL

3.01 Composition of Commitment

Each tournament's financial commitment is composed of on-site prize money and tournament fee obligations unless otherwise approved by ATP.

3.02 Currency

All references to money are expressed in United States Dollars (USD) and Euros (EUR), unless otherwise designated. Tournament fees, fines and other amounts payable to ATP are payable in USD or EUR.

3.03 Default of Prize Money Payments

Any ATP Tour or ATP Challenger Tour tournament that defaults in payment of prize money, tournament fee or any other payments due to ATP may have its membership status (sanction status if ATP Challenger Tour tournament) changed subject to ATP Bylaws.

3.04 Fee Obligation

A. ATP Tour and ATP Challenger Tour tournaments must pay to ATP as part of their total financial commitment the following fees based on prize money level and tournament classification, unless otherwise determined by ATP:

ATP Tour Masters 1000

- Service Fee
- Category Protection Fee
- Extra Week Fee

ATP Tour 500

- Service Fee
- Category Protection Fee

ATP Tour 250

- Service Fee

ATP Challenger Tour

- Tournament fees shall be 5% of total prize money.

B. All fees shall be due and payable as follows:

1) ATP Masters 1000 and ATP 500 Tournaments:

a) Six (6) months prior to the first day of the tournament, the Advance Fee is due:

ATP Tour Masters 1000	\$60,000/€51,000
ATP Tour 500	\$50,000/€42,500

b) On the first day of the tournament, the balance of unpaid fees is due and payable.

2) ATP 250 Tournaments:

On the first day of the tournament, the total fee is due and payable.

3) ATP Challenger Tour Tournaments. The full fee is due with the tournament application.

4) Late Payments. Fee payments not received by due dates are subject to an initial 2% late fee, followed by a subsequent 2% late fee every 30 days.

III. FINANCIAL

3.05 Fees/Other Payments

A. All fees and monies due to ATP are to be sent by wire in USD or EUR.

1) U.S. Dollar payment by wire

Bank: Wells Fargo Bank, NA
420 Montgomery Street
San Francisco, CA 94163
United States of America
Swift/BIC Code: WFBIUS6S
Account Number: 2130600027348
Routing Number (Domestic Banks): 121000248
Beneficiary: ATP TOUR INC.
Reference: Tournament Name & Invoice Number

2) Euro payment by wire

Bank: Wells Fargo Bank, NA - London
One Plantation Place
30 Fenchurch Street
London, EC3M 3BD
Swift/BIC Code: PNBPG2L
IBAN: GB31 PNB3 1656 7121 4741 66
Account: 21474166
Beneficiary: ATP TOUR INC.
Intermediary Bank: ING BELGIUM SA
BBRUBEBB010
Reference: Tournament Name & Invoice Number

B. Any amounts (e.g. player fines, non-member service fees, air-tickets) collected or owed by the tournament to ATP must be remitted to ATP.

3.06 Insurance

A. Each ATP Tour and ATP Challenger Tour tournament shall obtain and maintain general liability insurance or the equivalent thereof, with an insurance carrier maintaining a financial rating of "A" by AM Best and acceptable to ATP.

- 1) Masters 1000 events shall maintain a minimum limit of \$10,000,000 USD.
- 2) ATP Tour 500 and ATP Tour 250 events shall maintain limits of not less than \$5,000,000 USD.
- 3) ATP Challenger Tour events offering prize money of \$100,000 and above shall maintain limits of not less than \$€1,000,000 in coverage.
- 4) ATP Challenger Tour events offering prize money less than \$100,000 shall maintain limits of not less than \$€500,000 in coverage.
- 5) The liability insurance shall include bodily injury and property damage liability, personal injury, participant legal liability, hired and non-owned auto and contractual liability coverage.
- 6) The tournament liability insurance shall name ATP Tour, Inc. (a United States Corporation), its director and officers, employees, agents as additional named insureds with respect to any claim or suits brought against ATP, its officials, employ-

III. FINANCIAL

ees, agents, regardless of the court of jurisdiction, arising out of the negligence of the tennis tournament, its directors or representatives.

- 7) Coverage will include volunteers, on-court officials and ball persons as "named insureds" under the policy.

B. Each ATP Tour and ATP Challenger Tour tournament is responsible for determining whether applicable worker's compensation statutes apply to injuries sustained by volunteers, sub-contractors, on-court officials or ball persons. In the absence of a worker's compensation coverage requirement, it is recommended that the tournament purchase excess medical insurance for the event to provide medical payments coverage to injured volunteers, on-court officials or ball persons involved in the event.

C. All such insurance shall provide, not less than thirty (30) days, prior written notice to ATP of cancellation.

D. Each ATP Tour and ATP Challenger Tour tournament shall furnish to ATP no later than sixty (60) days prior to such tournament a certificate of insurance from such insurance carrier certifying compliance with the above requirements.

3.07 Letter of Credit - New/Conditional Tournaments

Unless otherwise determined by ATP, each ATP Tour tournament with conditional membership status must submit to ATP within the time period required, an approved irrevocable Letter of Credit, in form and substance, satisfactory to ATP, from an ATP approved bank in the amount of the on-site prize money. Such Letter of Credit must have an expiration date no earlier than one (1) month after the last scheduled day of ATP event.

3.08 Prize Money

A. All prize money due to ATP is to be sent by wire in USD or EUR.

1) U.S. Dollar payment by wire

Bank: BNP PARIBAS
1 boulevard des Moulins
98000 Monaco
Swift/BIC Code: BNPAMCM1XXX
IBAN Number: MC58 3000 4091 7000 0140 0573 253
Account Number: 00014005732
Beneficiary: ATP TOUR PRIZE MONEY
201 ATP Tour Boulevard
Ponte Vedra Beach, FL 32082

Intermediary Bank: BNP PARIBAS USA – NEW YORK
787 Seventh Avenue
New York, NY 10109
Swift/BIC Code: BNPAUS3N

Reference: Tournament Name & Invoice Number

III. FINANCIAL

2) Euro payment by wire

Bank: BNP PARIBAS
1 boulevard des Moulins
98000 Monaco
Swift/BIC Code: BNPAMCM1XXX
IBAN Number: MC58 3000 4091 7000 0101 1541 076
Account Number: 00010115410
Beneficiary: ATP TOUR PRIZE MONEY
201 ATP Tour Boulevard
Ponte Vedra Beach, FL 32082
Reference: Tournament Name & Invoice Number

B. General

1) ATP Tour

- a) Prize money at all ATP Tour events shall be paid through ATP or its designated agent at the conclusion of the tournament, unless otherwise approved by ATP. Prize money shall be distributed based on breakdowns established by ATP. ATP must approve any changes in prize money, including from year to year.
- b) ATP must receive the electronically completed ATP prize money excel spreadsheet no later than the end of the business day on the Monday following the conclusion of the tournament. The spreadsheet must be emailed to accounting@atptour.com.
- c) Tournaments are required to wire net prize money to the designated bank trust account to ensure receipt by the Wednesday following the conclusion of their respective events.

2) ATP Challenger Tour

- a) Prize money at all ATP Challenger Tour events shall be paid through ATP or its designated agent at the conclusion of the tournament, unless otherwise approved by ATP.
 - b) ATP must receive 100% of the prize money as follows:
 - New applicants – prize money must be deposited in ATP account six (6) weeks prior to the first day of the tournament.
 - Existing Events – prize money must be deposited in ATP account four (4) weeks prior to the first day of the tournament.
 - c) ATP must receive the electronically completed ATP prize money excel spreadsheet no later than the end of the business day on the Monday following the conclusion of the tournament. Spreadsheet must be emailed to accounting@atptour.com.
 - d) ATP reserves the right to seek assurances of a tournament's financial viability in the form of a letter of credit, advance payment of prize money or any other means ATP deems necessary.
- 3) Prize money shall be paid only for matches played. If a final cannot be played, then each finalist shall be paid runner-up prize money. For purposes of this section, a match is played when it is won as a result of a retirement, default, walkover or no show. (See "Exhibit K - Glossary")

Singles:

- a) A player who withdraws prior to his first match from the singles qualifying (after the Friday 10AM freeze deadline) or from the main draw singles com-

III. FINANCIAL

petition at an ATP Tour or ATP Challenger Tour event (after the start of the qualifying and prior to his first match) shall receive first round prize money (second round in the case of a Bye) if the following conditions are met:

- i) The player must be on-site at the time of the withdrawal and must be declared unfit to compete by the tournament doctor.
 - ii) Each player is limited to two (2) tournaments*, non-consecutive, in a calendar year where he may receive prize money for the on-site withdrawal.
 - * There are no limits to the number of events a player may receive prize money for the on-site withdrawal due to Covid-19 reasons as long as the events are not in back to back weeks.
 - iii) Players who have been out of competition due to long term injuries (30 days or more) and withdraw on-site become eligible for the provision to receive prize money only after they have returned to competition and competed in their first event.
 - iv) Players who have been out of competition, for any reason, 60 days or more and withdraw on-site become eligible for the provision to receive prize money only after they have returned to competition and competed in their first event.
- b) The Lucky Loser replacing a player who has withdrawn on-site shall receive qualifying prize money earned plus money earned in the main draw minus the prize money paid to the withdrawing player.

Case: A player withdraws on-site from singles before his first singles match but is still in doubles. Is he eligible for first round prize money compensation if all other conditions are met?

Decision: Yes. The player may collect the on-site prize money if he is still competing in the doubles of that tournament as long as he receives medical clearance prior to the doubles match. The doubles match cannot be on the same day as his withdrawal or on the day of his scheduled singles match.

Case: A player withdraws from singles before his first singles match and collects on site prize money. Can he play a special event or another tennis event that week?

Decision: No. Once a player withdraws he cannot continue or participate in any other event that week; whether he collects the on-site prize money compensation or not.

Case: A player withdraws on site and collects prize money. Is he allowed to do the same at the next tournament he's entered in.

Decision: No. A player is not allowed to collect prize money when withdrawing on-site at two consecutive tournaments. A player must compete in a tournament where ATP points are awarded or Davis Cup or Olympics before being allowed to collect prize money at another event.

Case: A player withdraws on site and receives prize money at an ATP Challenger Tour tournament. Subsequently, he withdraws on site and receives prize money at an ATP Tour tournament. Is the player allowed to withdraw on site and receive prize money at another ATP Challenger Tour or ATP Tour tournament?

Decision: No. Once the player has withdrawn on site and received prize money at any two, non-consecutive ATP Tour or ATP Challenger Tour tournaments, he has used his 2 tournament limit for the

III. FINANCIAL

year and is not eligible to receive prize money for any future on-site withdrawal at an ATP Tour or ATP Challenger Tour tournament in that calendar year.

Case: A player is out of competition for 30 days after retiring or withdrawing due to injury. Is he eligible to receive prize money if he withdraws on-site after being out the 30 consecutive days since his retirement/withdrawal?

Decision: No: The player is only eligible for the provision to receive prize money for an on-site withdrawal after he has returned to competition and competed in his first event.

Case: A player using a protected ranking for entry withdraws on site and collects prize money. Does this tournament count towards the total number of tournaments the player has used with his protected ranking?

Decision: Yes.

Case: If a player qualifies, accepts a special exempt or accepts a wild card and becomes a main draw player, can he receive on-site prize money if otherwise eligible?

Decision: Yes. Once he is accepted into the main draw as a qualifier, special exempt or wild card, he can receive on-site prize money compensation if otherwise eligible.

Case: A player who is not on-site withdraws after the 10 AM, Friday deadline and comes on-site to do promotional activity or to be medically examined (Challengers) in order to avoid the applicable penalties. Is he eligible for first round prize money compensation?

Decision: No. The player must be on-site at the time of the withdrawal in order to be eligible for first round prize money compensation under the rule.

Case: May a player who withdraws on-site and otherwise qualifies, decline the first round prize money?

Decision: Yes, the player may decline to accept the money and then it becomes a normal on-site withdrawal.

Case: A player is an on-site withdrawal and wants to wait to decide whether or not to accept the first round prize money if otherwise eligible. Is the player allowed to wait?

Decision: No. The player must declare his intent at the time of the on-site withdrawal.

Case: A main draw player that would have been seeded with a bye withdraws on-site after the Qualifying started but before the main draw was done. He is eligible for compensation. Does he get 1st or 2nd round PM compensation?

Decision: The player receives 1st round PM compensation. Seeding is not official until the draw is made.

Case: A main draw player withdraws late after the Qualifying has started and travels to the tournament site to perform Promotional Activities to avoid the LW fine. Is he eligible for prize money compensation?

Decision: The player is not eligible for compensation as he was not on-site when the withdrawal was done.

III. FINANCIAL

Case: During Qualifying, two players withdraw from the main draw list. One player was on-site and eligible for compensation while the other player was not on-site or otherwise ineligible to receive prize money. Neither player was seeded with a Bye. How is it decided what PM will the LL's be receiving?

Decision:

1. The lucky loser who was drawn as the number 1 LL is eligible to receive first round prize money or whatever money he earns in the main draw. He does not keep qualifying prize money.

2. The lucky loser who was drawn as number 2 LL receives qualifying money earned plus money earned in main draw, less the amount paid to the withdrawing player.

3. The same principle applies if there were more than two withdrawing players prior to the completion of the qualifying or the qualifiers being placed in the draw.

Case: A seeded main draw player with a Bye withdraws on-site after the Qualifying started, the main draw has been made and the player is eligible to collect 2nd round prize money compensation. The order of play for the first day has not been released and the next seeded player who did not receive a Bye moves into that position. How is the prize money distributed?

Decision: The seeded player moving to the bye position will receive first round prize money if he loses and first round prize money plus the difference between 2nd round and the round reached if he wins. The LL inserted in the draw receives qualifying prize money earned plus prize money earned in main draw less the 1st round prize money.

Case: Same situation as above, however the order of play for the first day has been released.

Decision: If a qualifier is drawn into the bye position he will receive first round prize money if he loses and first round prize money plus the difference between 2nd round and the round reached if he wins. The lucky loser who was drawn into the 1st round position receives qualifying prize money earned plus money earned in main draw, less the 1st round money paid to the qualifier drawn into the bye position.

Case: Two main draw players withdraw overnight after the Qualifying has finished. The Qualifiers were drawn into their respective positions in the draw. The Order of Play for the first day of main draw is released. One of the withdrawing players was seeded with a bye. The LL's are drawn into the vacant position in the draw. The second LL is drawn to replace the seeded player with the bye. How is the prize money decided if the withdrawing players have received compensation?

Decision: The LL's receive PM dependent on which player they were drawn to replace in the draw. This is a different procedure than the cases when the WD's happen before the Q is finished and the Q/LL's inserted into the draw.

Case: After the withdrawal deadline on Friday, two players/ teams withdraw from the Qualifying/Main Draw Doubles list. One player/

III. FINANCIAL

team was on-site and eligible for compensation while the other player/team was ineligible to receive prize money. How is it decided what PM the Alternates will be receiving?

Decision:

1. The highest ranked Alternate player/team who was accepted in the draw is eligible to receive first round prize money or whatever money he/they earn in the tournament.

2. The second ranked Alternate player/team who was accepted in the draw will receive the prize money earned in the tournament, less the amount paid to the withdrawing player/team. 3. The same principle applies if there were more than two withdrawing players/teams eligible for substitution by Alternates in the singles qualifying/main draw doubles.

Doubles - Prior to First Match:

A player/team accepted into the doubles main draw of an ATP Tour or ATP Challenger Tour event that withdraws prior to their first match from the main draw doubles after the doubles online on-site alternate deadline (Tour events) or the doubles on-site entry deadline (Challengers) for medical reasons shall receive first round prize money (second round in the case of a Bye) if the following conditions are met:

- a) The withdrawal was after the withdrawal deadline
- b) The withdrawing player (and his partner) must be on-site at the time of the withdrawal and the withdrawing player must be declared unfit to compete by the tournament doctor
- c) Both players used or could have used their doubles ranking for acceptance into the doubles draw.
- d) Players who have been out of competition due to long term injuries (30 days or more) and withdraw on-site become eligible for the provision to receive prize money only after they have returned to competition and competed in their first event.
- e) Players who have been out of competition, for any reason, 60 days or more and withdraw on-site become eligible for the provision to receive prize money only after they have returned to competition and competed in their first event.
- f) Each player is limited to two (2) tournaments*, non-consecutive, in a calendar year where he may receive prize money for doubles on-site withdrawal.

*There are no limits to the number of events a player may receive prize money for the on-site withdrawal due to Covid-19 reasons as long as the events are not in back to back weeks.

The alternate team replacing a team withdrawn on-site shall receive money earned in the main draw minus the prize money paid to the withdrawing player/team.

Doubles - After First Round:

Should a doubles match in an ATP Tour or ATP Challenger Tour event be uncontested* or fail to be completed, the losing team shall only receive points and prize money from the previous round unless one of the following exceptions is applicable:

III. FINANCIAL

* A team withdrawing from the first round will not receive prize money whether there is or is not an alternate/lucky loser team, except if the team qualifies for compensation as defined above.

- a) Neither player was in the singles main draw;
- b) Both players used, or could have used**, their doubles ranking for entry into the doubles draw (does not apply to wild card teams).
- c) The retiring/withdrawing player is still in the singles competition and at the time of the medical examination is declared unfit to play in the singles of that event or, if no longer involved in the singles competition of that event, is forced to withdraw from the singles or doubles*** of the next tournament in which he is entered.
 - i) For ATP Tour events if the retiring/withdrawing player was not in the singles draw of that event and is forced to withdraw from the next event in which he is accepted in the main draw (singles or doubles).
 - ii) For ATP Challenger events if the retiring/withdrawing player was not in the singles draw of that event and is forced to withdraw from the following week's event (single or doubles) after the withdrawal deadline.
- d) The retiring/withdrawing player was not involved in the singles draw of that event and:
 - i) For ATP Tour events is forced to withdraw from the next event in which he is entered (singles or doubles).
 - ii) For ATP Challenger events is forced to withdraw from the following week's event (singles or doubles***).
- e) The retiring/withdrawing player had withdrawn/retired from his singles match, which was scheduled the same day; or, if the doubles match is scheduled for a following day the player is examined by the tournament Doctor and is declared unfit for competition in the doubles event.

** Example: Player A is not in the singles draw and his doubles ranking is 20; his partner, Player B, is in the singles draw with a ranking of 15. Player B's doubles ranking is 30. The cutoff for their method of entry is 60. Using player B's doubles ranking would have kept them as a direct acceptance so they qualify for exception b) above.

*** For ATP Challenger events the withdrawal for doubles must be after the withdrawal deadline.

- 4) A player who receives a "bye" and loses in the second round shall receive second round loser's prize money.
- 5) Players affected by the entries or seedings not in accordance with ATP Rules and Regulations shall not be entitled to compensation. Such entry or seeding variances shall be resolved at the sole discretion of the Senior Vice President - Rules & Competition.
- 6) A tournament must send to ATP any prize money not paid to a player who is defaulted for improper conduct.

3.09 On-Site Prize Money

Each ATP Tour and ATP Challenger Tour tournament is required to offer and pay as part of its financial commitment the on-site prize money shown in "Exhibit J" plus hotel accommodations, unless otherwise determined by ATP. The minimum prize money for ATP Challenger Tour Tournaments is \$40,000/€36,000.

III. FINANCIAL

A. ATP Tour Tournaments

Prize money and fee payments by all ATP Tour level tournaments shall be determined as follows:

- 1) **U.S. Tournaments:** All prize money, fees etc. must be paid in USD.
- 2) **European Region Tournaments:** All prize money, fees etc. must be paid in EUR.
- 3) **All Other Tournaments:** All prize money, fees etc. must be paid in USD. Any change from USD payment must be approved by the ATP Board.

B. ATP Challenger Tour Tournaments

Prize money and fee payments by all ATP Challenger Tour tournaments shall be determined as follows:

- 1) **U.S. Challengers:** All prize money and fees must be paid in USD.
- 2) **European Region Challengers:** All prize money and fees must be paid in EUR.
- 3) **All Other ATP Challenger Tour Events:** Prize money and fees must be paid in USD.

3.11 On-Site Prize Money Adjustment

A. Exchange Rate Adjustment Rule

There will be no prize money adjustment for tournaments in the U.S. and tournaments in ATP's European Group, except for those in non-euro based countries. For all other tournaments, the on-site prize money will be increased or decreased from approved prize money levels when there are significant exchange rate changes between USD or EUR / local currency. The amount of the prize money adjustment shall be determined as follows:

- 1) As of March 31, June 30, September 30 and December 31 of each year, ATP will compare the current market exchange (ratio of local currency to USD or EUR) with the 5-year average of the same currency exchange rate for each non-U.S./ non-European group and calculate the change between the current rate and average rate as a percentage of the average rate. Prize money amounts for tournaments in countries where more than a 10% change occurs will be adjusted by one-half of the percentage change subject to a maximum adjustment of 15%.

The calculations will apply to tournaments in the following year on the dates as follows:

- a) March 31 calculation-tournaments that begin from January 1 through March 31
 - b) June 30 calculation-tournaments that begin from April 1 through June 30
 - c) September 30 calculation-tournaments that begin from July 1 through September 30
 - d) December 31 calculation-tournaments that begin from October 1 through December 31
- 2) Pepperstone ATP Rankings points will be based on approved prize money levels prior to any adjustment pursuant to this section. This section will not apply to tournaments in countries where currencies are not actively traded.

III. FINANCIAL

- 3) The Exchange Rate Adjustment rule will not apply to: new ATP Tour tournaments who have run their event for less than 5 years, existing tournaments that relocate to a country with different currency for the first 5 years in the new location, existing tournaments who previously elected to opt out of this rule and ATP Challenger Tour events. New ATP tournaments may not opt out of this rule.

3.12 Late Payment

Prize money payments not received by the due dates specified herein are subject to an initial 2% late fee, followed by a subsequent 2% late fee every 30 days.

3.13 Taxes-Notice of Withholdings

Each ATP Tour and ATP Challenger Tour tournament is required to give at least ninety (90) days notice to ATP of the percentage of the applicable player income tax deduction. No other tax deduction(s) will be permitted from the on-site prize money paid to a player. Tournaments are responsible for any additional taxes imposed. Each tournament is responsible for withholding required income taxes from each player's prize money payment and remitting such amounts to the applicable taxing authorities on a timely basis.

3.14 Withholding From Prize Money

- A. Each ATP Tour and ATP Challenger Tour tournament shall withhold from prize money only a player's applicable income tax deduction, non-member service fee, fines, advances and other ATP designated expenses.
- B. Each ATP Tour and ATP Challenger Tour tournament shall document the player income tax deduction, if any, and provide players on-site with a withholding income tax receipt.
- C. When a fine is deducted from a player's prize money paid in a currency other than the assessed currency, the exchange rate used (on the day the fine is deducted) by ATP Tour and ATP Challenger Tour tournament for the payment of prize money shall be applicable to the payment of the fine.

3.15 Prizes and Non-Cash Awards

- A. In addition to on-site prize money, each ATP Tour tournament may give to each singles and doubles winner during the on-site awards presentation one (1) non-cash award or prize plus a trophy. Non-cash awards or prizes valued over \$5,000 must be approved by the ATP CEO no later than forty-two (42) days prior to the tournament and can be offered for results in that tournament only.
- B. All non-cash awards or prizes must be the product of, or service provided by, a principal tournament sponsor.
- C. Pre-existing tournament sponsorship agreements made before 1993 for non-cash awards or prizes are exempt until the expiration of such agreements. The tournament must notify the appropriate ATP Regional Office of such non-cash awards or prizes forty-two (42) days prior to the tournament.

III. FINANCIAL

D. Tournaments may not pay travel expenses without special written permission from ATP.

3.16 Release from Financial Commitment

A. Each ATP Tour tournament is required to pay its financial commitment for each calendar year tournament.

B. No refund shall be made for any sums paid whether or not the event is actually held, unless ATP in its sole discretion determines that extraordinary circumstances exist justifying such action.

3.17 ATP Masters 1000 Tournament Financial Information

A. Each Masters 1000 tournament member is required to annually submit to the PM Committee Auditor an independently audited tournament income statement and related footnotes, along with other information as requested by the M1000 PM Committee and the PM Committee Auditor including projected tournament financials (in accordance with this rule). This income statement must be a complete and accurate determination of actual net income and net income before income taxes. In connection with the foregoing, each Masters 1000 tournament member shall provide its full cooperation to the PM Committee Auditor, who will examine and verify the accuracy of such information.

B. The following terms shall have the meanings set forth below:

“M1000 Prize Money Committee (M1000 PM Committee)” means the committee appointed by the ATP Board of Directors and authorized to act in accordance with this rule, which shall be comprised of the ATP Chairman or his designee, an Independent Member (as defined below) and an equal number of tournament and player representatives, with only one (1) tournament representative and one (1) player representative serving on such Committee being designated by the class of ATP Board Directors that appointed such representatives with the right to vote on any M1000 PM Committee matters, regardless of the number of tournament and player representatives appointed to serve on the M1000 PM Committee. The player representative and the tournament representative designated with the right to vote on M1000 PM Committee matters shall be collectively referred to herein as the **“Voting Members”**.

“PM Committee Auditor” means an independent accounting firm appointed by the M1000 PM Committee to (i) receive and evaluate each tournament member’s Submissions and projected tournament financials, (ii) perform agreed upon procedures regarding financial information included in each Submission, and (iii) prepare reports to be provided to the M1000 PM Committee and to the ATP Board of Directors in accordance with this rule summarizing the Submissions. The PM Committee Auditor will also act as advisor to the M1000 PM Committee on financial and accounting related matters and GAAP reporting issues and questions. The PM Committee Auditor will be instructed not to provide to any party, including the M1000 PM Committee, any of its members, the ATP Board of Directors, ATP or its staff, except for the Player Auditor, the ATP Chairman, CEO and CFO, individual tournament information or any information that could reasonably lead to the calculation of individual tournament information and the matching of the information to a particular tournament. The PM Committee Auditor will be required to execute and deliver to the M1000 PM Committee a state-

III. FINANCIAL

ment of confidentiality and non-disclosure prohibiting the PM Committee Auditor from making any such disclosure.

“Independent Auditor” means a highly qualified independent certified public accounting firm selected by each 1000 tournament member and approved by ATP to perform a full scope independent audit of the Tournament Income Statement and perform certain other agreed upon procedures and to provide results of such procedures to the PM Committee Auditor.

“Independent Member” means the independent member of the M1000 PM Committee appointed by the ATP Board of Directors by the affirmative vote of at least two Player Board Representatives and two Tournament Board Representatives to serve on the M1000 PM Committee for a 3-year term. The Independent Member is subject to removal at any time by the ATP Board of Directors by the affirmative vote of at least two Player Board Representatives and two Tournament Board Representatives.

“Player Auditor” means an independent certified public accountant and/or financial advisor selected by the player member(s) of the M1000 PM Committee and approved by the M1000 PM Committee in accordance with Section C below, who meets the appropriate level of expertise and experience to evaluate the accuracy of the Submissions. The Player Auditor will act as advisor to the player member(s) of M1000 PM Committee. The Player Auditor may also review items and information related to the application of the Masters 1000 Player Compensation Rule to the extent requested by the player member(s) of the M1000 PM Committee and shall provide comfort to such member(s) as to the accuracy of the Submissions to confirm the reasonableness of the PM Committee Auditor’s evaluation thereof. Player Auditor will be instructed not to provide to any party, including the M1000 PM Committee, any of its members, ATP or its staff, except for the ATP Chairman, CEO and CFO, individual tournament information or any information that could reasonably lead to the calculation of individual tournament information and the matching of the information to a particular tournament. The Player Auditor will be required to execute and deliver to the M1000 PM Committee a statement of confidentiality and non-disclosure prohibiting the Player Auditor from making any such disclosure.

“Related Party” means a person or company that has control, joint control or significant influence over the tournament or a tournament entity, either by ownership, by agreement, or by power to manage, govern or influence the tournament’s finances and/or operations. Also, a person or company is considered to be a related party to the tournament if the tournament has control, joint control or significant influence over the person or company, either by ownership, by agreement, or by power to manage, govern or influence the person or company’s finances and/or operations.

“Submission” means the prescribed, mandatory annual financial information report required to be submitted to the PM Committee Auditor by each Masters 1000 tournament member (or its Independent Auditor) hereunder, which, for the avoidance of doubt, shall include a Tournament Income Statement and further information reasonably requested by the PM Committee Auditor similar in detail to the previous Tournament Financial Review process, but also including full disclosure and arms-length fair valuation of related party transactions for both income and expenses and owner transactions. Submission must reconcile (with a schedule and explanation of any reconciling differences provided) to the audited Tournament Income Statement. Submission may also include any other information reasonably requested by the

III. FINANCIAL

M1000 PM Committee. The Submission must be completed in full as determined by the PM Committee Auditor to be considered in compliance with this rule.

“Tournament Income Statement” means the independently audited income statement which includes all revenues, costs and expenses and provides both net income and net income before income taxes related to the tournament. Such Tournament Income Statement will be reported in accordance with Generally Accepted Accounting Principles in the United States (“GAAP”) or the International Financial Reporting Standards (“IFRS”) consistently applied (depending on the applicable accounting rules in the country in which the tournament operates unless a different basis is legally mandated by the country in which the tournament operates. In such case, differences between any such other basis and GAAP or IFRS, as applicable, must be identified and resolved by such tournament member as part of its Submission). Each Tournament Income Statement shall include all revenues, costs and expenses related to the tournament’s event operations regardless of which entity affiliated with the tournament event receives, or accounts for, such revenues, costs or expenses or which jurisdiction such items are reported. All such amounts shall be reported in the tournament’s domestic reporting currency. The M1000 PM Committee has the authority to create additional rules for such reporting. Consistent with both GAAP and IFRS, tournaments will report estimated revenues, costs and expenses where final amounts are not determinable by the deadline for completing the Submission. Subsequent adjustments of these estimates to actual will be included in the Tournament Income Statement in the subsequent Submission when such final amounts are known.

C. The M1000 PM Committee will administer, implement and enforce this rule, including, but not limited to (i) determining procedures for audits for purposes of financial disclosures in accordance with the terms of this rule; (ii) determining the process of receiving financial information from tournament members and audits with respect to such information (iii) evaluating and resolving questions and issues that may arise in respect of any audit, Submission or violation of this rule; (iv) enforcing this rule pursuant to Section F below; and (v) implementing any other aspect of this rule. All actions, approvals and determinations of the M1000 PM Committee shall require a unanimous vote of the Voting Members, unless otherwise expressly provided in this rule (including as set forth in Sections B, C, E and F). The ATP Chairman shall have no right to vote on M1000 PM Committee matters; provided, however, that in the event that the Voting Members are unable to unanimously agree on the appointment of the Player Auditor, the ATP Chairman acting reasonably shall have the right to vote on whether approval of the proposed Player Auditor should be granted. If any such vote by the ATP Chairman occurs and the ATP Chairman votes against the approval of any proposed Player Auditor, then the ATP Chairman will provide a brief description of his or her reason for such decision to the M1000 PM Committee. The M1000 PM Committee will meet regularly as deemed necessary by the M1000 PM Committee to properly administer, implement and enforce this rule. The ATP Board of Directors will make reasonable and adequate funding available to enable to the M1000 PM Committee to administer, implement and enforce this rule in accordance with the terms herein.

D. Each Masters 1000 tournament member is required to provide a complete and accurate Submission annually to the PM Committee Auditor no later than 120 days following the conclusion of its tournament for such year. Each Submission must be certified

III. FINANCIAL

by the applicable tournament member as complete and accurate and in compliance with this rule in all material respects.

E. Each year, the PM Committee Auditor will perform agreed upon audit procedures (as directed by the M1000 PM Committee and as further outlined in Exhibit A) of each tournament member Submission, and report to the M1000 PM Committee any issues that it may identify as a result of these procedures for which the PM Committee Auditor is unable to resolve with the respective tournament. Once this process is complete, the PM Committee Auditor will provide the results of its procedures and the supporting audit work papers to the Player Auditor. Such information will be provided to the Player Auditor without identifying individual tournament names. The Player Auditor will undertake a review of the provided information and results. After completing this review, if the Player Auditor has any outstanding issues or questions, the Player Auditor will work with the PM Committee Auditor to resolve such issues and questions. In the event that the PM Committee Auditor and the Player Auditor are unable to resolve any such issues or questions, the PM Committee Auditor and the Player Auditor will inform the M1000 PM Committee and may jointly conduct an on-site audit at the offices of the relevant tournament or Related Party to review and evaluate the books and records of such tournament or Related Party that are reasonably necessary to resolve such issue or question; provided, that any such joint on-site audit must be conducted during regular business hours. If after any joint on-site audit, the PM Committee Auditor and the Player Auditor are still unable to resolve any such issues or questions (or in the event the PM Committee Auditor and the Player Auditor elect not to conduct an on-site audit and such issues or questions remain), the PM Committee Auditor and the Player Auditor will inform the M1000 PM Committee and the M1000 PM Committee will evaluate the information presented and make a determination on the issue(s) or question(s), and then issue a determination as to whether the unresolved issue(s) or question(s) is due to an act or omission of a tournament member. In the event that the Voting Members are unable to unanimously agree on such determination, then the Independent Member will make such determination in his or her sole discretion. If it is determined that the unresolved issue(s) or question(s) are due to an act or omission of a tournament member, then the M1000 PM Committee will determine the implications for the purpose of the prize money formula calculation and/or that tournament may be subject to a fine pursuant to Section F below.

F. Any tournament member that (i) fails to provide a Submission to the PM Committee Auditor as required under this rule (including with respect to the timing, accuracy and/or completeness thereof), (ii) submits a report or document that contains a material misstatement or omits material information, (iii) does not fully cooperate with the PM Committee Auditor and Player Auditor as required hereunder, or (iv) otherwise fails to comply with this rule, may request from the M1000 PM Committee a 10 day extension in order to comply with its submission failure. Following any such extension the tournament in each case, may be subject to a fine in a maximum amount of \$250,000. This maximum fine amount will increase by 100% for each consecutive year submission failure by a tournament. The M1000 PM Committee shall evaluate the circumstances that led to the failure of such tournament member to comply with the terms of this rule and assess an appropriate fine taking into consideration the guidelines set forth in Section G below or as otherwise provided by the ATP Board of Directors from time to time. For clarity, any such guidelines will be for guidance purposes only and the M1000 PM Committee will have the right to determine an appropriate fine in its sole discretion. In the event that the Voting Members are unable

III. FINANCIAL

to unanimously agree on a fine, the Independent Member will make such determination in his or her sole discretion taking into account the circumstances that led to the failure of the tournament member to comply with the terms of this rule. All fines assessed under this rule will be contributed to player programs as determined by the Player Board Representatives.

- G. The following guidelines are fines that may be imposed for violations of this rule (subject to the discretion of M1000 PM Committee as set forth in this rule):

Violation	Fine*
Failure to meet 120-day deadline to provide a Submission in accordance with this rule	\$20,000
Prolonged failure to meet 120-day deadline to provide a Submission in accordance with this rule (over a month late)	\$60,000
Submission contains a material misstatement or material omission of information	\$60,000 (up to a maximum of \$250,000)
Willful non-compliance with this rule (e.g., failure to provide a Submission)	Up to a maximum of \$250,000

* Specific amounts should depend on the severity of the violation and issue(s) presented.

3.18 ATP Masters 1000 Player Compensation & ATP Variable Bonus Pool

- A. On-site prize money for 2023 is the amount approved by the ATP Board for each tournament. The yearly aggregated on-site prize money for all Masters 1000 tournaments (Base Prize Money or “BPM”) will increase by 2.5% annually beginning in 2024. The 2.5% annual increase in BPM will be divided as determined by the tournaments.
- B. VBP (as defined below) is an additional annual amount that will vary with the calculation for each year and the amounts are not cumulative (don’t carry over year to year). VBP is calculated using prior year ANI, as defined below, compared to the BPM of the then current year. 50% of any excess of ANI over BPM will be contributed to VBP and paid to players based on participation and performances at the Masters 1000 and ATP Finals tournaments during the respective calendar year. The PM Committee Auditor will be responsible for making these calculations and reporting such results to the M1000 PM Committee for approval by the end of September each year. Any VBP contribution approved for payment will be shared as determined by the tournaments and will be paid to ATP for distribution to players at the end of each respective calendar year in conjunction with the payment of the ATP Fixed Bonus Pool. Allocation to players of both ATP Fixed Bonus Pool and Variable Bonus Pool as determined by the ATP Board.

III. FINANCIAL

- C. The following terms used in this Rule shall have the meanings set forth below:

Tournament Financial Information Rule for Masters 1000 Tournaments (“1000s Audit Rule”) – The ATP rule which, among other provisions, specifies the required annual independently audited reporting by each Masters 1000 tournament of its revenues, costs and expenses, net income, net income before taxes and other financial information, and specifies the audit procedures to be applied to submitted information. Definitions within the 1000s Audit Rule are incorporated herein by reference. Implementation of this Masters 1000 Player Compensation Rule will be the responsibility of the M1000 PM Committee (as defined in the 1000s Audit Rule).

Aggregated Net Income (“ANI”) - Total of annual audited net income before income taxes for each of the Masters 1000 tournaments as calculated by PM Committee Auditor and approved by the M1000 PM Committee. Level 1 data revenues and any fines assessed under the Tournament Financial Information Rule for Masters 1000 Tournaments will be excluded from each tournament’s audited net income. For combined men/women tournaments, ANI will be determined with a direct allocation method where revenues directly attributable to men or women will be allocated 100% to men or women. Remaining revenues and expenses will be allocated equally. The resulting men’s net income before income taxes will be included in ANI.

VBP - 50% of the excess of preceding year ANI over current year BPM.

3.19 ATP 500 and ATP 250 Tournament Financial Information

- A. Each 500 and 250 category tournament member is required to annually provide to the PM Committee Auditor (as defined below) a complete and accurate determination and calculation of its actual tournament Gross Revenues (as defined below), costs, expenses and net income and all other financial information and supporting documentation relating thereto, in each case, as requested by the PM Committee Auditor and in accordance with the terms of this rule. In connection with the foregoing, each 500 and 250 category tournament member shall provide its full cooperation to the PM Committee Auditor, who will examine and verify the accuracy of such information.
- B. The following terms shall have the meanings set forth below:

“Prize Money Committee (PM Committee)” means the committee appointed by the ATP Board of Directors and authorized to act in accordance with this rule, which shall be comprised of the ATP Chairman or his designee, an Independent Member (as defined below) and an equal number of tournament and player representatives, with only one (1) tournament representative and one (1) player representative serving on such PM Committee, being designated by the class of ATP Board Directors that appointed such representatives, with the right to vote on any PM Committee matters, regardless of the number of tournament and player representatives appointed to serve on the PM Committee. The player representative and the tournament representative designated with the right to vote on PM Committee matters shall be collectively referred to herein as the **“Voting Members”**.

“PM Committee Auditor” means an independent accounting firm appointed by the PM Committee to (i) receive and evaluate each tournament member’s Submissions and projected tournament financials, (ii) perform agreed upon procedures regarding

III. FINANCIAL

financial information included in each Submission, and (iii) prepare reports to be provided to the PM Committee and to the ATP Board of Directors in accordance with this rule summarizing the Submissions. The PM Committee Auditor will also act as advisor to the Committee on financial and accounting related matters and Gross Revenue, costs, expenses and net income reporting issues and questions.

“Independent Member” means the independent member of the PM Committee appointed by the ATP Board of Directors, by the affirmative vote of at least two Player Board Representatives and two Tournament Board Representatives, to serve on the PM Committee for a 3-year term. The Independent Member is subject to removal at any time by the ATP Board of Directors by the same vote required for appointment.

“Player Auditor” means an independent certified public accountant and/or financial advisor selected by the player member(s) of the PM Committee and approved by the PM Committee in accordance with Section C below, who meets the appropriate level of expertise and experience to evaluate the accuracy of the Submissions. The Player Auditor will act as advisor to the player member(s) of PM Committee. The Player Auditor may also review items and information related to the application of the ATP prize money rules to the extent requested by the player member(s) of the PM Committee and shall provide comfort to such member(s) as to the accuracy of the Submissions to confirm the reasonableness of the PM Committee Auditor’s evaluation thereof.

“Gross Revenues” means the total amount of gross revenues related to a tournament determined on the basis of the Generally Accepted Accounting Principles in the United States (**“GAAP”**) or the International Financial Reporting Standards (**“IFRS”**) (depending on the applicable accounting rules in the country in which the tournament operates), in each case, as in effect on such date of determination and consistently applied, which shall include all revenues related to the tournament’s operations regardless of which entity affiliated with the tournament receives, or accounts for, such revenues or in which jurisdiction such revenues are reported. All such revenues shall be reported in the tournament’s domestic reporting currency. For men’s and women’s combined tournaments, total Gross Revenues should be broken out by tournament and categorized by those identifiable only to the men’s tournament, those identifiable only to the women’s tournament, and all other revenues. The PM Committee has the power to create additional rules for reporting Gross Revenues. Consistent with both GAAP and IFRS, tournaments will report estimated revenues for those revenue sources where final revenue amounts are not determinable by the deadline for completing the Submission. Subsequent adjustments of these estimates to actual will be included in Gross Revenues in the subsequent Submission when such final revenue amounts are known.

“Barter” a description of each Barter transaction must be included as part of each Submission. Barter transactions as defined below for each revenue category are required to be included in Gross Revenues. Barter for this purpose is non-cash transactions (for example advertising) where value is exchanged (for example, when cars are provided as part of a car sponsor deal the value of the cars provided must be included in sponsor revenues. Another example is tickets given to a local club or charity for no consideration would not be valued or included in ticketing revenues). Barter valuations should be in accordance with GAAP or IFRS applicable to each tournament. The PM Committee will work with the PM Committee Auditor and include a comprehensive definition of barter transactions and their valuation for Gross Revenue purposes and include such comprehensive definition as part of the Submission.

III. FINANCIAL

The following Barter transactions are excluded from Gross Revenues:

- (a) Media commitments for promotional time or space that are not for resale and are used solely (i) to promote the tournament, (ii) to promote the ATP or any related event or activity of the tournament that generates Gross Revenues, (iii) to promote charitable or not for profit organizations or agencies that are unrelated to the tournament or tournament affiliates, or (iv) for public service announcements.
- (b) Any barter transaction that is both used to satisfy tournament standards and is for the direct benefit of the players. Such direct player benefits include, but are not limited to, hotel accommodations; player transportation, player food, meals and beverages; lounge for players; internet access for players; and gifting and on-court supplies for players.
- (c) De Minimus barter transactions are defined as individual transactions with valuations under \$10,000 for 250 tournaments and \$20,000 for 500 tournaments. De Minimus transactions are not required to be reported individually in the Submission as long as the total of such individual transactions is 5% or less of Gross Revenues. In the event such total exceeds 5% of Gross Revenues, tournaments must individually report the highest valued barter transactions included in the total such that the total excluding those transactions is 5% or less of Gross Revenues. A summary written description of each De Minimus transaction is required to be included in the Submission.

“Submission” means the prescribed, mandatory annual financial information report required to be submitted hereunder to the PM Committee Auditor by each 500 and 250 category tournament which, for the avoidance of doubt, shall include a determination and calculation of Gross Revenues, costs, expenses and net income, similar in detail to the prior Tournament Financial review process and any other information required or reasonably requested by the PM Committee. The Submission must be completed in full as determined by the PM Committee Auditor to be considered in compliance with this rule.

“Related Party” means a person or company that has control, joint control or significant influence over the tournament or a tournament entity, either by ownership, by agreement, or by power to manage, govern or influence the tournament’s finances and/or operations. Also, a person or company is considered to be a related party to the tournament if the tournament has control, joint control or significant influence over the person or company, either by ownership, by agreement, or by power to manage, govern or influence the person or company’s finances and/or operations.

- C. The PM Committee will administer, implement and enforce this rule, including, but not limited to (i) determining procedures for audits for purposes of financial disclosures in accordance with the terms of this rule; (ii) determining the process of receiving financial information from tournament members and audits with respect to such information; (iii) evaluating and resolving questions and issues that may arise in respect of any audit, Submission or violation of this rule; (iv) enforcing this rule pursuant to Section F below; and (v) implementing any other aspect of this rule. All actions, approvals and determinations of the PM Committee shall require a unanimous vote of the Voting Members, unless otherwise expressly provided in this rule (including as set forth in Sections B, C, E and F below). The ATP Chairman shall have no right to vote on PM Committee matters; provided, however, that in the event that the Voting Members are unable to unanimously agree on the appointment of the Player

III. FINANCIAL

Auditor, the ATP Chairman acting reasonably shall have the right to vote on whether approval of the proposed Player Auditor should be granted. If any such vote by the ATP Chairman votes against the approval of any proposed Player Auditor, then the ATP Chairman will provide a brief description of his or her reason for such decision to the PM Committee. The PM Committee will meet regularly as deemed necessary by the PM Committee to properly administer, implement and enforce this rule. The ATP Board of Directors will make reasonable and adequate funding available to enable to the PM Committee to administer, implement and enforce this rule in accordance with the terms herein.

D. Each 500 and 250 category tournament member is required to provide a complete and accurate Submission annually to the PM Committee Auditor no later than 120 days following the conclusion of its tournament for such year. Each Submission must be certified by the applicable tournament member as complete and accurate and in compliance with this rule in all material respects. The financial information included in each Submission shall be construed and prepared in accordance with GAAP or IFRS, unless a different basis is legally mandated by the country in which the tournament operates. In such case, differences between any such other basis and GAAP or IFRS, as applicable, must be identified and resolved by such tournament member as part of its Submission. Upon appointment by the PM Committee, each of the PM Committee Auditor and the Player Auditor will be instructed not to disclose any individual tournament information or documentation that it receives to any party, including the PM Committee, any of its members, the ATP Board of Directors, ATP or its staff, except for the ATP Chairman, CEO and CFO. The PM Committee Auditor and Player Auditor will be required to execute and deliver to the Committee a statement of confidentiality and non-disclosure prohibiting either the PM Committee Auditor or Player Auditor from making any such disclosure.

E. Each year, the PM Committee Auditor will perform an agreed upon desk-based procedures audit (as directed by the PM Committee) of each tournament's Gross Revenues included in the Submission and report to the PM Committee any issues that it may identify as a result of these procedures for which the PM Committee Auditor is unable to resolve with the respective tournament. Once this process is complete, the PM Committee Auditor will provide the results of its procedures and the supporting audit work papers to the Player Auditor. The Player Auditor will undertake a review of the provided information and results. After completing this review, if the Player Auditor has any outstanding issues or questions, the Player Auditor will work with the PM Committee Auditor to resolve such issues and questions. In the event that the PM Committee Auditor and the Player Auditor are unable to resolve any such issues or questions, the Committee Auditor and the Player Auditor will inform the PM Committee and may jointly conduct an on-site audit at the offices of the relevant tournament or Related Party to review and evaluate the books and records of such tournament or Related Party that are reasonably necessary to resolve such issue or question; provided, that any such joint on-site audit must be conducted during regular business hours and no more than three (3) joint on-site audits may be conducted during any consecutive twelve (12) month period. If after any joint on-site audit, the PM Committee Auditor and the Player Auditor are still unable to resolve any such issues or questions (or in the event the PM Committee Auditor and the Player Auditor elect not to conduct an on-site audit and such issues or questions remain), the PM Committee Auditor and the Player Auditor will inform the PM

III. FINANCIAL

Committee and the PM Committee will evaluate the information presented and then issue a determination as to whether the unresolved issue(s) or question(s) is due to an act or omission of a tournament member. In the event that the Voting Members are unable to unanimously agree on such determination, then the Independent Member will make such determination in his or her sole discretion. If it is determined that the unresolved issue(s) or questions(s) are due to an act or omission of a tournament member, then the revenues for that tournament could be excluded from the 500s prize money formula calculation and/or that tournament may be subject to a fine pursuant to Section F below.

F. Any tournament member that (i) fails to provide a Submission to the PM Committee Auditor as required under this rule (including with respect to the timing, accuracy and/or completeness thereof), (ii) submits a report or document that contains a material misstatement or omits material information, (iii) does not fully cooperate with the PM Committee Auditor and Player Auditor as required hereunder, or (iv) otherwise fails to comply with this rule, may request from the PM Committee a 10 day extension in order to comply with its submission failure. Following any such extension the tournament in each case, may be subject to a fine in a maximum amount of \$250,000. This maximum fine amount will increase by 100% for each consecutive year submission failure by a tournament. The PM Committee shall evaluate the circumstances that led to the failure of such tournament member to comply with the terms of this rule and assess an appropriate fine taking into consideration the guidelines set forth in Section G below or as otherwise provided by the ATP Board of Directors from time to time. For clarity, any such guidelines will be for guidance purposes only and the PM Committee will have the right to determine an appropriate fine in its sole discretion. In the event that the Voting Members are unable to unanimously agree on a fine, the Independent Member will make such determination in his or her sole discretion taking into account the circumstances that led to the failure of the tournament member to comply with the terms of this rule. All fines assessed under this rule will be contributed to player programs as determined by the Player Board Representatives.

G. The following guidelines set forth fines that may be imposed for violations of this rule (subject to the discretion of Committee as set forth in this rule):

Violation	Fine* 250/500
Failure to meet 120-day deadline to provide a Submission in accordance with this rule	\$5,000/\$10,000
Prolonged failure to meet 120-day deadline to provide a Submission in accordance with this rule (over a month late)	\$15,000/\$30,000
Submission contains a material misstatement or material omission of information	\$15,000/\$30,000 (up to a maximum of \$250,000)
Willful non-compliance with this rule (e.g., failure to provide a Submission)	Up to a maximum of \$250,000

*Specific amounts should depend on the severity of the violation and issue(s) presented.

III. FINANCIAL

3.20 ATP 500 Prize Money Formula Rule

The formula within this rule will be used to determine increases in on-site prize money for the 500 category tournaments (as this category is currently composed) for the years 2023 through 2037. In the event Net Income before taxes equals aggregated on-site prize money then this formula and the related reporting rule will be replaced with a 50/50 prize money formula similar to the Masters 1000's Prize Money Formula Rule and with the Tournament Financial Information Rule for Masters 1000 Tournaments. In the event this category is materially changed during this period, the PM Committee will determine what effect such material changes have on applying this rule for the remainder of the term. The formula will be based on a 2-year Average Growth Percentage ("AGP") in Defined Revenues ("DR") for all tournaments in the category. The PM Committee Auditor will calculate AGP and submit such calculations to the PM Committee for review and approval. Such AGP will be applied to current year category total on-site prize money as follows:

AGP up to 2.5%	On-site prize money increases by 2.5%
AGP over 2.5% to 6%	On-site prize money increases by AGP
AGP over 6%	On-site prize money increases by AGP times 1.167

The resulting overall on-site prize money increase will be allocated equally to each of the thirteen 500 tournaments, regardless of their current on-site prize money level.

Definitions:

Tournament Financial Information Rule for 500 and 250 Tournaments ("Audit Rule") - ATP rule which among other provisions defines the required annual reporting by each 500 and 250 tournament of its Gross Revenue, costs, expenses and net income and other financial information, and defines the audit procedures to be applied to submitted information. Definitions within that rule are incorporated herein by reference. Implementation of this 500s formula rule will be the responsibility of the PM Committee as defined in the Audit Rule.

Average Growth Percentage ("AGP") - AGP is the 2-year average growth in the most recent actual years DR as reported to and calculated by the PM Committee Auditor. The annual period for purposes of AGP will be the 12-month periods ending in April each year immediately following the Barcelona tournament.

Defined Revenues ("DR") - Defined revenues are the basis for the AGP calculations and include the following four broad revenue categories as long as the 2-year average of these revenues exceed 92% of average gross revenues as reported to the PM Committee Auditor:

1. Sponsorships
2. Ticketing and on-site hospitality
3. Media and television revenues
4. Government funding and/or government subsidies

Other Revenues ("OR") - OR includes all tournament revenues not otherwise included in DR.

III. FINANCIAL

Revenues within each of these categories must include all amounts earned in connection with each category. For example, if a sponsor agreement, in addition to sponsor signage and benefits, provides for on-site parking or event merchandise, total sponsor payments must be included within this category and not allocated to another revenue category. Similarly, if food and beverage and/or parking are included in a ticketing/hospitality package, the total package proceeds will be included in the ticketing/hospitality category as DR and not allocated to another revenue category.

Consistent with the Audit Rule, where applicable, Gross Revenues and DR include tournament revenues received by related parties. A person/company is considered to be a Related Party to the tournament if that person/company has control, joint control or significant influence over the tournament or a tournament entity, either via ownership, via agreement, or via power to manage/govern/influence the tournament's finances and/or operations. Also, a person/company is considered to be a Related Party to the tournament if the tournament has control, joint control or significant influence over the person/company, either via ownership, via agreement, or via power to manage/govern/influence the person/company's finances and/or operations.

If two-year average DR are less than 92% of average gross revenues, the next largest revenue category as determined by the Committee Auditor and approved by the Committee will be added to DR so that the 92% minimum is achieved.

For purposes of DR, barter transactions for each category are required to be included.

ATP payments to tournaments for rebates and prize money subsidy are not included in DR or OR. Data distribution revenues shall be included in OR and subject to reclassification within DR as provided above.

For purposes of DR, the following will also apply:

- For men's and women's combined tournaments, direct men only revenues will be included in DR at 100%. Direct women only revenues will be excluded.
- A 70% factor will be applied to combined tournaments revenues which are not directly men or women tournament revenues.
- Exchange rates to USD for formula calculation purposes and for equal prize money allocation among tournaments will be based on a 2-year average exchange rate.
- Complimentary tickets where no value is received will not be included in revenues. Complimentary tickets provided to Related Parties will be valued and included in DR.
- Taxes and fees required to be paid on tickets sales will be excluded from revenues. For this purpose, taxes and fees only include such amounts that are in effect during the year 2023.

Application of this exclusion based on 2023 determination must be consistently applied during the term.

III. FINANCIAL

Insurance proceeds which replace lost revenues will be included as revenues in the category for which the proceeds relate.

Agreed Upon Procedures as defined in the Audit Rule will only be applied to DR of the 500s tournaments. Remaining OR as reported under the Audit Rule will be subject only to overall fluctuation reviews and resulting inquiries by the PM Committee and Player Auditor necessary to understand significant changes.

3.21 250 Tournament Prize Money

On-site prize money for 2023 is the amount approved by the ATP Board for each tournament.

On site prize money for the 250 category tournaments will increase annually by 2.5% for the period 2024 through 2030. Such 2.5% annual increases in on site prize money will be calculated using the total of on-site prize money for all 250 tournaments and then divided equally among the tournaments.

IV. WORLD CHAMPIONSHIPS

4.01 Nitto ATP Finals - Singles

A. Competition Format

The tournament shall be a singles round robin format with eight (8) players. There shall be two (2) groups of four (4) players each with eight (8) seeds to be determined by the Pepperstone ATP Rankings on the Monday after the last ATP Tour tournament of the calendar year. All matches shall be the best of three (3) tie-break sets, including the final. The round robin shall determine the four (4) players for the semifinals with the format thereafter being a single elimination competition.

B. Entries

- 1) **Selection List.** The selection list for the event shall be:
 - a) The top seven (7) players in the Pepperstone ATP Rankings as of the Monday after the last ATP Tour tournament of the calendar year, followed by
 - b) Up to two (2) Grand Slam winners of that year, in order of their positions, positioned between eight (8) and twenty (20) in the Pepperstone ATP Rankings as of that Monday; followed by
 - c) Players positioned eight (8) and below in the Pepperstone ATP Rankings as of that Monday.
- 2) **Direct Acceptances.** The top eight (8) players in the selection list shall qualify for the event as direct acceptances. Participation is mandatory, and all qualified players shall be entered. All direct acceptances must be at the tournament site to attend the official pre-tournament media conference and must be available for play through the completion of the round robin competition and the knock-out competition if eligible.
- 3) **Withdrawal.** Any withdrawal, before the official pre-tournament media conference starts, shall be replaced by the next highest positioned player on the selection list, who shall be qualified as a direct acceptance.
- 4) **Alternate(s).**
 - a) The next highest positioned player on the selection list (who is not a direct acceptance at the time of the official pre-tournament media conference) shall be designated as the alternate and shall replace any player who subsequently withdraws. The alternate must appear at the official pre-tournament media conference and remain available through the start of the last scheduled round robin match.
 - b) Additional alternates may be selected by ATP to fill the draw, based on the selection list, upon terms satisfactory to ATP. Participation of such additional alternates is not mandatory.
 - c) The alternate(s) is eligible to play in the single elimination competition and to receive points and prize money if he qualifies.
 - d) If the alternate(s) does not play in the draw, then a fee shall be paid to the alternate(s). If the alternate(s) is inserted for the second or third round robin match, then he shall receive the alternate fee plus any prize money and points won. If the alternate(s) replaces a player that does not compete in his first round robin match, the alternate(s) becomes a direct acceptance and does not receive the alternate fee.

IV. WORLD CHAMPIONSHIPS

C. Failure To Participate in the Nitto ATP Finals

- 1) If a player, qualified for the Nitto ATP Finals as a direct acceptance or designated as the alternate, fails or refuses to participate in this event, except for bona fide injury or other reason which constitutes good cause, the player shall not be in good standing.
- 2) All direct acceptances and the alternate must appear at the site of the event(s) as determined by ATP and participate in the pre-tournament media conference.

Failure to appear shall result in a penalty of five percent (5%) of total ATP prize money earned during the ATP circuit year.

Please also see 1.07 H. 2) b).

D. Order of Play

Round Robin

- 1) The field shall be divided into two (2) groups of four (4) players each. The top-seeded player shall be placed in Group "A" and the second-seeded player shall be placed in Group "B". Players seeded three (3) and four (4), five (5) and six (6), and seven (7) and eight (8), shall then be drawn in pairs with the first drawn placed into Group "A."
- 2) Each player shall play every other player in his group to determine the top two (2) players in each group.
- 3) The final standings of each group shall be determined by the first of the following methods that apply:
 - a) Greatest number of wins.
 - b) Greatest number of matches played.
Comment: 2-1 won-loss record beats a 2-0 won-loss record; a 1-2 record beats a 1-0 record.
 - c) Head-to-head results if only two (2) players are tied.
 - d) If three (3) players are tied, then:
 - i) If three (3) players each have one (1) win, a player having played less than all three (3) matches is automatically eliminated and the player advancing to the single elimination competition is the winner of the match-up of the two (2) players tied with 1-2 records; or
 - ii) Highest percentage of sets won; or
 - iii) Highest percentage of games won; a player completing less than all three (3) matches is automatically eliminated and the player advancing to the single elimination competition is the winner of the match-up of the two (2) remaining players; or
 - iv) The player positions on the Pepperstone ATP Rankings as of the Monday after the last ATP Tour tournament of the calendar year.
 - v) If (i), (ii), (iii) or (iv) produce one (1) superior player (first place), or one (1) inferior player (third place), and the two (2) remaining players are tied, the tie between those two (2) players shall be broken by head-to-head record.

Comment 1: 1 player has 3 wins and the other 3 players have 1 win. Of the 3 players with 1 win, 1 player has only played in 2 matches while the other 2 players have played 3 matches. The player who has only played 2 matches is eliminated and then the 2 remaining players revert back

IV. WORLD CHAMPIONSHIPS

to head-to-head results with the winner of their match advancing to the semi-finals.

Comment 2: 1 player has 3 wins and the other 3 players have 1 win and they all have played 3 matches. The tie-break for % of sets won has 1 player with a better % than the other two. This player advances to the semi-final round.

Comment 3: 3 players have 2 wins and the other player has 0 wins. The player with 0 wins is eliminated. Of the 3 players with 2 wins, they are ordered by their % of sets won. This produces a 1, 2 & 3 order and the players finishing 1 and 2 move to the semi-final round and the player finishing 3 in % of sets won is eliminated. The player with the best % of sets won is the winner of the group.

Comment 4: 3 players have 2 wins and the other player has 0 wins. The player with 0 wins is eliminated. Of the 3 players with 2 wins, 1 player's sets won-loss is 5-2 for 71.43%; the other 2 players both have a 4-3 record in sets for 57.14%. In this case there is 1 superior player (71.43%) and the remaining 2 players are tied; it now reverts to the head to head result of the 2 remaining players with the winning player advancing as group runner-up.

Comment 5: 3 players have 2 wins and the other player has 0 wins. The player with 0 wins is eliminated. Of the 3 players with 2 wins, 2 have set won-loss records of 5-3 (62.5%) while the other player is 4-3 (57.14%). In this case we have 1 inferior player (57.14%) and he is eliminated. The remaining two players both advance to the semi-finals with the winner of their head-to-head match advancing as the group winner.

Comment 6: 3 players have 2 wins and the other player has 0 wins. The player with 0 wins is eliminated. Of the 3 players with 2 wins, all have played 3 matches and all 3 have set won-loss records of 5-4 (55.56%). In this case we move to % of games won. The % of games won breaks down like this: 44-40 for 52.38%, 45-43 for 51.14% and 44-43 for 50.57%. This produces a 1, 2 and 3 order of the group and the number 1 player in % of games won is the group winner while the player finishing 2nd in % of games won advances to the semi-finals as the group runner-up. The player with the 3rd best % of games won is eliminated.

- 4) In applying the tie-breaking procedures, a conduct default or retirement shall count as a straight-set win or loss. However, games won or lost in matches with the defaulting or retiring player shall not be counted in the application of subsection 3.d. (iii) above. A player who retires during the round robin because of illness or injury may continue in the competition if it is approved by the tournament Doctor.

Comment: This prevents a scenario where a player knows he only needs to win 1 set to qualify for the semi-finals from retiring once he has won a set.

- 5) Any player who is defaulted pursuant to the ATP Code during the round robin competition shall be defaulted from all other matches in the Championship and ATP default provisions shall apply, except for the following circumstances:
 - a) The loss of physical condition; or
 - b) Dress and Equipment.
- 6) Any player who withdraws from any round robin match after the first round shall not be eligible for the single elimination competition.

IV. WORLD CHAMPIONSHIPS

E. Single Elimination Competition

- 1) The winner of each group shall be placed in separate semi-final brackets. The runner-up of each group shall be placed in the semi-final bracket with the winner of the opposite group.
- 2) The event shall be completed with a single elimination competition for the semi-finals and final.
- 3) There shall be no playoff for the third and fourth place positions.

F. Prize Money and Points

Final standings at the end of the tournament shall determine the prize money and Pepperstone ATP Rankings points earned.

4.02 Nitto ATP Finals - Doubles

A. Competition Format

The tournament shall be a doubles round robin format with eight (8) teams. There shall be two (2) groups of four (4) teams each with eight (8) seeds to be determined by the 2023 Pepperstone ATP Doubles Team Rankings on the Monday after the last ATP Tour tournament of the calendar year. All matches shall be two (2) tie-break sets with a deciding Match Tie-break (10 point) at one (1) set all. The round robin shall determine the four (4) teams for the semi-finals with the format thereafter being a single elimination competition.

B. Entries

- 1) **Selection List.** The selection list for the event shall be:
 - a) The top 7 teams in the 2023 Pepperstone ATP Doubles Team Rankings as of the Monday after the last ATP Tour tournament of the calendar year; followed by
 - b) Up to two (2) Grand Slam winners of that year, in order of their positions, positioned between eight (8) and twenty (20) in the 2023 Pepperstone ATP Doubles Team Rankings as of that Monday; followed by
 - c) Teams positioned eight (8) and below in the 2023 Pepperstone ATP Doubles Team Rankings as of that Monday.
- 2) **Direct Acceptances.** The top eight (8) teams in the selection list shall qualify for the event as direct acceptances. Participation is mandatory, and all qualified teams shall be entered. All direct acceptances must be at the tournament site to attend the official pre-tournament media conference and must be available for play through the completion of the round robin competition and the knock-out competition if eligible.

A player who qualifies as a direct acceptance on two (2) or more teams may choose the team with which he participates. Any player with whom he does not choose to participate is ineligible to be a direct acceptance unless such player qualifies with another partner.
- 3) **Withdrawal.** All eligible teams shall be entered by ATP; however, teams may withdraw through the Monday following the last ATP Tour tournament of the year. Any withdrawal, before the official pre-tournament media conference starts, shall be replaced by the next highest positioned team on the selection list, who shall be

IV. WORLD CHAMPIONSHIPS

qualified as a direct acceptance.

4) Alternate(s).

- a) On the Monday following the last ATP Tour tournament of the year, the next highest positioned team shall be asked to confirm its status as the alternate team. Alternate team(s) may be selected by ATP to fill the draw upon terms satisfactory to ATP. Any withdrawal after the official pre-tournament media conference through the start of the last scheduled round robin match shall be filled with the alternate team(s). The alternate team must appear at the official pre-tournament media conference and remain available through the start of the last scheduled round robin match.
- b) Additional alternate teams may be selected by ATP to fill the draw, based on the selection list, upon terms satisfactory to ATP. Participation of such additional alternate teams is not mandatory.
- c) The alternate team(s) is eligible to play in the single elimination competition and to receive points and prize money if they qualify.
- d) If the alternate team(s) does not play in the draw, then a fee shall be paid to the alternate team(s). If the alternate team(s) is inserted for the second or third round robin match, then they shall receive the alternate fee plus any prize money and points won. If the alternate team(s) replaces a team that does not compete in their first round robin match, the alternate team(s) becomes a direct acceptance and does not receive the alternate fee.

C. Order of Play

Round Robin

- 1) The field shall be divided into two (2) groups of four (4) teams each. The top-seeded team shall be placed in Group "A" and the second-seeded team shall be placed in Group "B". Teams seeded three and four, five and six, and seven and eight, shall then be drawn in pairs with the first drawn placed into Group "A".
- 2) Each team shall play every other team in their group to determine the top two (2) teams in each group.
- 3) The final standings of each group shall be determined by the first of the following methods that apply:
 - a) Greatest number of wins.
 - b) Greatest number of matches played.

Comment: 2-1 won-loss record beats a 2-0 won-loss record; a 1-2 record beats a 1-0 record.
 - c) Head-to-head results if only two (2) teams are tied.
 - d) If three (3) teams are tied, then:
 - i) If three (3) teams each have one (1) win, a team having played less than all three (3) matches is automatically eliminated and the team advancing to the single elimination competition is the winner of the match-up of the two (2) teams tied with 1-2 records; or
 - ii) Highest percentage of sets won; (Winning the MTB counts as one (1) set won); or
 - iii) Highest percentage of games won. (Winning the MTB counts as one (1) game won); a team completing less than all three (3) matches is automatically eliminated and the team advancing to the single elimination competition is the winner of the match-up of the two (2) remaining teams; or
 - iv) The team positions on the 2023 Pepperstone ATP Doubles Team Rank-

IV. WORLD CHAMPIONSHIPS

ings as of the Monday after the last ATP Tour tournament of the calendar year.

- v) If (i), (ii), (iii) or (iv) produce one (1) superior team (first place), or one (1) inferior team (third place), and the two (2) remaining teams are tied, the tie between those two (2) teams shall be broken by head-to-head record

Comment 1: 1 team has 3 wins and the other 3 teams have 1 win. Of the 3 teams with 1 win, 1 team has only played in 2 matches while the other 2 teams have played 3 matches. The team who has only played 2 matches is eliminated and then the 2 remaining teams revert back to head-to-head results with the winner of their match advancing to the semi-finals.

Comment 2: 1 team has 3 wins and the other 3 teams have 1 win and they all have played 3 matches. The tie-break for % of sets won has 1 team with a better % than the other two. This team advances to the semi-final round.

Comment 3: 3 teams have 2 wins and the other team has 0 wins. The team with 0 wins is eliminated. Of the 3 teams with 2 wins, they are ordered by their % of sets won. This produces a 1, 2 & 3 order and the teams finishing 1 and 2 move to the semi-final round and the team finishing 3 in % of sets won is eliminated. The team with the best % of sets won is the winner of the group.

Comment 4: 3 teams have 2 wins and the other team has 0 wins. The team with 0 wins is eliminated. Of the 3 teams with 2 wins, 1 team's sets won-loss is 5-2 for 71.43%; the other 2 teams both have a 4-3 record in sets for 57.14%. In this case there is 1 superior team (71.43%) and the remaining 2 teams are tied; it now reverts to the head to head result of the 2 remaining teams with the winning team advancing as group runner-up.

Comment 5: 3 teams have 2 wins and the other team has 0 wins. The team with 0 wins is eliminated. Of the 3 teams with 2 wins, 2 have set won-loss records of 5-3 (62.5%) while the other team is 4-3 (57.14%). In this case we have 1 inferior team (57.14%) and this team is eliminated. The remaining two teams both advance to the semi-finals with the winner of their head-to-head match advancing as the group winner.

Comment 6: 3 teams have 2 wins and the other team has 0 wins. The team with 0 wins is eliminated. Of the 3 teams with 2 wins, all have played 3 matches and all 3 have set won-loss records of 5-4 (55.56%). In this case we move to % of games won. The % of games won breaks down like this: 44-40 for 52.38%, 45-43 for 51.14% and 44-43 for 50.57%. This produces a 1, 2 and 3 order of the group and the number 1 team in % of games won is the group winner while the team finishing 2nd in % of games won advances to the semi-finals as the group runner-up. The team with the 3rd best % of games won is eliminated.

- 4) In applying the tie-breaking procedures, a conduct default or retirement shall count as a straight-set win or loss. However, games won or lost in matches with the defaulting or retiring team shall not be counted in the application of subsection 3.d. (iii) above. A team who retires during the round robin because of illness or injury may continue in the competition if it is approved by the tournament Doctor.

Comment: this prevents a scenario where a team knows he only needs to win 1 set to qualify for the semi-finals from retiring once he has won a set.

- 5) Any team who is defaulted pursuant to ATP Code during the round robin competition shall be defaulted from all other matches in the Championship and ATP default provisions shall apply, except for the following circumstances:

IV. WORLD CHAMPIONSHIPS

- a) The loss of physical condition; or
b) Dress and Equipment.
- 6) Any team who withdraws from any round robin match after the first round shall not be eligible for the single elimination competition.

D. Single Elimination Competition

- 1) The winner of each group shall be placed in separate semi-final brackets. The runner-up of each group shall be placed in the semi-final bracket with the winner of the opposite group.
- 2) The event shall be completed with a single elimination competition for the semi-finals and final.
- 3) There shall be no playoff for the third and fourth-place positions.

E. Prize Money and Points

Final standings at the end of the tournament shall determine the prize-money and Pepperstone ATP Doubles Rankings points earned.

4.03 United Cup

The United Cup is an annual country vs country mixed team competition. Eighteen (18) countries will participate, with a minimum of three ATP and three WTA players per country.

A. Round Robin Competition

- 1) The United Cup is a competition for eighteen (18) teams, each team composed of a minimum of three (3) ATP and three (3) WTA players and a maximum of four (4) ATP/WTA players from the same country. The team criteria shall be:
- a) The three (3) highest ranked singles ATP/WTA players; then
b) Teams may include a 4th ATP and WTA player, whose entry will be accepted based on being the highest of singles ranking (up to maximum 500) or doubles ranking (up to maximum 250).
c) A junior player, meeting the criteria stated below, may be included as a country's 4th respective Tour player.
- The junior player must,
- i) Be born in 2004 or later, and
ii) Be ranked 500 or better in Singles rankings as of the Rankings Deadline, or
iii) Be ranked 50 or better in the ITF Junior World Rankings as of the Rankings Deadline
iv) Have entered the event

Only one (1) junior player may be included per gender, per team (maximum 1 male, 1 female)

- d) All players except an approved junior player must have an ATP Ranking (singles or doubles).
- 2) A player's nationality as of the entry date shall be used to determine team entry. All player nationality determinations are subject to ATP approval.
- 3) The competition shall be a Round Robin format with six (6) groups of three (3) teams each. All singles matches shall be the best of three (3) tie-break sets. All

IV. WORLD CHAMPIONSHIPS

mixed doubles matches shall be two (2) tie-break sets with a deciding Match Tie-Break (10 point) at one (1) set all.

- 4) Each team shall play each other in its group to determine the top team in each group. Group winners will advance to the City Final match, playing off for one of 3 guaranteed Semi-Final spots against the winner of the other group from that host city. The remaining Semi Final spot will be awarded to the best performing team throughout the entire competition, from the 3 City Final runners-up.

B. Player Nationality / Change of Nationality

A player's nationality as of the entry date shall be used to determine team entry. All player nationality determinations are subject to ATP/WTA approval.

- 1) **Nationality.** A player's nationality on the date of that country's acceptance to the United Cup shall determine the player's eligibility to compete for that country.
- 2) **Change of Nationality.**
 - a) A player may only represent one (1) country in the United Cup during their career, unless
 - a. The player change their nationality in the ATP/WTA database AND
 - b. Any of the following apply:
 - i. The player competed under such nationality in the BJK Cup, Davis Cup, or Olympic Tennis Event, or
 - ii. The player competed under such nationality in professional tennis tournaments during the Tour Year immediately preceding the United Cup,
 - iii. ATP/WTA determines the full circumstances of the player's situation demonstrate the player has a sufficient, genuine connection to the nation that the player wishes to represent, or
 - iv. In exceptional circumstances as determined by ATP/WTA.
 - b) All requests to change a player's nationality are subject to ATP/WTA approval.

C. Teams Qualifications

- 1) **Entry.** The teams shall be selected and entered in the following manner:
 - a) A team shall be entered based upon the ATP/WTA Ranking (singles) of the country's Number 1 singles player.
 - b) All players must confirm in writing they will be playing the event to confirm entry.
 - c) There shall be one (1) wild card allocated for the host country in case their team does not otherwise qualify. If no Wild Card is necessary, then that position shall revert to an additional Direct Acceptance.

If the Wild Card is needed for the host country, then the Wild Card team will be placed randomly into one of the six (6) groups.

2) **Entry – Deadline and Acceptance**

- a) **Entry deadline.** Tuesday 8 November 2022. The top fifteen (15) Direct Acceptance countries that qualify using the 7 November 2022 ATP/WTA Ranking must confirm their acceptance to the competition by this deadline.

IV. WORLD CHAMPIONSHIPS

- 3) **Qualification.** In order to qualify for the competition, a team that has accepted entry must comply with the following requirements:

At this entry deadline, the Top 6 WTA qualified countries, 5 of the 6 ATP qualified countries and Top 5 combined entry countries will be admitted to the competition, with the final two remaining entrants to be admitted to the competition on Monday 21 November 2022 based on the 21 November 2022 rankings.

Players must enter the event to be eligible (i.e., no automatic entries)

- a) The team is composed of the two (2) highest positioned and eligible players based on the ATP/WTA Ranking (Singles) as of 7 November 2022.
- b) A third ATP/WTA singles ranked player must be named by the deadline, 8 November 2022, and must be on-site for the competition.
- c) A fourth player may be named, if eligible, at the time of the deadline. The No. 4 players will be chosen based on their highest ATP/WTA Ranking (Singles or Doubles) as of 7 November 2022.
- d) In the case of illness, injury or unforeseen circumstances, and the team number falls below three (3) members, the Supervisor and the Steering Committee may allow the team Captain to nominate a substitute player during the competition, although the team may continue with only two (2) members per gender.
- e) The Steering Committee may use discretion if a team includes a Top 20 ATP/WTA player and does not wholly meet the qualification criteria pertaining to the ATP or WTA third and fourth player.

4) **Ties – Team Entry**

The 6 Highest ranked ATP and 6 highest ranked WTA players determine the first 12 teams. If players of the same nationality qualify a team in both ATP and WTA or within either ATP or WTA Top 6, the next ranked players outside of the Top 6 will qualify their country until 12 teams are qualified (6 from ATP top ranked players and 6 from WTA top ranked players).

- a) For the top singles spot to determine team entry, entry is based on the ATP/WTA Ranking (Singles):
 - i) If tied a current singles ranking beats a Protected Ranking/Special Ranking.
 - ii) If tied between two current rankings or two Protected Rankings/Special Rankings, the ranking of the highest number 2 players will break the tie. If still tied, we move on to the number 3 player, etc.

The final 6 teams will be determined by the highest combined ranking of the Top ATP and Top WTA ranked players who have not yet qualified their country. Where a combined ranking is equal between two teams, the team with the highest ranked singles player (ATP or WTA) will take priority. If still equal, the team with the highest ranked second singles player will take priority.

5) **Ties – Individual Entry**

- a) For spots 1-3 where entry is based on the ATP/WTA Ranking (Singles).
 - i) If tied.
 - A current ranking beats a Protected Ranking/Special Ranking.
 - If still tied, the most total points from the Grand Slams, mandatory ATP Tour Masters 1000, WTA 1000 mandatory and WTA 1000 tournaments and Nitto ATP Finals main draws, and if still tied, then,

IV. WORLD CHAMPIONSHIPS

- If still tied, the fewest events played, counting all missed Grand Slams, ATP Tour Masters 1000 tournaments they could have played (as described under A. above) as if played, and if still tied, then,
 - If still tied, coin toss
- b) For spot 4 where entry is based on the best-of ATP/WTA Ranking (Singles or Doubles).**
- i) If tied.**
- If best-of ranking is the same, the player with the highest ATP/WTA Singles Ranking wins the tie. Ties between singles rankings are broken as per point a) above.
 - If both ATP/WTA Doubles Rankings are the same, the player with the highest ATP/WTA Ranking (Singles) wins the tie. Ties between doubles rankings are broken as per the ATP/WTA tie breaking rules.
 - A current ranking beats a Protected Ranking/Special Ranking.
 - If still tied, coin toss
- 6) Withdrawal of entry**
- a) The deadline for withdrawal of entry for a player / team shall be as follows:**
- i) For those players/teams confirming entry on the entry deadline, any withdrawal after 5:00pm Eastern US on Tuesday, 8 November 2022 will be considered as a Late Withdrawal.**
- ii) WTA - A player's withdrawal from United Cup is subject to all applicable withdrawal requirements and penalties in Section IV of the WTA Rules.**
- b) Violation of this Section shall be penalized consistent with the Player Code of Conduct. Late Withdrawal Fines shall apply and be based upon the player's ranking at the date of acceptance. Any player withdrawing after accepting entry shall not be permitted to participate in any other event, including exhibitions, during the United Cup Competition.**
- c) Players have the right to an Appeal of the Late Withdrawal Fine which must be submitted to the ATP Appeals Tribunal/WTA, which consideration is limited to the fine only.**
- 7) Late Withdrawals / Substitutions**
- a) Number 1 player withdraws after the deadline, 8 November 2022.**
- i) The team remains in the competition as long as there is a minimum of three (3) ATP/WTA Ranked players on the team, two of which must have an ATP/WTA Ranking (Singles), unless otherwise approved by ATP/WTA or, an Alternate is inserted as approved by ATP/WTA. This can include a replacement player. The team must also have at least 1 ATP or WTA member of the team ranked 250 or better in singles to remain in the competition. Number 1 and 2 players to be reclassified if required.**
- ii) The next highest ranked singles player from that country may be added to the team, unless otherwise approved by ATP/WTA. Non-entered substitute/alternate players may only be considered if the team does not have a minimum of 3 entered players meeting the criteria.**
- b) A top 2 singles player withdraws prior to 10:00 am local time in Sydney, the day prior to the start of the competition.**
- i) The next highest singles ranked player from that country may be added to the team, unless otherwise approved by the ATP/WTA. That player may either be a player not already accepted to a Week 1 event, or a player who by approval of ATP/WTA may be able to withdraw from qualifying of a week 1, prior to the start of the qualifying event without penalty.**
- c) One of the positions (players 3-4) withdraws prior to 10:00 am local time in**

IV. WORLD CHAMPIONSHIPS

- Sydney, the day prior to the start of competition.
- i) The next player from that country with the highest ATP/WTA Ranking (Singles or Doubles) may be added to the team. That player may either be a player not already accepted to a Week 1 event, or a player who by approval of ATP/WTA may be able to withdraw from ATP/WTA Tour qualifying or Challenger Main Draw and Qualifying of a week 1, prior to the start of the qualifying event without penalty.**
- d) All substitutions are subject to ATP/WTA approval.**
- e) If through the withdrawal of the number 1 player or the numbers 1 and 2 players between the deadline (8 November 2022) and 10:00 am local time in Sydney, the day prior to the start of competition, a team may be withdrawn and replaced by an alternate team if they do not have at least one member of the team ranked 250 or better in singles.**
- 8) Alternate Team Selection**
- a) The Alternate Team will be the first team out of the final selection.**
- b) If needed, the individual players may be granted a release from any other ATP/WTA Tour Qualifying event they are entered in during the period of the United Cup Competition, pending ATP/WTA approval, or from any ATP Challenger Tour event.**
- c) The Alternate Team may be selected for participation until 10:00 am local time in Sydney, the day prior to the start of competition.**
- 9) Withdrawals after Start of the Competition**
- a) Any team that through withdrawals of team members has only two (2) players remaining may continue in the competition as long as both players have, at a minimum, one player with an ATP/WTA Ranking and one player with an ATP/WTA Doubles Ranking, unless approved by ATP/WTA. These two players must play singles and be available for the mixed doubles.**
- b) If a team has only one (1) eligible ATP or WTA player, loses by Walkover and no matches will be played, unless if approved by the Steering Committee the team may remain in competition and the matches for the missing player are lost by Walkover. No points are awarded for Walkovers.**
- c) A team may add an alternate player after the competition has begun as long as the player is not violating ATP/WTA rules for "No Play after Withdrawal" or "One Tournament per Week", or as approved by ATP/WTA. In no case may a player compete in two events offering ATP/WTA Ranking points which are held in the same ranking week.**
- 10) Seeding**
- Seeding for the event will be based off the combined regular ranking (no protected ranking/special ranking) of the top ATP and top WTA ranked player regardless of their qualification into the event. As per the entry order priority rule, where a combined ranking is equal between two teams, the team with the highest ranked singles player (ATP or WTA) will become the higher seed. If still equal, the team with the highest ranked second singles player will be the higher seed.
- D. Competition Format**
- Host Cities**
- Sydney, Brisbane and Perth will host Countries for the Group Stages, and Sydney will host the Semi Finals and Final.

IV. WORLD CHAMPIONSHIPS

At the Official Draw, Sydney, Brisbane and Perth will be drawn as host of one of 3 combinations of seeds –

- #1 (Group A) and #6 (Group F)
- #2 (Group B) and #5 (Group E)
- #3 (Group C) and #4 (Group D)

For 2023 Australia will compete in Sydney, so the Groups competing in Sydney will be determined by where Australia is drawn.

1) Round Robin – The Groups

The Draw-Teams 1-18

- The official draw for the placement of teams 1-18 shall take place, on Thursday 10 November 2022, following the 8 November 2022 deadline.
- The teams shall be positioned from 1 to 18 in accordance with the best combined ATP/WTA Ranking (Singles) as of 7 November 2022, of the number 1 players of each team accepted at the 8 November 2022 deadline. Two team positions 1 ATP Qualified position and 1 Combined position will be reserved. The final two remaining entrants to be admitted to the competition on Monday 21 November based on the November 21 rankings.
- The top six (6) teams shall be placed in separate groups.
- The next six (6) teams in rank order (7-12) shall be drawn at random into the six (6) groups.
- The next six (6) teams (13-18) shall be drawn at random for each of the six (6) groups.
- The final two (2) teams selected at the second deadline shall be drawn at random for each of the two (2) incomplete groups.

Groups will be assigned as follows:

Group A

#1 seeded country, plus one randomly selected team from each of the following bands –

- Seeded countries 7 – 12
- Seeded countries 13 – 18 inclusive of the final 2 countries to be included in the competition

Group B

#2 seeded country, plus one randomly selected team from each of the following bands –

- Seeded countries 7 – 12
- Seeded countries 13 – 18 inclusive of the final 2 countries to be included in the competition

Group C

#3 seeded country, plus one randomly selected team from each of the following bands –

- Seeded countries 7 – 12
- Seeded countries 13 – 18 inclusive of the final 2 countries to be included in the competition

IV. WORLD CHAMPIONSHIPS

Group D

#4 seeded country, plus one randomly selected team from each of the following bands –

- Seeded countries 7 – 12
- Seeded countries 13 – 18 inclusive of the final 2 countries to be included in the competition

Group E

#5 seeded country, plus one randomly selected team from each of the following bands –

- Seeded countries 7 – 12
- Seeded countries 13 – 18 inclusive of the final 2 countries to be included in the competition

Group F

#6 seeded country, plus one randomly selected team from each of the following bands –

- Seeded countries 7 – 12
- Seeded countries 13 – 18 inclusive of the final 2 countries to be included in the competition

2) Daily Order of Play - The Tie

- A tie consists of four (4) singles matches and one (1) mixed doubles match.
- Each team Captain shall submit to the ATP/WTA Supervisor, in writing, the name of the four (4) singles players and the mixed doubles team selected to compete in the Tie. The singles players shall be the top two (2) ranked ATP/WTA players (including protected ranking/special ranking) as of the date of the entry deadline unless there is a medically supported substitution.
- The deadline to submit the names of the competing players (singles/doubles) is 3:00pm local time, the day prior to the scheduled Tie.
- For each Tie, the highest-positioned (hereafter, number ones) singles players named from each team shall compete against each other and the second positioned (hereafter, number twos) singles players named from each team shall compete against each other. The order of positions in each team shall be based upon the most recent ATP/WTA Ranking as of the Monday prior to the start of the competition. The order of matches shall be as follows played over two (2) days unless otherwise decided by the Steering Committee:
 - Number 2 ATP/WTA Singles followed by
 - Number 1 ATP/WTA Singles followed by
 - Number 1 ATP/WTA Singles followed by
 - Number 2 ATP/WTA Singles followed by
 - Mixed Doubles
- Upon the completion of the mixed doubles match, the winner of the tie shall be the team that wins at least three (3) of the five (5) matches.
- The mixed doubles match must be played regardless of the results of the two singles matches. *

*For the Semi-Finals & Finals, if the tie is decided following the singles matches, the mixed doubles match will not be played (unless mutually agreed by both Countries), and the money will be split evenly amongst the members of both teams.

IV. WORLD CHAMPIONSHIPS

3) Format and Competition

a) Groups

There will be six Groups comprising of three countries in each group. Each city will host two groups (six countries) for the Group stages, which will consist of round robin ties where each country will play both other countries in their group.

Group winners will advance to the City Final match, playing off for one of 3 guaranteed Semi-Final spots against the winner of the other group from that host city. The remaining Semi Final spot will be awarded to the best performing team throughout the entire competition, from the 3 City Final runners-up.

4) Determination of Group Winners

a) Number of ties won

b) Number of Ties Played

Comment: 2-1 win-loss beats 2-0 win-loss. A 1-2 win-loss beats a 1-1 or 1-0 record. A team winning by walkover shall have the tie count in its results as a tie played. The team causing the walkover shall not have the tie counted as a tie played.

c) In a tie between three (3) teams, the following shall apply:

i) If three (3) teams have the same number of wins, then the team having played fewer total matches (singles & mixed doubles) will be eliminated and the winner of the head-to-head matchup between the two remaining teams advance, if still tied then,

Comment: 11-1 win-loss beats 11-0 win-loss. A 5-7 win-loss beats 5-0 record

ii) The team with the most match wins (singles & doubles), if still tied then,

iii) The team with the highest percentage of matches won, if still tied then,

iv) The team that has the highest percentage of sets won, if still tied then,

v) The team with the highest percentage of games won,

d) If ii), iii), iv) or v) produce one superior team (first place), then the tie is broken, or

e) If ii), iii), iv) or v) produce one inferior team then that team is eliminated and the winner of the match between the two (2) remaining teams is the winner of the group.

Notes: In all tie-break situations, the following shall apply.

- Unplayed matches shall be scored as completed for purposes of matches played.
- Defaulted and retired singles or doubles matches shall be scored as completed for purposes of matches played and will count as a straight set win or loss. However, games won or lost in matches with defaulting or retiring player shall not be counted for percentage of games won.
- Teams advancing from a tie via a team walkover (i.e. no alternate) will count as a tie won but this does not count towards total matches won, percentage of sets or percentage of games won.
- Any team that withdraws from any round robin tie after the first-round robin tie shall not be eligible for the City Finals.
- The Match Tie-Break (doubles) counts as a set won and for games won counts as 1-0

5) City Finals

Group winners will advance to the City Final match, playing off for one of 3 guaranteed Semi-Final spots against the winner of the other group from that host

IV. WORLD CHAMPIONSHIPS

city. The remaining Semi Final spot will be awarded to the best performing team throughout the entire competition, from the 3 City Final runners-up.

6) Determination of Best Runner up from City Finals

a) Number of ties won

b) Number of Ties Played

Comment: 2-1 win-loss beats 2-0 win-loss. A 1-2 win-loss beats a 1-1 or 1-0 record. A team winning by walkover shall have the tie count in its results as a tie played. The team causing the walkover shall not have the tie counted as a tie played.

c) In a tie between three (3) teams, the following shall apply:

i) If City Finals Runners UP have the same number of wins, then the team having played fewer total matches (singles & mixed doubles) will be eliminated and, if still tied then,

Comment: 11-1 win-loss beats 11-0 win-loss. A 5-7 win-loss beats 5-0 record

ii) The team with the most match wins (singles & doubles), if still tied then,

iii) The team with the highest percentage of matches won, if still tied then,

iv) The team that has the highest percentage of sets won, if still tied then,

v) The team with the highest percentage of games won,

d) If ii), iii), iv) or v) produce one superior team (first place), then the tie is broken, or

Notes: In all tie-break situations, the following shall apply.

- Unplayed matches shall be scored as completed for purposes of matches played.
- Defaulted and retired singles or doubles matches shall be scored as completed for purposes of matches played and will count as a straight set win or loss. However, games won or lost in matches with defaulting or retiring player shall not be counted for percentage of games won.
- Teams advancing from a tie via a team walkover (i.e. no alternate) will count as a tie won but this does not count towards total matches won, percentage of sets or percentage of games won.
- Any team that withdraws from the City Finals shall not be eligible for Semi Finals.
- The Match Tie-Break (doubles) counts as a set won and for games won counts as 1-0

6) Finals in Sydney

a) Semi-Finals

The three winners of the City Finals will qualify for the Semi-Finals in Sydney. The remaining Semi-Final spot will be awarded to the best performing team throughout the entire competition, from the 3 losing teams out of the City Finals.

• **S/Final 1** – WINNER of Groups B/E v WINNER Groups C/D

• **S/Final 2** – WINNER Groups A/F v Best Runner Up from Group Winners Matches*

*Should the best Runner Up from the City Finals Matches result in a City Final rematch in the Semi Finals, the match-ups will swap to award the highest seeded country with the best runner up.

b) The Champion Team shall be decided by the result of a straight knock-out competition.

IV. WORLD CHAMPIONSHIPS

E. Protected Ranking/Special Ranking*

The following applies to any player with a Protected Ranking ("PR")/Special Ranking that has been used in any manner during the competition or to qualify a country for entry.

- 1) The PR must be valid at the entry deadline in which the player/country qualifies.
- 2) If valid at the entry deadline for qualification it shall remain valid throughout the competition.
- 3) Can be used for team entry.
- 4) Will count for position in the singles lineup.
- 5) Will count for Ranking points.
- 6) Will not count for team seeding.
- 7) **For WTA players** - Will count as Special Ranking used for the player(s).
- 8) **For ATP players** - Will not count as Protected Ranking used for the player(s).
- 9) May only be used at one (1) United Cup event.

F. Schedule of Play

The following is the schedule of play unless otherwise determined by the Tournament Committee and Supervisor:

- 1) The eighteen (18) teams shall play Round Robin matches over the first six days to determine the six (6) winners of the Round Robin groups qualifying for the City Finals.
- 2) Following the draw, the daily ties (country v country) for the round robin sessions will be scheduled and announced.
- 3) All players and Captains must be available for play on the first day of the event.
- 4) Once the Captain has named the four (4) players competing in the singles, the pairings for the Tie shall be made automatic as determined by the ATP/WTA Ranking (including Protected Ranking/Special Ranking) on the Monday prior to the start of the competition.
- 5) Protected Ranking/Special Ranking (singles) will be used for a player's position on the team but cannot be used for team seeding.
- 6) The City Finals final shall be held on the 7th day (Wednesday) of the Tournament.
- 7) A travel day will take place on the 8th day (Thursday) of the Tournament
- 8) The Semi-Finals will be held on the 9th and 10th day of the tournament – each Tie split over two days.
- 9) The Final will be held on the 11th day of the tournament.
- 10) The ATP/WTA Supervisors reserve the right to change the schedule of play, alter starting times and make other changes deemed necessary for the smooth running of the competition.

IV. WORLD CHAMPIONSHIPS

G. Team Captain / Team Coaches

1) Designation of Captain

- a) The number one player on each team (the highest ATP/WTA singles ranked player) is by default the Team Captain, however each team can elect another player or person as Team Captain, provided such person is of the same nationality. The No 1 player has the overall authority on the position of team captain. If the No 1 player decides to appoint a team captain instead of fulfilling the role, the chosen person must be either an ATP / WTA player, former player or coach. Exceptions to this are subject to approval by the Event Steering Committee. The Team Captain must be confirmed and submitted to the ATP/WTA no later than December 1.

The Team Captain is responsible for attending all meetings, submitting the team's line up and acting as the official representative for the team.

Coaching is allowed, and the Team Captain will have the option to sit on the court throughout matches.

- b) The Captain must be communicated to ATP/WTA no later than December 1, 2022.
- c) In the event the Captain is not on-site or not available, the number one (1) player shall assume the role of Captain or designate a non-playing team member as Captain.
- d) The Captain must be on-site for the duration of that team's participation in the competition. The Captain shall be subject to all provisions of the Player Code of Conduct, including those pertaining to Dress and Equipment.

2) Duties of the Captain. The duties of the Captain are as follows:

- a) Designate the team's lineup, after consultation with the team members;
- b) Act as official representative for their respective team;
- c) Attend all team meetings; and
- d) The designated Captain may sit on court during the match and may coach during changeovers, set-breaks and during play as long as it does not interrupt play.
- e) The Captain may speak to the Chair Umpire, however only the Player may initiate Challenges to line calls.

3) Individual Coaches*

- a) Each player may have his personal coach be the designated coach for his matches.

*Individual coaches with multiple players can coach their players even if they are competing for different countries. If a coach has one player on each competing team, then the coach may only be on court for one country in that tie. This does not apply if the individual coach is also the Captain of a team. A Captain may only sit on court and coach for the team he is captaining.

4) Duties of the Coach. The duties of the coach are as follows:

- a) During each match the player involved may use his personal coach to assist him during the match.
- b) The coach will sit in the designated area assigned for the coach of that match.
- c) The coach may sit on court during the match and may coach during changeovers, set-breaks and during play as long as it does not interrupt play.
- d) Official team members/coaches may also communicate with the player during changeovers and set-breaks.

IV. WORLD CHAMPIONSHIPS

- e) All team members, Captain and coaches, when courtside, must sit in the area designated for the teams participating in that Tie.
- f) The coach must adhere to the ATP Code of Conduct, including logo restrictions on attire.

5) Player Designations

- a) Each team Captain shall submit to the ATP/WTA Supervisor, in writing, the name of the four (4) singles players and the mixed doubles team selected to compete in the Tie. The singles players shall be the top two (2) ATP/WTA ranked players (including protected ranking/special ranking) as of the date of the entry deadline, unless there is a medically supported substitution, or otherwise approved by the Supervisor.
- b) The four (4) singles players, named from each country for the Tie, shall be designated as players 1 and player 2 (ATP/WTA), based upon the most recent ATP/WTA Ranking (including Protected Ranking/Special Ranking) as of the Monday prior to the start of the competition. Change may be allowed for medical conditions or for unforeseen circumstances approved by the ATP/WTA Supervisor.
- c) The team Captains must give in writing the names of the four (4) singles players and the mixed doubles team to the Supervisor no later than 3:00pm on the day prior to the scheduled Tie. The mixed doubles team may be chosen from any ATP/WTA players named to the team.
For the Tournament Final, the team Captain must give in writing the names of the four (4) singles players and the mixed doubles team to the Supervisor within fifteen minutes after the completion of the second tie determining the teams for the upcoming Final.
- d) Following the conclusion of the fourth singles match, any change in the mixed doubles team must be communicated to the ATP/WTA Supervisor, in writing, within 10 minutes of the conclusion of the fourth singles match. The Supervisors shall notify the opposing Captain and all other relevant staff once both Captains have submitted their doubles teams.
- e) There shall be a maximum of twenty-five (25) minutes between the end of the last singles match and the start of the mixed doubles match if one or more of the doubles players competed in the last singles match. If none of the players designated for the mixed doubles has competed in the last singles match, the mixed doubles shall be scheduled as “followed by” with the exact time determined by the Supervisor. Fifteen minutes is recommended following the conclusion of the last singles match, however mixed doubles players who competed in the last singles match can elect to start after fifteen (15) minutes or after twenty-five (25) minutes.
- f) The Captain must name the mixed doubles team one hour before the start of the day's play if his team has no singles matches on that day (rain or other cause of delay).
- g) The team Captain may, whenever necessary, replace a singles player in the case of illness, injury or unforeseen circumstances approved by the ATP/WTA Supervisor.
 - i) After the Order of Play is released and up to the start of the first match.
 - Order of Play will be adjusted based upon the new team order, if necessary.
 - ii) After the start of the first singles match.
 - A player who is substituted for a player named to the second match cannot change the team order. For example, a player substituted for

IV. WORLD CHAMPIONSHIPS

the number 2 player cannot have a better ranking than the player competing at number 1 for that team.

- iii) A player who withdraws from the singles shall be eligible for mixed doubles on that same day.
- iv) In the event of match changes, the Supervisor may allow reasonable time adjustments in the schedule.
- h) In the event of a conduct default, the Supervisor may decide to remove the offending player(s) for the remainder of the tie or event.

H. Medical

1) Tournament Doctor

- a) An official Tournament Doctor is required to be present at all times during play and a reasonable time before play begins.
- b) The tournament doctor shall be available for court calls as necessary.

2) ATP Physiotherapist/WTA Primary Health Care Provider (PHCP)

- a) Each venue will have an ATP Physiotherapist(s)/WTA PHCP(s) assigned to the event.
- b) Only the ATP Physiotherapist/WTA PHCP will be allowed on court during the match.

I. Code of Conduct

1) Players. All players are subject to the ATP/WTA Code of Conduct.

a) Dress and Equipment.

- i) All team members must dress in similar attire that identifies them with the country they are representing.
- ii) Team attire must be submitted to and approved by ATP/WTA in advance of the event.

2) Team Captain / Coaches. All Team Captains and Coaches are subject to the provisions specified in the ATP/WTA Code of Conduct regarding Dress and Equipment and conduct on-site during the event.

During matches, official functions and media appearances, all Team Captains shall wear tournament provided unbranded clothing (polo shirt / jacket/ hat) with the United Cup logo provided by the event whilst sat on the team bench and performing all captains' duties both on and off court; for example but not limited to official functions, walk-ons, ceremonies, photo opportunities, media appearances etc.

Captains with ongoing personal clothing sponsorship, will be permitted to wear a different shirt to the unbranded United Cup polo shirt, provided it is in the team colour or similar and is approved prior to the event.

Captains wearing a personal shirt they will still be expected to wear the United Cup unbranded jacket for official functions, walk-ons, ceremonies, photo opportunities, media appearances etc.

If captains have other ongoing personal sponsorships (patch deals etc.) and wish to wear a shirt complying with the above provision during the event with sponsor logos on the shirt, all such sponsor logos must comply with ATP/WTA tour sizing guidelines and must be approved prior to the event.

Coaches / other team members – if they are wearing shirts with sponsor logos in accordance with ATP/WTA tour sizing rules, they may sit on the team benches.

IV. WORLD CHAMPIONSHIPS

Those not complying with this requirement will need to sit in the allocated team area in the stands.

In addition, any violation occurring during the match shall be penalized with a "Coaches Warning". The first violation results in a Warning and a second violation during the match will result in the coach being removed from the court for the remainder of that Tie.

3) **Fines.** Any fines issued during the Tie will be levied against the individual.

J. Prize Money (All figures in U.S. dollars)

Total Prize Money: USD\$15,000,000 (USD\$7,500,000 each for ATP and WTA)

Per Individual Wins:

	#1 Singles Win	#2 Singles Win	Doubles Win (per player)
Final Win	\$251,000	\$169,200	\$47,255*
Semi-Final Win	\$132,000	\$89,000	\$24,750*
City Win	\$69,500	\$46,800	\$13,000
Group Win	\$38,325	\$25,900	\$7,200

*If the Tie is decided following the singles matches, the doubles match may not be played, and the money will be split evenly amongst the members of both teams.

Per Team Wins:

Team Wins	
Final Win	\$23,155
Semi-Final Win	\$13,650
City Final Win	\$8,025
Group Tie Win	\$5,000

All players on the team (whether the player plays a match or not) earn the same amount for a team win.

*Entry order as of 8 November 2022

Participation Fee:

No. 1 Player	
Singles Ranking	\$/player
1-10	\$200,000
11-20	\$100,000

IV. WORLD CHAMPIONSHIPS

No. 1 Player	
21-30	\$60,000
31-50	\$40,000
51-100	\$30,000
101-250	\$25,000
251+	\$20,000

No. 2 Player	
Singles Ranking	\$/player
1-10	\$200,000
11-20	\$100,000
21-30	\$50,000
31-50	\$30,000
51-100	\$20,000
101-250	\$15,000
251+	\$10,000

No. 3 Player	
Singles Ranking	\$/player
1-30	\$30,000
31-100	\$15,000
101-250	\$7,500
251+	\$6,000

No. 4 Player	
Singles Ranking	\$/player
1-30	\$10,000
31-100	\$7,500
101-250	\$6,000
251+	\$5,000

Ranking as of 7 November 2022

Participation Fee Notes

- Players may only receive a participation fee in one category. Players will receive a fee for singles or mixed doubles, whichever was used for their entry.

IV. WORLD CHAMPIONSHIPS

- Participation fee for any team substitutions following the 8 November 2022 entry order shall be based upon the 7 November team order and player ranking.
- A number 1 and number 2 singles player will receive 100% of the participation fee if they compete in all Group stage singles matches. Pro-Rata schedule for players number 1 and number 2 competing in less than all Group stage singles matches is listed below including Pro-Rata schedule for mixed doubles matches participated in.
- Players number 3-5 will receive 100% participation fee regardless of whether they compete in any of the Group state matches.

2023 Participation Fee Pro-Rata Schedule			
For #1 & #2 Players	Promotional %	Per Singles Match %	Per Doubles Match %
	40%	30%	15%

- Max of 30% per tie
- Playing Singles and Doubles in same tie = 15%
- Applies to Group stage matches and ties only
- This applies to all #1 & #2 players including players competing with Protected Ranking (PR)/Special Ranking
- Promotional % = minimum participation fee

*15 % maximum per all mixed doubles matches, regardless of if a player plays 1 or 2 mixed doubles during the group stage. Players competing in singles and mixed doubles in a Tie will receive the Promotional fee plus 30 % per the singles match. A #1 & #2 Player only playing 2 mixed doubles during the group stage will receive 40 % Promotional + 15 % total for both mixed doubles matches (55 % overall). Examples in the table below.

Scenario	Group Tie 1		Group Tie 2		Fee Collected
	Singles	Doubles	Singles	Doubles	
A	x		x		100%
B	x			x	85%
C	x	x			70%
D	x				70%
E		x		x	55%
F		x			55%

IV. WORLD CHAMPIONSHIPS

G	Group Tie 1		Group Tie 2		40%

K. ATP/WTA Ranking Points

Singles

Opponent's Ranking on Monday, December 26, 2022	1-10	11-20	21-30	31-50	51-100	101-250	251+
Final Win	180	140	120	90	60	40	35
Semifinal Win	130	105	90	60	40	35	25
City Win	80	65	55	40	35	25	20
Group Win	55	45	40	35	25	20	15
Max Points	500	400	345	260	185	140	110

Maximum 500 points for undefeated player

L. Walkovers

- No points are awarded if no matches of the tie are played
- An individual match in the tie is won by a Walkover, points are awarded based upon the lowest ranking category (251+).

M. Media / STARS Obligations

- All teams are requested to arrive in Australia on time for any pre-event media / STARS commitments, to be arranged.
- Normal post-match interview protocol will be followed with the exception being a player competing in the 4th singles match who is also competing in the mixed doubles may postpone his media commitment until after the mixed doubles match. However, the ATP/WTA PR Manager may approach the player following the singles match to obtain a few quotes to give to media, if requested. Jurisdiction Governing the competition

N. Jurisdiction Governing the competition

- The Competition is sanctioned and recognized by ATP Tour, Inc. and WTA Tour.
- All players who enter and compete in the competition agree to be subject to the Rules and Regulations of the ATP/WTA, including, but not limited to, the Code of Conduct, the Tennis Anti-Corruption Program and the Tennis Anti-Doping Program.
- The ATP/WTA Supervisor, in consultation with the SVP, Rules & Competition and WTA Senior Vice President Competition & On-Site Operations, shall determine and resolve all questions not considered in these Rules and Regulations.

4.04 Next Gen ATP Finals

A. Competition Format

IV. WORLD CHAMPIONSHIPS

The tournament shall be a round robin format with eight (8) players. There shall be two (2) groups of four (4) players each with eight (8) seeds to be determined by their position on the most recent Pepperstone ATP Singles Rankings. All matches shall be the best of five (5) tie-break sets. Each set shall be the first to four (4) games with a margin of two (2) with a tie-break played at three (3) games all. Games shall be decided using the No-Ad scoring method. The round robin shall determine the four (4) players for the semi-finals with the format thereafter being a single elimination competition.

B. Entries

- 1) **Age Eligibility.** All players must be 21 years or under throughout the 2023 calendar year.
- 2) **Selection List.** The selection list for the event shall be:
 - a) The top seven (7) players in the ATP Race to Milan standings as of Monday (31 Oct) following the Basel / Vienna / Challenger events; followed by
 - b) One (1) Wild Card designated by the FIT and approved by ATP. The Wild Card selection must meet the age restriction as specified in B. 1) above.
 - 3) **Direct Acceptances.** The top seven (7) players in the selection list shall qualify for the event as direct acceptances. Participation is mandatory, and all qualified players shall be entered. The exception to this is that any player(s) who are qualified for the Nitto ATP Finals as a Direct Acceptance or as a designated Alternate are excluded from mandatory participation. All direct acceptances must be at the tournament site to attend the official pre-tournament media events scheduled Sunday night and Monday and must be available for play through the completion of the round robin competition and the knock-out competition if eligible.
- 4) **Withdrawal.** Any withdrawal, before the official pre-tournament media conference starts, shall be replaced by the next highest positioned player on the selection list, who shall be qualified as a direct acceptance.
- 5) **Alternate(s).**
 - a) Alternate(s) (who are not a direct acceptance at the time of the official pre-tournament media conference) shall be designated as determined by ATP. The alternate shall replace any player who subsequently withdraws. The alternate must appear at the official pre-tournament media conference and remain available through the start of the last scheduled round robin match. Participation of the Alternate is not mandatory.
 - b) Additional alternates may be selected by ATP to fill the draw, based upon terms satisfactory to ATP. Participation of such additional alternates is not mandatory.
 - c) The alternate(s) is eligible to play in the single elimination competition and to receive prize money if he qualifies.
 - d) If the alternate(s) does not play in the draw, then a fee shall be paid to the alternate(s). If the alternate(s) is inserted for the second or third round robin match, then he shall receive the alternate fee plus any prize money won. If the alternate(s) replaces a player that does not compete in his first round robin match, the alternate(s) becomes a direct acceptance and does not receive the alternate fee.

C. Appearance at Event

IV. WORLD CHAMPIONSHIPS

All direct acceptances and the alternate must appear at the site of the event(s) as determined by ATP and participate in the pre-tournament media events scheduled on Sunday night and Monday.

D. Failure to Participate

If a player, qualified for the Next Gen ATP Finals as a direct acceptance fails or refuses to participate in this event, except for bona fide injury or other reason which constitutes good cause, the player shall receive a fine in the amount of \$25,000.

E. Order of Play

Round Robin

- 1) The field shall be divided into two (2) groups of four (4) players each. The top-seeded player shall be placed in Group "A" and the second-seeded player shall be placed in Group "B". Players seeded three (3) and four (4), five (5) and six (6), and seven (7) and eight (8), shall then be drawn in pairs with the first drawn placed into Group "A."
- 2) Each player shall play every other player in his group to determine the top two (2) players in each group.
- 3) The final standings of each group shall be determined by the first of the following methods that apply:
 - a) Greatest number of wins.
 - b) Greatest number of matches played.
Comment: 2-1 won-loss record beats a 2-0 won-loss record; a 1-2 record beats a 1-0 record.
 - c) Head-to-head results if only two (2) players are tied.
 - d) If three (3) players are tied, then:
 - i) If three (3) players each have one (1) win, a player having played less than all three (3) matches is automatically eliminated and the player advancing to the single elimination competition is the winner of the match-up of the two (2) players tied with 1-2 records; or
 - ii) Highest percentage of sets won; or
 - iii) Highest percentage of games won; or
 - iv) The player positions on the most recent Pepperstone ATP Rankings.
 - v) If (i), (ii), (iii) or (iv) produce one (1) superior player (first place), or one (1) inferior player (third place), and the two (2) remaining players are tied, the tie between those two (2) players shall be broken by head-to-head record.
Comment 1: 1 player has 3 wins and the other 3 players have 1 win. Of the 3 players with 1 win, 1 player has only played in 2 matches while the other 2 players have played 3 matches. The player who has only played 2 matches is eliminated and then the 2 remaining players revert to head-to-head results with the winner of their match advancing to the semi-finals.
Comment 2: 1 player has 3 wins and the other 3 players have 1 win and they all have played 3 matches. The tie-break for % of sets won has 1 player with a better % than the other two. This player advances to the semi-final round.
Comment 3: 3 players have 2 wins and the other player has 0 wins. The player with 0 wins is eliminated. Of the 3 players with 2 wins, they

IV. WORLD CHAMPIONSHIPS

are ordered by their % of sets won. This produces a 1, 2 & 3 order and the players finishing 1 and 2 move to the semi-final round and the player finishing 3 in % of sets won is eliminated. The player with the best % of sets won is the winner of the group.

Comment 4: 3 players have 2 wins and the other player has 0 wins. The player with 0 wins is eliminated. Of the 3 players with 2 wins, 1 player's sets won-loss is 5-2 for 71.43%; the other 2 players both have a 4-3 record in sets for 57.14%. In this case there is 1 superior player (71.43%) and the remaining 2 players are tied; it now reverts to the head to head result of the 2 remaining players with the winning player advancing as group runner-up.

Comment 5: 3 players have 2 wins and the other player has 0 wins. The player with 0 wins is eliminated. Of the 3 players with 2 wins, 2 have set won-loss records of 5-3 (62.5%) while the other player is 4-3 (57.14%). In this case, we have 1 inferior player (57.14%) and he is eliminated. The remaining two players both advance to the semi-finals with the winner of their head-to-head match advancing as the group winner.

Comment 6: 3 players have 2 wins and the other player has 0 wins. The player with 0 wins is eliminated. Of the 3 players with 2 wins, all have played 3 matches and all 3 have set won-loss records of 5-4 (55.56%). In this case, we move to % of games won. The % of games won breaks down like this: 44-40 for 52.38%, 45-43 for 51.14% and 44-43 for 50.57%. This produces a 1, 2 and 3 order of the group and the number 1 player in % of games won is the group winner while the player finishing 2nd in % of games won advances to the semi-finals as the group runner-up. The player with the 3rd best % of games won is eliminated.

- e) In applying the tie-breaking procedures, a conduct default or retirement shall count as a straight-set win or loss. However, games won or lost in matches with the defaulting or retiring player shall not be counted in the percentage of games won. A player who retires during the round robin because of illness or injury may continue in the competition if it is approved by the tournament Doctor.

Comment: This prevents a scenario where a player knows he only needs to win 1 set to qualify for the semi-finals from retiring once he has won a set.

- f) Any player who is defaulted pursuant to the ATP Code during the round robin competition shall be defaulted from all other matches in the Championship and ATP default provisions shall apply, except for the following circumstances:
 - i) The loss of physical condition; or
 - ii) Dress and Equipment.
- g) Any player who withdraws from any round robin match after the first round shall not be eligible for the single elimination competition.

F. Single Elimination Competition

- 1) The winner of each group shall be placed in separate semi-final brackets. The runner-up of each group shall be placed in the semi-final bracket with the winner of the opposite group.
- 2) The event shall be completed with a single elimination competition for the semi-finals and final.
- 3) There shall be a playoff between the losers of the two semi-final matches for the third and fourth place positions.

IV. WORLD CHAMPIONSHIPS

G. Prize Money

Final standings at the end of the tournament shall determine the prize money earned.

H. Conditions of Play

The conditions of play will be finalized and announced following the 2023 US Open.

IV. WORLD CHAMPIONSHIPS

V. PERSONNEL

5.01 Tournament Director

A. Appointment

- 1) A tournament may change the Tournament Director named in the tournament application by submitting the proposed change to the ATP Board for approval.
- 2) The ATP Board may require a tournament to change the Tournament Director upon a finding that such Tournament Director has failed to or refused to comply with any provision of ATP's rules and regulations.

B. Responsibilities

Each Tournament Director shall:

- 1) Act in cooperation with ATP staff on-site.
- 2) Be responsible for tournament compliance with all rules and regulations.
- 3) Not go on court during a match (including warm-up) or otherwise become involved in any Code of Conduct matter.

NOTE: Tournament Directors are prohibited from playing in their own event (Tour Policy).

5.02 Tour Manager

A. Appointment

ATP shall provide a Tour Manager for each ATP Tour tournament.

B. Responsibilities

- 1) The Tour Manager shall be present for all sign-ins.
- 2) The Tour Manager shall be present at the making of all draws.
- 3) The Tour Manager shall act as the player representative for all aspects of the tournament, including as a member of the scheduling committee.

5.03 Public Relations ("PR")

A. Appointment

- 1) ATP will provide a PR representative for each ATP Tour tournament to coordinate advance publicity, help organize facilities and provide media assistance on-site.

B. Responsibilities

- 1) The PR representative shall liaise with journalists, players and sponsors.
- 2) The PR representative shall organize and supervise post-match press conferences.
- 3) The PR representative shall coordinate exclusive interviews.
- 4) The PR representative shall provide statistical and biographical information to journalists.
- 5) The PR representative shall disseminate information to international journalists.
- 6) The PR representative shall suggest story lines to journalists.

V. PERSONNEL

5.04 Doctor, Physiotherapist and Massage Therapist

A. ATP Tour Tournaments

1) Tournament Doctor.

Beginning with the qualifying competition, it is the responsibility of each ATP Tour tournament to provide on-site during the entire tournament an English-speaking Doctor who specializes in sports medicine, unless otherwise approved by ATP's Medical Services Committee. Each tournament shall send the name and address of the tournament Doctor to the appropriate ATP regional coordinator forty-two (42) days in advance of the tournament. The tournament doctor shall be responsible for the medical care and treatment of the players at all times during the event and shall have no other official duties while at the tournament site. ATP Masters 1000 and ATP 500 tournaments shall provide for the Tournament Doctor, a private space in the vicinity of the ATP Physiotherapist area.

2) Physiotherapist.

ATP shall provide a Physiotherapist for all tournaments except that ATP may require assistance from a tournament to provide a Physiotherapist for the qualifying competition.

Combined Events. Each combined tournament must provide one (1) ATP Physiotherapist with single room hotel accommodations. Complimentary room shall be in the player hotel or another hotel approved by ATP Medical Services.

3) Massage Therapist.

It is the responsibility of each ATP Tour tournament to provide a Massage Therapist in the following amounts: (i) 96-draw: 5, (ii) 56-draw: 4, (iii) 48-draw: 3, and (iv) 32-draw: 2.

B. ATP Challenger Tour Tournaments

1) Tournament Doctor. Each ATP Challenger Tour tournament is required to have an English-speaking tournament Doctor at the site from one (1) hour prior to the start of play through its conclusion on each day. If the ATP Challenger Tour tournament cannot provide a doctor on-site during all hours of play, a doctor shall be available during all hours of play on each day:

- a) On call and able to respond immediately for consultation from the tournament medical team by telephone on each day for urgent medical situations that arise; and
- b) Through a schedule of daily on-site visits (minimum 1 hour during normal business hours or as required by the ATP Supervisor) by the tournament doctor established at the start of the tournament and posted in the player treatment room to allow for in-person consultations with player as needed throughout the tournament and within the allocated time frame for each day; and
- c) To see a player in-practice (physician's office) if a player, for reasons outside his own control, requires a doctor's consultation outside the daily allocated time frame for the doctor's on-site visit.

Each tournament shall send the name and address of the tournament Doctor to ATP's Medical Services Committee forty-two (42) days in advance of the tournament.

V. PERSONNEL

Case: A player requests to see the doctor for an in-practice consultation outside the doctor's scheduled on-site visit time slot for that day. He claims that he has an early match that day (non-urgent reason) and will likely not be on-site later in the day during the doctor's on-site visit.

Decision: The request is denied. The player can organize transportation to the site and consult with the doctor during the doctor's on-site visit.

2) Physiotherapist. Each ATP Challenger Tour tournament must provide an English-speaking Physiotherapist(s) as shown below. All Physiotherapy treatments are provided to players free of charge.

a) Challenger 125 and 175 events

- i) Two (2) Physiotherapists designated and paid for by ATP.
- ii) The tournament may apply to have a local physiotherapist in lieu of the 2nd ATP Physiotherapist. If approved, the local physiotherapist would work Saturday through Thursday. All fees and expenses for the local Physiotherapist will be paid by the tournament.

b) Challenger 100 events

- i) One (1) Physiotherapist designated and all fees/expenses paid by ATP.
- ii) One (1) Physiotherapist nominated by the tournament and approved by ATP. This Physiotherapist is to be scheduled to work Saturday through Thursday with all fees/expenses paid by the tournament.

c) Challenger 50 and 75 events

- i) Two (2) Physiotherapists designated by the tournament and approved by ATP.
- ii) The tournament is responsible for all fees and expenses.
- iii) One Physiotherapist to work Saturday through Thursday and one physiotherapist to work Sunday through Sunday.

d) Education module. All non-ATP Physiotherapists must have successfully completed the ATP Medical Services education online program prior to working at ATP Challengers.

3) Massage Therapist. One (1) Massage Therapist must be provided at each Challenger.

- At Challenger 50 and 75 events, the second Physiotherapist may work as the Massage Therapist.

- a) For Challenger 125 and 175 events, the service shall be provided to the players, while remaining in the event, free of charge.
- b) For all other Challenger Tour events, a fee may be charged with a recommended maximum fee of \$25/€25 for a 30-minute massage.

5.05 Agents, Tier I and Tier II

A list of Tier I and Tier II Agents will be established and revised on a yearly basis following the conclusion of the Nitto ATP Tour Finals. The criteria for becoming a Tier I or II Agent is defined below.

V. PERSONNEL

A. Tier I

- 1) Minimum of five (5) years of service, beginning with the first year's representation of an ATP player, and
- 2) Agent's Player must be active, and
- 3) Number of Singles Players representing
 - a) Ranking 1-10 = 1 player, or
 - b) Ranking 11-50 = 2 players, or
 - c) Ranking 11-100 = 4 players, or
- 4) Number of Doubles Players representing
 - a) Ranking 1-20 = 4
 - b) If agent does not represent four (4) doubles players, each doubles player ranked in the top 20 shall count as ½ player towards meeting the singles criteria.

B. Tier II

Agents that do not meet the criteria to be in Tier I may apply for consideration as a Tier II Agent. There are no benefits associated with Tier II classification.

5.06 Supervisor

A. Assignment & Designation

1) ATP Tour Tournaments

An ATP Supervisor shall be provided by ATP for each ATP Tour tournament.

2) ATP Challenger Tour Tournaments

ATP shall provide a Supervisor for each ATP Challenger Tour tournament.

B. Fees and Expenses

ATP Tour and ATP Challenger Tour Tournaments

ATP shall pay the fees and travel expenses of the supervisors hired by ATP.

Each tournament must provide each Supervisor with single room hotel accommodations, meals and laundry. Complimentary rooms shall be in the player hotel or another hotel approved by ATP or the Supervisor.

C. General

The Supervisor at each ATP Tour and ATP Challenger Tour tournament is provided by ATP. Whenever the Supervisor is not available, the Supervisor shall designate an approved Referee or ATP Official to assume all duties and responsibilities. (All references to Supervisor includes "or his designee.")

D. Responsibilities

In all ATP Tour and ATP Challenger Tour tournaments the Supervisor shall:

- 1) Act as ATP's representative, speaking with the full authority of ATP during the tournament.

V. PERSONNEL

- 2) Act as final on-site authority ensuring that the tournament is conducted fairly in accordance with ATP's Rules and Regulations as to all matters arising that require immediate resolution at the tournament site including the evaluation of tournament compliance with Facilities and On-Site Condition requirements.
- 3) Issue player conduct fines as necessary and appropriate.
- 4) Direct, supervise, instruct and evaluate the Referee, Chief of Umpires and all on-court officials, including the authority to:
 - a) Make the assignment of all Chair Umpires and approve all Line Umpires and net judge for tournament matches.
 - b) Remove a Chair Umpire and/or remove, rotate or replace any Line Umpire or net judge when necessary to improve the officiating of a match.
- 5) Make all draws for the qualifying and main draw competitions.
- 6) When weather or other conditions threaten the immediate safety of the players, spectators, officials or any other persons on the tournament site, the Supervisor may suspend or postpone the match(es) until such time that in his opinion the threat to safety is no longer evident.
- 7) Decide if a court is fit for play or decide if a match should be moved to another court. The Supervisor may, if necessary to eliminate the possibility of a player having to play two singles matches in one day, or if necessary to complete the event, move a match to another court, indoors or outdoors, regardless of surface.
- 8) Serve as the Chairman of the scheduling committee and make the final decision on all scheduling matters if the committee is not in agreement. Ensure that the daily order of play is posted on the bulletin board and at the official hotel.
- 9) Designate a highly visible place in the general player area as the official bulletin board.
- 10) Designate a visible timepiece at a fixed location as the "Official Clock" of the tournament.
- 11) Designate a specific area from which matches shall be called and determine when a match is to be called.
- 12) Maintain a continuous dialogue during the week with the Tournament Director and submit a report to ATP evaluating the tournament, including attendance, and officials. The Tournament Director shall receive a copy of the report prior to the Supervisor's departure.
- 13) Decide with the Tournament Director the designation of the lowest tier of seats that surround the playing area of the courts at each tournament.

E. Clothing - ATP Tour

The officiating uniform provided by ATP must be worn. No other commercial branding may be applied to the uniform without prior approval from ATP.

5.07 Chair Umpire / Review Official

A. Assignment and Designation Process

- 1) ATP Tour Tournaments. Officials required to support the tournament are as follows:

V. PERSONNEL

ATP shall hire designated Chair Umpires as follows:

<u>Main Draw Size (Singles)</u>	<u>Total # of chair Umpires</u>
96	9
56	7
48	5
32	4
28	4

NOTE: In the event the tournament elects to employ the services of an electronic line calling system, ATP will hire a Review Official in addition to the Chair Umpires as stated above.

Each tournament is required to provide supplemental Chair Umpires approved by ATP for the qualifying competition as well as for some main draw matches not covered by the designated Chair Umpires hired by ATP. Supplemental Chair Umpires must have international certification of Gold, Silver or Bronze.

- 2) **ATP Challenger Tour Tournaments.** Tournaments must hire Chair Umpires as specified below:
- Chair Umpires.** Each tournament shall have a minimum of four (4) designated Chair Umpires for the entire week as selected and coordinated by ATP. Under special circumstances, ATP may require additional Chair Umpire(s) to be hired by the tournament.
 - Supplemental Chair Umpires.** Each tournament shall provide supplemental Chair Umpires approved by ATP for matches not covered by the designated Chair Umpires. Supplemental Chair Umpires must have certification of Gold, Silver, Bronze or White.

B. Fees and Expenses

ATP shall pay the fees and travel expenses of the designated Chair Umpires and review officials (if any) hired by ATP.

1) ATP Tour and ATP Challenger Tour Tournaments.

Each tournament must provide each designated Chair Umpire and Review Official (if any) with single room hotel accommodations, meals and laundry. Complimentary rooms shall be in the player hotel or another hotel approved by ATP or the Supervisor.

Each ATP Challenger Tour tournament shall pay a fair and reasonable fee and travel expense to each Chair Umpire hired by the tournament.

C. General

Chair umpires are assigned matches by the ATP Supervisor and are responsible to ensure those matches are conducted according to the rules of ATP in order to present a professional tournament.

D. Responsibilities

- 1) Enforce all ATP Rules and Regulations and on-court procedures to ensure accuracy, fairness and safety. Ensure that the players and all on-court officials observe the rules.

V. PERSONNEL

- 2) The following pertain to the rules for continuous play: Have a stopwatch in his possession which shall be used to time the warm-up, the time between points, the time permitted on changeovers, the time permitted during the set break and all other specified time periods designated under the provisions of any rule or regulation.
- 3) Dress uniformly with other Chair Umpires as prescribed by the Supervisor.
- 4) If appropriate, conduct a pre-match meeting with all of the on-court officials for the match to specify court assignments and the procedures to be used for making calls, hand signals, rotation of court assignments, etc.
- 5) Ascertain prior to matches from the Supervisor or the Chief of Umpires that the tournament has made appropriate arrangements for the safe escorting of players to and from the court before and after the match.
- 6) Immediately before the start of the match meet with the players to:
 - a) Verify the correct pronunciation of the player's names.
 - b) State any pertinent information (rule changes, new procedures, etc. for the players.
- 7) Flip a coin in the presence of both players or teams to determine choice of serve and side at the beginning of the match prior to the warm-up. If play is suspended before the match begins, the winner of the toss may choose again before the match commences.
- 8) Determine if each player is dressed in accordance with the dress provisions of ATP rules. Corrective action taking more than fifteen (15) minutes shall result in a default in consultation with the Supervisor. An appropriate re-warm-up may be authorized.
- 9) Determine all Questions of Fact arising during the match (including the permitted five (5) minute warm-up).
- 10) Make the first determination of all Questions of Tennis Law arising during the match, subject to the right of a player to appeal to the Supervisor.
- 11) Announce the score after each point in accordance with On-Court Procedures. Announcements as a minimum must be in English. If two (2) languages must be used, announce in the local language first, then English. Conversations between the Chair Umpire and a player can be in any language. However, if the language used is not English, then the Chair Umpire must be prepared to advise the other player of the nature of the discussion.
- 12) Repeat the calls of a Line Umpire or net judge if the call is made in a weak voice or there is a close call that must be confirmed to remove any doubt from the minds of the players.
- 13) Be responsible for any ball mark inspection on clay courts. A ball mark inspection must be made in accordance with the approved on-court procedures.
- 14) Overrule a Line Umpire only in the case of a clear mistake by the Line Umpire and only if the overrule is made promptly after the mistake is made. All overrules must be made in accordance with the approved on-court procedures. Obvious foot faults must be called by the Chair Umpire consistent with the procedures used for handling "clear mistakes".
- 15) Remove, rotate or replace any Line Umpire or net judge whenever, in the opinion of the Chair Umpire, it will improve the officiating of a match.

V. PERSONNEL

- 16) Exercise his best efforts to control the crowd. Spectator involvement is encouraged as long as the Chair Umpire does not determine such involvement to be deliberately distracting. Whenever the spectators are impeding the progress of the match, the Chair Umpire should address them respectfully and request their cooperation. The tournament announcer and security personnel may be used to assist the Chair Umpire after consultation with the Supervisor.
- 17) Be responsible for the direction of the ball persons during the match so that they assist but do not disturb the players.
- 18) Be responsible for having the appropriate number of balls on-court for the match, for all changes of balls and for determining if a ball is fit for play. The appropriate number of ball containers should be opened and inspected sufficiently in advance of each ball change so as to avoid any delay of the match at the time of a ball change.
- 19) Complete a scorecard in accordance with the approved on-court procedures. Following the completion of a match, the scorecards or printouts are to be finalized and distributed to appropriate ATP tournament and/or media personnel. Maintain the ATP Point Penalty Card in accordance with the approved on-court procedures.
- 20) Determine if a court continues to be fit for play. If a change in condition occurs during a match that the Chair Umpire considers sufficient to make the court unfit for play or if weather conditions require stoppage of play, he should stop play and immediately notify the Supervisor.
- 21) Following the conclusion of the match, complete and give to the Supervisor, the Post Match Review form including all actions taken under the Code during the match. If required by the Supervisor, in addition to the brief summary of the violation made on the Point Penalty Card, the Chair Umpire shall write a detailed statement of the incident. All reports shall be signed, dated and delivered to the Supervisor.
- 22) Chair umpire responsibilities to include primary responsibility to call nets or throughs, unless otherwise assigned.
- 23) Chair umpires must promptly and accurately score matches using the handheld or other method provided by ATP. In addition, Chair Umpires agree not to, and shall not authorize or assist any third party to, disseminate, transmit, publish or release any match related data or information to or for any third party without the express written consent of ATP. Further, each Chair Umpire agrees that any and all work or data he/she collects or creates in connection with any match shall constitute a "work made for hire" and any and all rights attributable to such work shall be retained by, or if necessary automatically assigned to, ATP and its members.

E. Clothing - ATP Tour

The officiating uniform provided by ATP must be worn. No other commercial branding may be applied to the uniform without prior approval from ATP.

V. PERSONNEL

5.08 Line Umpire

A. Assignment and Designation Process

1) ATP Masters 1000 Tournaments

Officials required to support the tournament are as follows:

Unless otherwise approved by ATP, the following are required: a minimum of seven (7) Line Umpires must be provided per main draw match and qualifying match.

2) ATP 500 and 250 Tournaments

Officials required to support the tournament are as follows:

Unless otherwise approved by ATP, the following are required: A minimum of seven (7) Line Umpires must be provided per main draw match. A minimum of five (5) Line Umpires per qualifying match must be provided.

3) ATP Challenger Tour Tournaments

Tournaments must hire officials as specified below:

For Challenger 50 and 75 events on clay court, a minimum of three (3) Line Umpires shall be provided for every qualifying match and also every main draw match up until the quarterfinal. From the quarterfinals on, a minimum of five (5) Line Umpires shall be provided.

For Challenger 50 and 75 events on hard, grass or indoor synthetic court, a minimum of five (5) line umpires shall be provided for every qualifying and main draw match.

For Challenger 100 and 125 events, regardless of court surface, a minimum of five (5) Line Umpires shall be provided for every qualifying and every main draw match up until the quarter-finals. From the quarter-finals on, a minimum of seven (7) Line Umpires shall be provided.

For Challenger 175 events, a minimum of five (5) Line Umpires shall be provided for every qualifying match. A minimum of seven (7) line umpires shall be provided for every main draw match.

B. General

Line umpires are assigned by the Chief of Umpires and are responsible for calling their assigned lines according to ATP rules under the direct on-court supervision of the Chair Umpire.

C. Clothing

Clothing provided by the tournament for Line Umpires shall not be solid white, yellow or other colors that may interfere with the vision of the players, unless otherwise approved by ATP. It is recommended that dark-colored clothing be avoided for outdoor tournaments played in high temperatures. Clothing should not be identical to clothing provided to the ball persons.

D. Responsibilities

- 1) Carry out all duties in accordance with the approved procedures of ATP.
- 2) Not catch balls or hold towels for a player.

V. PERSONNEL

- 3) Not leave the court without permission of the Chair Umpire.
- 4) Dress uniformly with other Line Umpires as prescribed by the tournament and/or ATP.
- 5) Sit erect with both feet on the ground with arms resting on his or her legs.
- 6) Concentrate on the assigned line; conversation with spectators or others is to be avoided.
- 7) Be accountable to the Chair Umpire only and have no discussions with the players. A player's questions must always be referred to the Chair Umpire. However, a Line Umpire may answer a reasonably precise question if it relates to a call, especially foot faults, unless that call has been overruled.
- 8) Move away from the on-court chair if necessary to get the best view possible of the assigned line.
- 9) Make all calls as quickly as possible, maintaining consistency and accuracy. On very close calls a fraction of a second's hesitation is recommended to make sure that the call is correct.
- 10) Never call a ball "Out" until it actually hits out or it hits a permanent fixture.
- 11) Make "Out," "Fault," "Net" and "Foot Fault" calls loudly and crisply followed by the appropriate hand signal. Foot faults are never called until the serve is struck.
- 12) Do not make a call for a "good" ball. However, whenever there is a close call on a good ball, the "good" ball hand signals should be given quickly to confirm the call.
- 13) When there is an erroneous call, immediately call "Correction" so that the Chair Umpire and the players are aware of the error. Then, make the corrected call.
- 14) Do not give an opinion on a call that is not his or her responsibility.
- 15) Remain silent if the Chair Umpire overrules a call. Direct player inquiries to the Chair Umpire.
- 16) If directed by the Chair Umpire to identify a mark, and the Line Umpire is sure of the location of the mark, the Line Umpire should walk directly to the mark and point to it in a manner that is clear to the Chair Umpire. The Line Umpire should then return to his position without comment.
- 17) Promptly yield to the Chair Umpire when unsighted on a call.
- 18) If the Line Umpire sees that he or she may hinder a player's stroke, make a reasonable effort to get out of the way, but in so doing, make as little movement as possible.
- 19) When there are Code Violations by players not witnessed by the Chair Umpire, inform the Chair Umpire immediately or as soon as is reasonable prior to the start of the next point, without disrupting a point or the match. The Line Umpire should quickly approach the Chair Umpire and report the facts of the violation.

5.09 Referee

A. Assignment and Designation Process

1) ATP Tour Tournaments

Each tournament is required to hire a certified Referee approved by ATP.

V. PERSONNEL

2) ATP Challenger Tour Tournaments

Each tournament is required to hire a certified Referee approved by ATP.

B. Waiver of Obligation – Referee

A tournament may petition ATP to waive the Referee requirement. Waivers shall not be granted to:

- 1) Challenger 125 and 175 events
- 2) Any new Challenger tournament
- 3) Tournaments played on two (2) separate sites, including qualifying
- 4) Back-to-back tournaments (for a minimum of the overlapping week-end)

Furthermore, the following elements shall be used to determine whether or not a waiver will be considered:

- 1) 2-court event
- 2) Venue size
- 3) Recommendation of the supervisor from previous year that a waiver, if approved, will not jeopardize the quality of the service.

Where a waiver is granted, tournament shall provide a suitable assistant to the supervisor.

C. Fees and Expenses

1) ATP Tour and ATP Challenger Tour Tournaments

Each tournament must provide each Referee with single room hotel accommodations, meals and laundry. Complimentary rooms shall be in the player hotel or another hotel approved by ATP or the Supervisor.

Each tournament shall pay a fair and reasonable fee and travel expense to each designated and approved Referee hired by the tournament.

D. General

The Referee is hired by the tournament to advise in planning the event and shall assist the Supervisor while being available to serve on the scheduling committee.

E. Responsibilities

Advise, assist and cooperate with the Supervisor as appropriate and necessary when carrying out any assigned duties or responsibilities. Assigned duties may include;

- 1) Organizing the facilities, equipment and staff, to support play beginning with the qualifying competition.
- 2) Confirming the conditions of play, (i.e.), make and number of tennis balls, types of beverages including electrolyte, how matches are to be called, etc.
- 3) Ensure that each court is equipped as follows:
 - a) Umpire's chair.

V. PERSONNEL

- b) Line umpire chairs.
 - c) Player's chairs.
 - d) On-court beverages.
 - f) Writing Tables and electrical outlet for the Electronic Scoring Device.
 - g) Microphones (if applicable)
- 4) Designate a highly visible place in the general player's area as the "Official Bulletin Board" and notify all players of its designation and location.
 - 5) Make appropriate arrangements for the safe escorting of players to and from the court before and after the match.
 - 6) Be on-site at all times during the playing of matches in the tournament. The Referee may not be a Chair Umpire or Chief of Umpires.

5.10 Chief of Umpires

A. Assignment and Designation Process

ATP Tour and ATP Challenger Tour tournaments are required to hire a certified Chief of Umpires approved by ATP, unless otherwise determined by ATP.

B. Fees and Expenses

1) ATP Tour and ATP Challenger Tour Tournaments

Each tournament must provide each Chief of Umpires with single room hotel accommodations, meals and laundry. Complimentary rooms shall be in the player hotel or another hotel approved by ATP or the Supervisor.

Each tournament shall pay a fair and reasonable fee and travel expense to the Chief of Umpires hired by the tournament.

C. General

The Chief of Umpires is approved by ATP, hired by the tournament and is responsible for having sufficient quality Line Umpires assigned to each match.

D. Responsibilities

- 1) Recruit a sufficient number of competent officials for the tournament. Be prepared to respond to or make recommendations to the Fulltime Official who is coordinating assignments and designations of all necessary and required Chair Umpires.
- 2) Conduct the necessary pre-tournament training of officials including review of all appropriate ATP Rules and Regulations.
- 3) Prepare a list of officials, which shall include the mailing address and national or local certifications, if any, of all officials used during the tournament. A copy of such list shall be delivered to the Referee and to the Supervisor.
- 4) Be on-site at all times during play. The Chief of Umpires may not be a chair or Line Umpire unless authorized by the Supervisor.
- 5) Schedule the on-court assignments of Line Umpires for each day of the tournament, subject to the approval of the Supervisor. Line umpires for the quarterfinals,

V. PERSONNEL

semi-finals and finals must have worked a minimum of two (2) days prior to the quarterfinals and have the Supervisor's specific approval.

5.11 Ball Persons

Each ATP Tour and ATP Challenger Tour tournament must provide ball persons for all main draw and qualifying competition matches. Ball persons should be on-site and available at a reasonable time prior to the first match of the day and there shall be ball persons available until the conclusion of play each day.

A. Number.

At ATP Tour events, six (6) ball persons are recommended per court. At Challenger Tour events a minimum number of four (4) ball persons is required per court, although it is recommended to provide six (6).

B. Clothing

Clothing provided by the tournament for ball persons shall not be solid white, yellow or other colors that may interfere with the vision of the players, unless otherwise approved by ATP. It is recommended that dark-colored clothing be avoided for outdoor tournaments played in high temperatures. Clothing should not be identical to clothing provided to the Line Umpires.

5.12 ATP/GRAND SLAMS/ITF/WTA Code of Conduct for Officials

A. The ATP, the Grand Slam Tournaments, the ITF and the WTA as members of the Joint Certification Programme require a high standard of professionalism from all Certified Officials (National, Green, White, Bronze, Silver and Gold) and all other Officials, (together, "Officials") working at ATP, Grand Slam, ITF and WTA events. All Officials are automatically bound by, and must comply with, this Code of Conduct for Officials ("Code"). The ATP, Grand Slam Board, ITF and WTA shall continue to have jurisdiction over a retired Official under the Code and, as applicable, ATP, Grand Slam, ITF and WTA Tournament Regulations and Codes of Conduct in respect of matters taking place prior to his/her retirement.

The full text of the Code of Conduct for Officials can be found at the following website: <https://officiating.itftennis.com/rules/code-of-conduct-for-officials/>.

V. PERSONNEL

VI. FACILITIES & ON-SITE CONDITIONS

6.01 Courts

A. Court Surface

- 1) Outdoor court surfaces shall be classified as either a) hard; b) clay; or c) grass.
- 2) Indoor surfaces shall be Indoor Hard and shall be constructed using an acrylic or similar surface paint applied on a hard or semi-hard base.
- 3) Any court surface or change in a tournament's court surface must be approved by ATP.
- 4) A change in a tournament's court surface will not be considered for approval without a written petition by the tournament.

B. Size, Position and Color of Courts

- 1) The Court shall conform to the specifications of the [Rules of Tennis](#). ATP reserves the right to restrict the color of an indoor synthetic court as well as outdoor surfaces. The lines of the court shall be white.
- 2) Courts shall be laid out with the long axis north and south; however, geographic considerations may modify this orientation in order to minimize the adverse effect of serving into the sun.
- 3) Courts shall not be less than 60 feet (18.29 m.) wide and 120 feet (36.58 m.) long. Center courts should be 66 feet (20.11 m.) x 132 feet (40.23 m.).

C. Preparation of Surface

Clay, composition and loose surface courts shall be swept and lines cleaned before the start of all matches and properly maintained.

D. Lighting

- 1) **Minimum Number of Lighted Courts** – Outdoor events
 - a) ATP Tour Masters 1000. Center Court, two (2) other show courts plus one (1) practice court.
 - b) ATP Tour 500. Center Court plus one (1) other show court plus one (1) practice court based on match schedule plan.
 - c) ATP Tour 250. No minimum requirement.
- 2) **Intensity**
 - a) **ATP Tour Tournaments.** Lighting must be evenly distributed on the court with a minimum recommended intensity of 100 foot-candles (1076 LUX), averaged over 15 readings on court.
The recommended minimum lighting for televised events broadcasting in high definition is an average of 185 foot candles (approximately 2,000 lux). The light should be distributed across the court evenly with a consistent color temperature.
 - b) **ATP Challenger Tour Tournaments.** Lighting must be evenly distributed on the court with a minimum recommended intensity of 70 foot-candles (750 LUX), averaged over 15 readings on court.
- 3) **High/low ratio.** A ratio of the highest to lowest readings should be no greater than 1x2.0 but the recommended ratio is 1x1.5.

VI. FACILITIES & ON-SITE CONDITIONS

- 4) Light poles.** Light poles should be positioned so that they are evenly distributed around the court and it is recommended that light pole heights for other than show courts be no lower than forty (40) feet (12.19 m.) or no lower than other non-show court lights at the facility, e.g., if others are sixty (60) feet (18.29 m.), then new lights should be sixty (60) feet (18.29 m.) high.
- 5) The Supervisor has the authority to suspend play on any court if the intensity of illumination, in his judgment, is insufficient for professional tennis.**

E. Back Fences, Back Walls, Banners, Signs and Seats

- 1) The back fences, back walls, net, net posts, Line Umpire boxes and other fixtures on a court shall not have any white, gray, yellow or other light colors that can interfere with the vision of the players as determined by the Supervisor.**
- 2) Background and lettering on rotating / LED banners should be consistent with the color of the back walls. If placed in front of back walls, rotating / LED banners can change between games. The ATP may approve the use of entertainment images / changes after every point if not disturbing play. If placed in front of side walls, rotating / LED banners can change only after the completion of any point in progress. ATP Tour Masters 1000 and ATP Tour 500 tournaments are recommended to install LED banners around their center court (both backwall and sidewall boards).**

Each ATP Tournament must comply with the following in order to use electronic perimeter boards (LEDs):

- a) The company and methodology used to produce electronically inserted signage must meet quality and technical standards and be pre-approved by ATP.**
 - b) Electronically inserted signage may be used across the whole court perimeter.**
 - c) Electronically inserted signage may be altered only between points and operator must insure through synchronisation with the umpire's tablet and a view of the court, that such changes do not happen during play.**
 - d) Only static logos may be inserted during play. Animations or videos may be inserted between points so long as static logos are featured as soon as players are ready to serve/receive.**
 - e) Electronically inserted signage must be compliant with colour restrictions and brightness of the LED boards at the supervisor's discretion.**
- 3) Spectator seating shall not have any white, gray, yellow or other light colors that can interfere with the vision of the players. Light colored seats shall be covered to comply with this rule.**

F. Ceiling Height.

- 1) ATP Events.** Indoor or covered show courts shall have a minimum top height of forty (40) feet (12.19 m.) except as otherwise approved by ATP.
- 2) Challenger Events.** Indoor or covered show courts shall have a minimum top height of thirty (30) feet (9.14 m. except as otherwise approved by ATP.

G. On-Court Timing Devices.

It is mandatory for all ATP Tour events (250-500-1000-United Cup-Nitto ATP Finals) to provide electronic timing devices ("shot clocks") on each match court from the first day of qualifying through the finals.

VI. FACILITIES & ON-SITE CONDITIONS

- 1) Size.** Each shot clock panel's minimum recommended size is 2 x 2 feet (0.6 x 0.6 meters). The recommended maximum size is 3 x 2 feet (0.91 x 0.6 meters).
- 2) Number and Placement.** Each court shall have, as a minimum, two (2) timing panels. The placement of the shot clock panels shall be on the back wall or corner of the court and located one (1) each on the left far and right far side from the umpire chair. The placement shall ensure that the shot clock is in clear view of the players and the Chair Umpire.
- 3) Additional Positions.** Beyond the two (2) clock placements specified in 2) above, at the tournament's option they may show the shot clock timing in other locations on or around the court and spectator areas.

H. Electronic Review.

- 1) With the exception of clay court events, all ATP Tour tournaments are required to provide an ATP approved electronic review system.**
Note: ATP approved electronic review systems is permitted for use at clay court events in 2023 on a voluntary basis.
- 2) The system must, at a minimum, be available for use on the Stadium/Centre Court.**
- 3) Masters 1000 and ATP 500.** The system must be available from the first day of qualifying* through the end of the event on all show courts.
- 4) ATP 250 Events.** If qualifying and main draw matches are scheduled on the same day and on the same court(s), then the electronic review must be used for all matches on that court(s).
- 5) The tournament must comply with all of the provisions specified in "Exhibits T - and U".**

*If qualifying matches are played on courts where an electronic review system is installed, then the electronic review system must be used from the first day of qualifying.

6.02 Match and Practice Courts

A. Each tournament must provide match and practice courts as follows:

ATP Tour Masters 1000 96-draw (Combined)	9 match courts 8 practice courts (on-site)
ATP Tour Masters 1000 96-draw (Outdoors)	6 match courts 4 practice courts (on-site)
ATP Tour Masters 1000 56-draw (Outdoors and Combined)	8 match courts 8 practice courts (on-site)
ATP Tour Masters 1000 56-draw (Indoors)	3 match courts 4 practice courts (minimum 1 on-site)
ATP Tour 500 (Outdoors)	5 match courts 4 practice courts (minimum 3 on-site)

VI. FACILITIES & ON-SITE CONDITIONS

ATP Tour 500 (Indoors) 3 match courts
4 practice courts (minimum 1 on-site)

ATP Tour 250 (Outdoors) 3 match courts
1 practice court for every 16 players in
singles draw (minimum 2)

ATP Tour 250 (Indoors) 2 match courts
1 practice court for every 16 players in
singles draw (minimum 2)

ATP Challenger Tour 3 match courts
(Outdoors)* 1 practice court for every 16 players in
singles draw (minimum 2)

ATP Challenger Tour (Indoors) 2 match courts
1 practice court for every 16 players in
singles draw (minimum 2**)

All courts must be the same surface, color, speed and conditions.

For combined events, the minimum number of match/practice courts must be available exclusively to ATP.

* Minimum number of match/practice courts will be reviewed and approved on a case by case basis. Factors considered when determining minimum number of courts include, but are not limited to, daylight hours, night sessions, number of lighted courts meeting or exceeding minimum requirement.

** Existing indoor events where meeting the minimum requirement is not possible may appeal for a waiver.

B. All match and practice courts must be the same surface, speed and conditions as the main draw and must be available for practice from 9:00 A.M. on Friday prior to the start of the tournament until the conclusion of the tournament.

For ATP Challenger Tour tournaments, practice courts to be available from 12:00 Noon on the Saturday preceding the start of the tournament (Friday, in case of Sunday to Saturday schedule).

C. Courts must be set up to provide normal support, including drinks (bottled water), sawdust and towels.

6.03 Balls

Tennis balls used at ATP Tour and ATP Challenger Tour tournaments must be approved by ATP a minimum of ninety (90) days prior to the start of the tournament.

A. Changes and Number.

Ball changes and the number of balls used per match shall be the same for all main draw matches throughout the tournament unless authorized by the Supervisor. Balls should be opened just prior to the match or ball change. In case of a suspended or postponed match, the match balls shall not be used in the warm-up, they shall only be used when play resumes. Each tournament must provide approved tennis balls in accordance to the following:

VI. FACILITIES & ON-SITE CONDITIONS

- 1) **ATP Tour Tournaments:** Six (6) balls for each main draw and qualifying match to be changed after seven (7) and nine (9) games throughout the tournament.
- 2) **ATP Challenger Tour Tournaments:** It is recommended that all Challenger events use six (6) balls, changed after seven (7) and nine (9) games for all matches, however, it is mandatory for Challenger 125 and 175 events. For all other challenger events, as a minimum, four (4) balls are to be provided for each main draw and qualifying match to be changed at least every seven (7) and nine (9) games.

B. Lost Balls. Play must be continuous even if a ball needs to be replaced.

- 1) **ATP Tour Tournaments:** If a ball is lost or becomes unplayable, then another shall be added as soon as it is reasonably possible. During the warm-up or within two (2) games (before first point is begun in the third game or if the first point has to be replayed for any reason) after a change of ball, a new ball shall be used as a replacement; otherwise a ball of like wear shall be supplied.
- 3) **ATP Challenger Tour Tournaments:** If a ball is lost or becomes unplayable and there are fewer than three (3) balls remaining, then another ball must be added immediately for use in play. During the warm-up or within two (2) games (before first point is begun in the third game or if the first point has to be replayed for any reason) after a change of balls, a new ball shall be used as a replacement; otherwise a ball of like wear shall be supplied.

C. Practice Balls

- 1) **ATP Tour Masters 1000 and ATP 500 Tournaments:** Each main draw player is entitled to twelve (12) new balls per day for practice, free of charge, one (1) day prior to the start of qualifying until that player is eliminated. Once eliminated, he shall be entitled to six (6) new balls per day for practice. Players must return practice balls.
- 2) **ATP 250 Tournaments:** Each main draw player is entitled to nine (9) new balls per day for practice, free of charge, one (1) day prior to the start of qualifying until that player is eliminated. Once eliminated, he shall be entitled to six (6) new balls per day for practice. Players must return practice balls.
- 3) **ATP/Challenger Qualifying Competition:** Players listed in the Pepperstone ATP Rankings (singles/doubles) who are practicing for qualifying competition are entitled to three (3) new balls per day for practice, free of charge, one (1) day prior to the start of the qualifying competition until that player is eliminated. Players must return practice balls. For ATP Tour qualifying at combined events, each player is entitled to six (6) new balls per day until that player is eliminated.
- 4) **ATP Challenger Tour Tournaments:** Each main draw player is entitled to three (3) new balls per day for practice (six (6) balls for Challenger 125 and 175 events), free of charge, from 12 Noon Saturday (Friday for events with a Sunday start) prior to the start of the event until that player is eliminated. Once eliminated, he shall be entitled to three (3) used balls per day for practice (six (6) balls for Challenger 125 and 175 events). Players must return practice balls.

D. Ball Logo. Tournaments may add an additional logo to the tournament ball under the following conditions.

- 1) The logo is no larger than the logo of the ball manufacturer, and

VI. FACILITIES & ON-SITE CONDITIONS

- 2) The logo is positioned on the side of the ball opposite the ball manufacturer logo.

Ball Change Error

Case: A player serves a first service fault. He starts to serve the second serve and the Chair Umpire realizes that there should be new balls in play.

Decision: The Chair Umpire should wait to change balls until that player or team is scheduled to serve (Rules of Tennis, "Rule 27"), unless a let is called resulting in the first point being replayed.

New Balls to Wrong Player(s)

Case: The wrong player or team was given new balls with which to serve.

Decision: If the error is discovered after the first point, then the team/player continues to serve with the new balls. The team/player who should serve with new balls receives new balls to serve the next game. Once a point has been played in the second game, the ball change sequence shall remain as altered. In no case shall new balls be replaced by the old balls after a service game has started.

Re-Warm-Up, Balls

Case: At the end of a game there is a twenty (20) minute rain delay. A ball change was also to occur after that game. When play is resumed, new balls will be in play. What balls are used for the re-warm-up?

Decision: New balls should be used for the re-warm-up. At the end of the warm-up, these balls will be taken away and replaced with new balls to resume the match.

Broken Ball

Case: A ball in play breaks (no compression).

Decision: Replay the point.

Soft Ball

Case: After the point has been completed, the player claims that the point should be replayed because the ball is soft and unplayable.

Decision: The point stands as played. A "soft" ball is not cause for replaying a point even if the Chair Umpire decides that the ball must be replaced.

Case: During a rally, player A catches the ball and wants the point re-played, claiming that the ball is "soft" and unfit for play.

Decision: Player A loses the point. A "soft" ball is not cause for replaying a point. The ball, however, may be taken out of play.

6.04 Crowd Movement / Spectator Seating

A. Regulation

Each ATP Tour tournament shall allow spectators seated above the lowest tier of seats that surround the playing area of the courts to move to and from their seats at any time during play.

- 1) The Tournament Director and the Supervisor will make the designation of the lowest tier at each tournament.

VI. FACILITIES & ON-SITE CONDITIONS

- 2) In cases where there is no clear break in the seating configuration, the Tournament Director and the Supervisor shall determine the most logical designation.

6.05 Security at Tournaments

A. Each tournament has the responsibility to provide adequate security at the tournament site. Players have the responsibility to report any threat or unusual occurrence to the Tournament Director, Supervisor or Senior Vice President - Rules & Competition when at a tournament.

B. The continual use of laptop computers or other handheld electronic devices within the confines (spectator area) of the tournament match courts shall be prohibited and each tournament shall take reasonable steps to enforce such prohibition. The exception to this provision is properly credentialed media, tournament vendors and tournament staff when used in the performance of their duties.

6.06 Equipment & Supplies

A. Placement /Approval

The Supervisor must approve the placement of items or equipment on any court. The Supervisor may remove or have removed any item (including advertising) that may affect the safety of a player, official or ballperson.

B. Chairs

1) Chair Umpire

- a) The sitting platform of the chair for the Chair Umpire must be between six (6) feet (1.83 m.) and eight (8) feet (2.44 m.) high. The seating area should be approximately two (2) feet (.61 m.) wide. The chair shall be centered along the extension of the net approximately three (3) feet (.914 m.) from the net post if the court configuration will accommodate such placement.
- b) The Chair Umpire's and on-court announcer's, if any, microphone must have an "on-off" switch.
- c) Umbrellas are required if the sun is a factor.
- d) Each chair must have a writing platform as specified in "Exhibit X" or as otherwise approved by ATP.
- e) At all outdoor events, the positioning of the umpire's chair shall be on the West side of the court on all courts except for competition court that had the umpire's chair on the East side of the court in 2000 due to infrastructure or other agreed unusual requirements.

2) Line Umpire

- a) Each tournament shall provide chairs for service and base Line Umpires located on an extension of their respective lines along the side fence not closer than twelve (12) feet (3.66 m.) from the doubles sideline. Chairs for sideline and center service Line Umpires should be located next to the back of the court at least twenty-one (21) feet (6.40 m.) behind the baseline. Service and baseline umpire chairs should not be elevated above the surface of the court. The seating area must be a minimum of two (2) feet (.61 m.)
- b) In outdoor events whenever the sun is a factor, Line Umpire chairs shall be positioned so that Line Umpires are not facing the sun unless otherwise ap-

VI. FACILITIES & ON-SITE CONDITIONS

proved by ATP. When the sun is not a factor, the chairs should be positioned on the opposite side of the court from the Chair Umpire.

3) Net Judge

- a) A sponsorship box, which surrounds the net judge chair, may not extend past the net post into the court.
- b) An approved electronic net device can replace the net judge.

4) Player

- a) Each tournament shall provide chairs for the players located on each side of the Chair Umpire. As a guide, the front portion of the player chair/bench should be no closer to the court than the back support/leg of the umpire's chair.
- b) Umbrellas are required if the sun is a factor.

C. Measuring Devices

Each tournament shall provide a measuring stick, tape measure or other measuring device for the measuring of the net height and location of the singles sticks.

D. Net

- 1) The net band shall be cloth, canvas or vinyl, and the net shall extend to the ground, unless otherwise approved by the on-site Supervisor.
- 2) Each tournament shall have spare nets available.
- 3) There can be no commercial or manufacturer identification on the net except as approved by ATP.

E. Net Posts and Net Post Signage. The net posts shall conform to the specifications in the [Rules of Tennis](#), unless otherwise approved by ATP. No signage of any type may be placed on the net posts or net except as determined solely by ATP.

F. Sawdust. Each tournament shall provide sawdust for players on match and practice courts.

G. Scoreboards. Each tournament must provide scoreboards for all courts to be placed at the corner or side of the courts. Placement and color of scoreboards shall not interfere with a player's vision.

H. Towels. Each tournament shall provide towels for players on match and practice courts and in the player's locker room. Towels should be pre-washed and of sufficient size for the intended use.

I. Beverages.

- 1) **Players.** Each tournament shall provide, in sealed containers, electrolyte replacement drinks, non-carbonated bottled water and other beverages for players on-court, in the player's lounges and on the practice courts.
- 2) **Officials.** Each tournament shall provide bottled water and other beverages for Officials on match courts and in the official's off-court area.

VI. FACILITIES & ON-SITE CONDITIONS

6.07 Temperature and Ventilation For Indoor Facilities

Indoor facilities must provide normal and standard heating, cooling and ventilation. The Supervisor may suspend play if, in his judgment, the conditions of play are unacceptable for professional tennis.

6.08 Offices

Each tournament shall provide suitable workspace/office for ATP staff and officials.

6.09 Communication Devices

Each tournament must provide communication devices to the Referee, Chief of Umpires, and Physiotherapist(s) except if otherwise approved by ATP. In addition, the following equipment is required to be on-site:

A. Phones

At a minimum, telephones with local access only are to be provided for the following ATP staff offices: ATP Supervisor, ATP Tour Manager, ATP PR manager and ATP Physiotherapist.

B. Copy machine

A copy machine should be provided in, or near, the Supervisor's office. Copy machine should be available on the morning prior to the start of the qualifying competition.

C. Printer

A printer shall be provided in the office of the Supervisor. Printer should be available on the morning prior to the start of the qualifying competition and be available through the last match of the tournament.

D. Internet

Always-on high speed Internet connection is to be provided in the offices of the ATP Supervisor, ATP Tour Manager, ATP Physiotherapist, ATP scoring system specialist and ATP PR unless otherwise approved by ATP. The required minimum upload and download speeds allocated to ATP staff are 0.6 megabits per second (Mbs) for uploads and 5 Mbs for downloads.

Unless reasonably unable to do so, tournaments shall use web filtering technology to restrict access to internet gambling sites in all areas where tournament provided internet access is available.

E. Live Scoring

Each Tournament shall be responsible for the set up and maintenance of a network based on specifications provided by ATP, to support live scoring services for each match* of the event and subject to 6.09 E, will assist ATP in its efforts to produce and host the live score data generated from each match. Each tournament hereby consents to ATP's non-exclusive use of such live score data and each Tournament

VI. FACILITIES & ON-SITE CONDITIONS

shall not allow or authorize the dissemination, transmission, publication or release from the grounds of the Tournament of any live match score or related statistical data, including without limitation the live score data from the network, by a third party until :30 seconds after the actual occurrence of the incident of match play or action that leads to such live score update (e.g., a point being scored), such delay shall not be applicable to the live audio and/ or visual broadcast or streaming by any method or means (i.e., moving pictures and/or sound/audio reporting of the actual on-court action) and purposes related to such broadcast, of any match (subject to “Exhibit C” – Broadcast Standards set forth herein). Further, each Tournament shall notify ATP in advance of any third party to whom the Tournament has granted access for the purpose of accessing the live score data.

*Tournaments using an alternate venue for main draw matches due to weather or other unforeseen circumstances are encouraged but not required to provide services to support live scoring. Tournaments are not required to provide live scoring support for qualifying matches played at an alternate venue.

F. Live Streaming

Each Challenger tournament shall be responsible for providing and bearing the cost of a secure adequate office space within reasonable distance of the streamed competition courts. In addition, power, including but not limited to an uninterruptible power supply (UPS), shall be made available at no cost to the streaming production partner both in the office space and by the camera positions.

6.10 Tournament Credentialing and Ticketing

A. ATP Membership Card. A 2023 ATP Membership Card shall be honored at all ATP Tour and ATP Challenger Tour events and will permit the holder entry to the tournament office (or such other location as directed by a Tournament or ATP) in order to receive the appropriate credential.

B. General. The following general rules apply with respect to credentialing:

- 1) Players must be accepted into the event to be eligible for a credential.
- 2) Issued player credential badges shall not distinguish between qualifying players and main draw players (for example: qualifying players should not be issued a “Q” badge while main draw players are issued a “P” badge; all players must be issued the same category/type of badge).
- 3) Policies regarding access to practice facilities and locker room for players after they have been eliminated from the event shall be applied equally to both qualifying and main draw players.
- 4) Policies regarding access to amenities (food, transportation, etc.) for players after they have been eliminated from the event shall be applied equally to both qualifying and main draw players.
- 5) In all cases, priority shall be given to players still competing in the event with respect to access to facilities and amenities.
- 6) Player Support Team members must be in the company of a player who is accepted into the event.

VI. FACILITIES & ON-SITE CONDITIONS

7) ATP staff members and ATP Media staff members working on-site at an event shall be provided with a credential with appropriate access upon proper application.

8) All others must have applied in advance and been approved for a credential by the tournament.

9) Special provisions for Combined Events.

- a) **Tour Guests.** One credential for each “official” guest of ATP, provided that such requests are reasonable, and access is limited as appropriate for security.
- b) **Tour Sponsor.** One (1) credential for a “Tour” sponsor.
- c) **Alumni.** Tournaments may provide alumni players credentials at their discretion.
- d) **Tournament Members.** Each tournament shall provide ATP Tournament Directors with on-site access.

C. Applicability. Tournaments must ensure that they have one single accreditation system and policy in place to cover all third party credentials (including, without limitation, credentials for players, player support team members, ATP staff members, suppliers, contractors, media representatives (e.g. photographers, TV crew members, journalists and commentators), Tournament employees and spectators provided with accreditation).

D. Accreditation Policy. Tournaments must base their accreditation policy on the standard “ATP Accreditation Policy” as specified in “Exhibit AC” to create their “Tournament Accreditation Policy”.

E. Application. All persons applying for credentials must have applied in advance and been approved by the Tournament for a credential for the relevant Tournament. Once approved, all persons must sign an “Accreditation Acceptance Form” as provided by the tournament. Tournaments must ensure that the Accreditation Acceptance Form is available in hard copy at the Tournament site, as well as online for those persons applying for credentials through an online system.

F. Proof of Identity. As part of the accreditation process, Tournaments must require proof of identity for all persons prior to issuing credentials; this must be through photo identification such as passport, national ID card or driving license and may be provided in hard copy at the Tournament site or via upload when completing the Accreditation Acceptance Form online.

G. Tournament Credentials. All persons who have successfully applied for accreditation and have signed the Accreditation Acceptance Form shall be issued with a physical credential pass by the Tournament. Tournaments must ensure that such pass must include, without limitation: (i) photo identification (as per Section F above); (ii) the name of the accretee; (iii) a summary of the material points contained in the Tournament Accreditation Policy (including, as a minimum and without limitation, that, unless approved in advance in writing by the ATP, the accretee may not: (a) continually collect, disseminate, transmit, publish or release from the grounds of the Tournament any match scores or related statistical data during match play (from the commencement of a match through its conclusion) for any commercial, betting or gambling purpose; and (b) film, photograph, broadcast, stream, publish, transmit and/or otherwise offer to the public (or assist any third party in offering to the public),

VI. FACILITIES & ON-SITE CONDITIONS

on a live or on a delayed basis, in whole or in part, and whether on a free basis or subject to payment, any sound recording, photograph, video footage, motion picture, film and/or other audio-visual content captured by any means whatsoever inside the Tournament site (except as is allowed in the Tournament Accreditation Policy)); (iv) a web address where the Tournament Accreditation Policy can be found; (v) an Standardized Accreditation Policy Proposal acknowledgement agreeing to abide by the rules of the Tennis Anti-Corruption Program and for players, the Tennis Anti-Doping Program (as amended from time to time); and (vi) an acknowledgement that the accreditation may be revoked at any time.

H. Ticketing. Tournaments must take reasonable steps to enforce the material points of the ATP Accreditation Policy as would apply to ticket holders. Tournaments must ensure that appropriate wording is contained on all tickets provided to ticket holders including, without limitation: (i) a summary, or clear notice directing to a webpage, with the material points contained in the Tournament Accreditation Policy as they apply to ticket holders (including, as a minimum and without limitation, that, unless approved in advance in writing by the ATP, the ticket holder may not: (a) continually collect, disseminate, transmit, publish or release from the grounds of the Tournament any match scores or related statistical data during match play (from the commencement of a match through its conclusion) for any commercial, betting or gambling purpose; and (b) film, photograph, broadcast, stream, publish, transmit and/or otherwise offer to the public (or assist any third party in offering to the public), on a live or on a delayed basis, in whole or in part, and whether on a free basis or subject to payment, any sound recording, photograph, video footage, motion picture, film and/or other audio-visual content captured by any means whatsoever inside the Tournament site (except as is allowed in the Tournament Accreditation Policy)); (ii) a web address where the Tournament Accreditation Policy can be found; and (iii) a notice that the continual use of laptop computers or other handheld electronic devices within the spectator area of the Tournament match courts shall be prohibited.

I. Laptops and Communication Devices. The continual use of laptop computers or other handheld electronic devices within the confines (spectator area) of the tournament match courts shall be prohibited and each tournament shall take reasonable steps to enforce such prohibition. The exception to this provision is properly credentialed media, tournament vendors and tournament staff when used in the performance of their duties.

6.11 Player Benefits - Guest Passes/Credentials/Tickets

A player entered in ATP Tour and ATP Challenger Tour tournaments shall be issued a reasonable number (a minimum of two) guest passes/credentials for his use while competing in the event. Guest passes / credentials shall be issued only after the player guest has provided proof of identity (photo I.D.) and has completed and signed the player guest form. These guest passes/credentials include access to the site, seating in designated areas and other benefits as determined by individual tournaments and shall be valid as long as the player remains at the tournament. Player guest passes/credentials shall not allow access to the player locker room or the Physiotherapist room. All other access is at the sole discretion of the tournament. Passes/credentials can be revoked at any time based on recommendation of the Supervisor to the Tournament Director.

VI. FACILITIES & ON-SITE CONDITIONS

Credentials provided to the player may not be exchanged, directly or indirectly, for money, benefit or anything of value. Violation of this section shall subject the player to the penalties set forth under the Player Major Offense – Aggravated Behavior.

Receipt by any person of guest passes/credentials or any other benefits or special accommodations are expressly subject to the “Limits to On-Site Access” set forth in the Rulebook.

Combined Events.

A. Players. Players shall receive two (2) tickets per day while they are still competing. For ticketed matches, a player box with a minimum of six (6) seats shall be provided for that players' match only. The boxes should be equally located at opposite ends of the court.

B. Staff. Each Tournament must provide the ATP and WTA each three (3) seats close to the entrance of and with easy access to the court during all matches for the following ATP/WTA staff members: (i) Supervisor; (ii) Physiotherapist / PHCP; and (iii) Tour Manager / PR representative.

6.12 ATP Family Lounge and ATP Player Lounge

General. The ATP Family Lounge and ATP Player Lounge (each as defined below) should be secure with only persons with proper access allowed to enter.

Unless reasonably unable to do so, tournaments shall use web filtering technology to restrict access to internet gambling sites in all areas where tournament provided internet access is provided.

Receipt by any person of guest passes/credentials or any other benefits or special accommodations are expressly subject to the “Limits to On-Site Access” set forth in the Rulebook.

ATP Family Lounge. ATP Tour and ATP Challenger Tour tournaments shall provide a suitable space appropriately equipped for the players, their PST members and their properly credentialed guests (“ATP Family Lounge”). Tier 1 Player agents will not count towards the number of PST members allowed and will be granted access to the ATP Family Lounge.

ATP Masters 1000 Family Lounge. ATP Masters 1000 tournaments shall provide (i) complimentary snacks and drinks for players and two (2) PST members per player, and (ii) offer high-speed internet, high-quality coffee, snacks, drinks, juice, smoothie stations, TVs, and games.

ATP 500 Family Lounge. ATP 500 tournaments shall provide complimentary high-speed internet, high-quality coffee, snacks, drinks, juice, and smoothie stations.

ATP 250 Family Lounge. ATP 250 tournaments shall provide for players and two (2) PST members per player complimentary internet, coffee, snacks, and smoothies.

ATP Masters 1000 Tournaments Player Lounge. In addition to the ATP Family Lounge, ATP Masters 1000 tournaments shall also provide a separate quiet room

VI. FACILITIES & ON-SITE CONDITIONS

(“ATP Tour Player Lounge”) with access for the players and one (1) PST member per player.

6.13 Locker Room

A. General. Each tournament shall provide players with a suitably equipped and secure locker room. The entrance to the locker room shall be monitored and only properly credentialed persons shall be allowed to enter. Only those persons with access approval and properly credentialed tournament staff, who in the performance of their duties justify access to the locker room, shall be authorized to enter the locker room.

ATP Masters 1000 and 500 Tournaments. Each tournament shall provide a small seating area for players inside the locker room with a minimum size requirement as determined by ATP dependent on the size of the facility.

B. It is recommended that tournaments located where extreme weather conditions exist provide a submersion bath (ice bath) in or near the shower area. For combined events, if a submersion bath is provided, it must be provided in both locker/shower areas.

C. Lockers

- a) A lockable locker must be available for use by each player.
- b) If the locker requires a separate lock, then this must be provided to each player upon arrival.
- c) If the lockers do not have the ability to be locked; or cannot be locked in a manner that provides reasonable safety, then:
 - i) The tournament must provide separate lock boxes where a player may secure his valuables; or
 - ii) Another method whereas a player may secure his valuables with reasonable expectations of safety must be provided.
- d) For ATP Masters 1000 and 500 tournaments, personal lockers should be able to fit a racket bag inside.

6.14 The Gymnasium (“Gym”)

All ATP Tour events are required to provide a gym as follows:

A. ATP Tour Masters 1000 and 500 events. A fully equipped gym of adequate size must be provided, free of charge, on-site as specified in “Exhibit Z”.

In addition to the on-site required gym, ATP Tour Masters 1000 tournaments shall provide: (i) an additional professional quality level gym (off-site location acceptable in order to provide the requested quality) and (ii) a separate on-site area for player warm-up, light sprints, and movement drills.

In addition to the on-site required gym, ATP 500 tournament shall provide a separate on-site area for player warm-up, light sprints, and movement drills.

B. ATP Tour 250 events. A fully equipped gym, free of charge, of adequate size must be provided on-site as specified in “Exhibit Z”, with the following exception:

If there is a fully equipped gym at the Official Tournament Hotel which is available to all players free of charge, then at a minimum the tournament must provide on-site

VI. FACILITIES & ON-SITE CONDITIONS

a warm-up / cool-down area of adequate size with proper equipment as specified in “Exhibit Z”.

C. ATP Challenger Tour events. A fully equipped gym (as specified in “Exhibit Z”), of adequate size must be provided free of charge on-site, off-site at a reasonable distance from the tournament site/official hotel or at the official tournament hotel with the following exception:

At the Challenger 50-75 category, if it is not reasonably practicable to have a fully equipped gym, then at a minimum the tournament must provide on-site a warm-up / cool-down area of adequate size with equipment as specified in “Exhibit Z”.

Each Challenger tournament regardless of category must provide an area on-site to be used for warm up/cool down, with equipment for this purpose as specified in “Exhibit Z” if fully equipped gym is not available on-site

6.15 Laundry Service

A. ATP Masters 1000 and ATP 500 Tournaments. A complementary laundry service of a high standard must be made available to the players, coaches and ATP/tournament personnel throughout the length of the event, while still competing or working at the event.

B. ATP 250 Tournaments. A complementary laundry service must be made available to the players throughout the length of the event, while still competing or working at the event.

6.16 Stringing Service

A. General. A stringing service of a high professional standard must be made available to the players throughout the length of the event. The machine used for stringing must be an electronic model.

B. Days / Hours of Service.

- 1) At a minimum, stringing service must be available beginning the day prior to the start of the qualifying competition and continue through the last day of the competition, including any carry-over days due to weather or other unavoidable circumstances.
- 2) At a minimum, must be on-site two (2) hours prior to the starting time for the first scheduled match of the day. Must be available continually throughout the day and until the completion of play for that day. For combined events, and recommended for non-combined events, stringing service must be available until thirty (30) minutes after the conclusion of the last match.
- 3) If play is scheduled at an approved alternate site, then access to the stringing service must be provided at such alternate site from the start of play until play has been completed at that site.

C. Fees.

- 1) **ATP Tour Events.** The recommended maximum fee per racquet is \$20 USD / €20 and is the responsibility of the stringing service to collect from the player.

VI. FACILITIES & ON-SITE CONDITIONS

- 2) **ATP Challenger Tour Events.** The recommended maximum fee per racquet is \$12 USD / €12 and is the responsibility of the stringing service to collect from the player.

6.17 Food

General. Each tournament must provide a variety of suitable and of high-quality food for the competitors on-site or, as approved by ATP, within reasonable distance of the tournament venue. Food service should begin no later than the first day of qualifying and continue until the completion of the tournament.

Type of food offered shall be subject to local health and safety regulations.

After a player permanently leaves the event, guest passes/credentials and associated benefits shall be automatically revoked for PST members, unless otherwise decided by the tournament.

See “Exhibit Q” for minimum Player Food Service Guidelines.

ATP Tour Masters 1000 and ATP 500 Tournaments. Each tournament shall provide complimentary food service available for each player and two (2) PST members for the same number of days as the player’s hospitality through direct allocation on the individual credential or allowance on the player credential. Tournaments are encouraged to provide complimentary food for additional PST members.

The complementary food service shall offer fresh, high-quality hot and cold food options with a combination of made to order and buffet food, variety of proteins including vegan protein (tofu or tempeh), carbs, salads, fruit and smoothies.

ATP 250 Tournaments. Each tournament shall provide complimentary food service available for each player and two (2) PST members.

Challenger 125 and 175 Tournaments. Challenger 125 and 175 events shall provide a minimum of one (1) complimentary meal per day (lunch or dinner in addition to breakfast at the hotel) to each player from the starting day of the draw in which he is accepted until the day of the player’s last match in the tournament (singles or doubles).

A. Hours of Service.

At a minimum, from one (1) hour prior to the start of play through a period after the completion of the last match.

B. Safety

- 1) All bottled water and electrolyte drinks must be served in unopened sealed containers.
- 2) All food and beverages must be properly stored and maintained at an appropriate temperature, which complies with local health regulations.

VI. FACILITIES & ON-SITE CONDITIONS

C. Combined Events

- 1) **Working Staff.** Food is to be provided free of charge to all working staff. Visiting staff are not included.

6.19 On-Site Access / Limits to On-Site Access

The ATP CEO, or his designee, may, in his sole discretion, instruct any ATP Tour or ATP Challenger Tour tournament to prohibit any person from obtaining access to any areas at a tournament site that are not generally open or available to all members of the public or from utilizing tournament transportation. The ATP CEO, or his designee may so act for any reason, including without limitation, any concern that the ATP CEO, or his designee may have, in his sole discretion, that such person may pose any issue with respect to security, reputation, integrity, misconduct, or competition.

6.19 Transportation

General. Each tournament must provide scheduled transportation for players (main draw and qualifying), credentialed Player Support Team (“PST”) members, officials and ATP staff that ensures players arrive on-site at least “on the hour”.

ATP Tour Tournaments. The scheduled transportation must meet ATP quality standards and be available from 7AM local time (with advanced booking required for the 7AM local time) through to one hour after the last match/practice session. As a guideline, airport transportation should be available, at a minimum, between 7AM and 10PM local time. PST airport transportation will depend on availability if arriving separately from the player.

Combined Events and Challenger 175. Each Tournament shall provide airport transportation beginning the day before the Qualifying Sign-In Deadline (provided that 24-hour notice is given to the Tournament) until the morning following the final day of the Tournament to:

- All Qualifying and Main Draw players;
- PST members when traveling with a player; and
- ATP and WTA staff working at the Tournament.

6.20 Physiotherapist/Treatment Room

ATP Tour & ATP Challenger Tour

A. General. Each tournament must provide a Physiotherapist/treatment room for players and physiotherapists centrally located to the courts and the locker room. If the Physiotherapist/treatment room is located in an area separate from the locker room, proper security at the entry point must be provided. Only those persons with approved access and properly credentialed tournament staff, who in the performance of their duties justify access to the locker room, shall be authorized to enter the Physiotherapist/treatment room. The room must be private and equipped with ice and ice chests/coolers, towels and electricity. This room must be fully functional by 8:00 am the day prior to the start of qualifying. (For Challengers, the day of main draw). See “Exhibit R “ for full medical facility guidelines.

VI. FACILITIES & ON-SITE CONDITIONS

B. High/Low Treatment/Massage Table.

- 1) **ATP Tour.** Two (2) high/low tables for a 28 or 32 draw event and additional high/low tables for larger draws, as determined by ATP Medical Services.
- 2) **ATP Challenger Tour.** Challenger 125 and 175 events are required to have two (2) high/low treatment tables in the physiotherapist's room, whereas Challenger 100 events are required to have one (1) high/low table in the physiotherapist room with a recommendation to have two (2) high/low tables. A minimum of one (1), but preferably two (2) high/low table(s) is recommended for all other Challenger levels.

C. Recovery Equipment and Facilities.

- 1) **ATP Masters 1000 Tournaments.** Each tournament shall provide: (i) high-quality (selected in consultation with ATP Medical Services) recovery modalities (e.g., compression devices or ice bath) and (ii) separate area with treatment tables (recommendation – 4 for 48-draw; 5 for 56-draw; 6 for 64-draw; and 9 for 96-draw).
- 2) **ATP 500 Tournaments.** Each tournament shall provide: (i) dedicated recovery modalities (selected in consultation with ATP Medical Services) and (ii) separate area with treatment tables (recommendation – 3 for 32-draw and 4 for 48-draw).
- 3) **ATP 250 Tournaments.** Each tournament shall provide: (i) recovery equipment (selected in consultation with ATP Medical Services) and (ii) separate private physiotherapist area with appropriate number of treatment tables.

6.21 Automated External Defibrillator (“AED”)

An Automated External Defibrillator (“AED”) must be provided in the Physiotherapist/treatment room. In addition, AEDs must be located around the site so that an AED is within 2-3 minutes from all areas of play.

For ATP Challenger Tour events it is mandatory for an AED to be located in the Physiotherapist/treatment room and it is highly recommended that a sufficient number of AEDs are located around the site so that an AED is 2-3 minutes from all areas of play

6.22 First Aid

Each tournament must provide a First Aid Team present at all times on the tournament site for public emergencies. The First Aid Team must be separate from the medical team responsible for the care and treatment of the players.

6.23 Anti-Doping Facilities and On-Site Personnel Assistance

A. On-Site Testing Facility

- 1) Each ATP Tour and ATP Challenger Tour tournament, when requested, is obligated to provide at its own cost the following facilities:
 - a) A lockable private room with bathroom and an adjacent waiting room; or, at the discretion of the Anti-Doping Personnel,
 - b) An alternative on-site location with a suitable trailer.

VI. FACILITIES & ON-SITE CONDITIONS

- 2) In addition, the tournament is required to provide at its own cost appropriate furniture, bottled water, fruit and television or court monitoring systems for the testing facility as well as staff assistance for site set-up and facility maintenance during the tournament.

B. Volunteer Observers Provided by Tournament.

Each tournament must provide at its own cost male staff members and/or volunteers who can assist the Official Anti-Doping Personnel and Supervisor with the observation of players selected for testing. The Official Anti-Doping Personnel shall notify a tournament of the number of personnel required no later than three (3) weeks prior to the start of an event.

See “Exhibit V” for full Anti-Doping Facilities Guidelines.

6.24 Media Facilities Guidelines

A. General

All ATP Tour tournaments and the Nitto ATP Finals should provide adequate media facilities. All media areas shall be gambling free zones and any and all persons credentialed for this area, if found to be gambling on tennis or passing insider information to third parties for use in connection with gambling, shall have their credentials revoked. Media credentials must contain a provision whereby the media member acknowledges and agrees that, except as allowed pursuant to Rule 6.09 E, he/she will not disseminate, transmit, publish or release from the grounds of the Tournament any live match score or related live statistical data until :30 seconds after the actual occurrence of the incident of match play or action that leads to such live score update (e.g., a point being scored), and that such use shall be solely for news reporting and editorial use.

B. Media Work Room

- 1) **Location.** The media work room should be located as near as possible to the player locker room (and for ATP Masters 1000 and ATP 500 tournaments near the ATP Family Lounge).
- 2) **Security.** Media work room must be secured with access provided only to properly credentialed media, players and other tournament and ATP Staff when in the performance of their duties.
- 3) **Specifications.** Requirements / recommendations for the media work room can be found in “Exhibit S - Media Facilities Guidelines”.

C. Player Interview Rooms

- 1) **Location.** Should be located near both the player locker room and the media work room.
- 2) **Specifications.**
 - a) Must be “smoke free”.
 - b) Sound proof
 - c) Interview room must be secured with access provided only to properly credentialed media, players and other tournament and ATP Staff when in the performance of their duties.

VI. FACILITIES & ON-SITE CONDITIONS

- d) Interview backdrop shall comply with all branding requirements of ATP.
- e) Space to be provided for journalists, photographers and television personnel.

- 3) **Small Interview Rooms.** ATP Masters 1000 and ATP 500 tournaments shall provide the following number of small private interview rooms: (i) 96-draw: 3, and (ii) 56-draw and 48-draw: 2.
- 4) **Transcripts.** ATP Masters 1000 and ATP 500 tournaments shall provide transcripts for all interviews.

D. Mixed Zone

- 1) **Location.** The Mixed Zone shall be in a suitable location, as determined by ATP, on the player route as close as possible to the player locker room and media work room.
- 2) **Branding.** The Mixed Zone shall be branded as stated under the rules for Media Backdrop (“Exhibit A.11”).

Unless reasonably unable to do so, tournaments shall use web filtering technology to restrict access to internet gambling sites in all areas where tournament provided internet access is provided.

See “EXHIBIT S” for full Media Facilities Guidelines.

- E. **TV Studios.** ATP Tour Masters 1000 tournament shall provide the following number of TV studios: (i) 96-draw – 3, and (ii) 56-draw and 48-draw: 2.

- F. **Stars Program.** ATP Tour Masters 1000 tournaments must provide a dedicated person to help implement the Stars Program.

6.25 Electronic Line Calling Facilities Guidelines

The use of an approved electronic system for reviewing line calls and/or overrules is authorized for use at ATP events.

See “Exhibit T - Electronic Line Calling Facilities Guidelines” and “Exhibit U - ELC Review Official Protocol” for full Electronic Line Calling Facilities Guidelines and Protocol.

VII. THE COMPETITION

7.01 ATP Fees

A. Entry Fees

- 1) **ATP Tour Tournaments.** There are no entry fees.
- 2) **ATP Challenger Tour Tournaments.** There are no entry fees.

B. Service Fee

- 1) Players who are included in the main draw or qualifying (singles or doubles) of any ATP Tour tournament and who are not members in good standing with ATP must pay the following service fee to ATP:

ATP Tour Masters 1000	Main Draw \$400/€400 event	Qualifying \$100/€100
United Cup	\$350	
ATP Tour 500	Main Draw \$300/€300 event	Qualifying \$100/€100
ATP Tour 250	Main Draw \$200/€200 event	Qualifying \$100/€100

- 2) The Tour Manager will identify players who must pay a service fee that will be withheld from on-site prize money. Players who by virtue of their ranking position are not eligible for an ATP player membership may use these payments as a credit toward future membership fees. Service fees paid to ATP may only be applied against membership dues in the calendar year in which they were paid.

C. Membership Fees

Membership fees are defined in the ATP By-Laws.

7.02 Entries

A. Gender / Age Limitation

ATP will use the age of a player on the first (1st) day of the qualifying competition. Male players age sixteen (16) or older are not limited in the number of tournaments they may enter. Players under the age of sixteen (16) are subject to the following entry restrictions in ATP Tour or ATP Challenger Tour tournaments (includes entry as a wildcard):

- 1) Male players under the age of fourteen (14) shall not be eligible for entry into any ATP Tour or ATP Challenger Tour tournament.
- 2) Male players aged fourteen (14) shall be eligible for entry into a maximum of eight (8) ATP Tour or ATP Challenger Tour tournaments.
- 3) Male players aged fifteen (15) shall be eligible for entry into a maximum of twelve (12) ATP Tour and ATP Challenger Tour tournaments.
- 4) **Transgender Athlete Participation.** A trans male (FTM) athlete who has received a medical exception for treatment with testosterone* for diagnosed Gender Identity Disorder or gender dysphoria and/or Transsexualism, for purposes of competition may compete on the ATP Tour or ATP Challenger Tour. A trans male (FTM) athlete who is not taking testosterone related to gender transition may also participate in ATP Tour or ATP Challenger Tour events.

*Must have a valid TUE from the Tennis Anti-Doping Program.

VII. THE COMPETITION

7.03 Entry Deadlines

A. Main Draw/Qualifying Singles

The deadline for entries and withdrawals for the singles main draw is as follows:

- 1) ATP Tour Tournaments.** 12 Noon, Eastern Time, USA, twenty-eight (28) days prior to the Monday of the tournament week (or the first tournament week in the case of tournaments scheduled for more than one (1) week). A player on the alternate list for the singles main draw may withdraw at any time prior to such time that he is moved into the main draw as a direct acceptance because of withdrawals of other players. A player who moves in from the alternate list will be considered a Direct Acceptance from Thursday, 10 AM Eastern Time, USA.
- 2) ATP Tour Qualifying.** 12 Noon, Eastern Time, USA, twenty-one (21) days prior to the first Monday of the tournament week. A player on the Alternate List for the singles qualifying may withdraw at any time prior to such time that he is moved into the qualifying as a Direct Acceptance from Thursday, 10 AM Eastern Time, USA. A player directly accepted into the qualifying competition may withdraw, without penalty, if he is moved into the main draw, or accepts a wild card into an ATP Tour 250 or ATP Tour 500 tournament, or if he is still competing in an ATP Tour, ATP Challenger Tour, or ITF Men's WTT tournament at any time on the day prior to the commencement of qualifying or two days prior if competing on another continent. If a player is still competing past 9:00 p.m. local time, he will be automatically withdrawn from the qualifying without penalty. Players who withdraw or are withdrawn due to "still competing" will be allowed to accept a wild card or enter doubles into any ATP Tour 250, ATP Tour 500, ATP Challenger Tour or ITF Men's WTT tournament, including qualifying. If a withdrawal occurs prior to 10 AM, Eastern Time, USA, on Friday, the qualifying vacancy shall be filled by the next player on the qualifying alternate list. This player is not required to sign in. If a withdrawal occurs after 10 AM, Eastern Time, USA, on Friday, the qualifying vacancy will be filled from the on-site sign-in list, using the most recent Pepperstone ATP Rankings list. Main draw vacancies will be filled from the main draw alternate list, not the qualifying acceptance list.

NOTE: For ATP Tour qualifying tournaments, withdrawals occurring after 10 AM Eastern Time USA and prior to the draw* will be filled from that night's alternate sign-in. Vacancies occurring after the release of the qualifying draw, will be filled from the next day's on-site alternate list. Players must personally sign-in to be eligible as an on-site alternate.

* For events in a time zone where the qualifying draw is made prior to 10 AM Friday, Eastern USA, vacancies occurring after the Qualifying Alternate sign-in deadline but prior to the qualifying draw shall be filled from that night's alternate sign-in.

May I Accept a Wild Card after Withdrawing from an ATP Tour Qualifying?

Case: A player was still competing in a Challenger on the day before Qs started at an ATP Tour event. He wanted to withdraw from the Qs due to "still competing" and then take a wild card into a Challenger event. Is this allowed?

Decision: Yes. The rule states that he may withdraw without penalty from the qualifying if he is still competing on the day prior to the commencement of the qualifying. By withdrawing due to "still competing", he is allowed to accept a wild card.

VII. THE COMPETITION

Case: Can a player who is still competing the previous week on Thursday or Friday (on the same continent*), or on Wednesday (on a different continent*) be signed in over the phone as a Qualifying Alternate for the following week's event (Saturday Qualifying start)?

Decision: Yes, a player who is still competing the previous week on Thursday or Friday (on the same continent*), or on Wednesday (on a different continent*) can be signed in by the Supervisor over the phone if he has lost before the Qualifying Alternate sign-in deadline. Players who lose after the release of the qualifying draw must personally sign-in on-site the next day to be eligible as an on-site alternate.

*Continents are: Europe, Asia, Antarctica, Australia, Africa, North America (including Central America) and South America.

Case: If a player is competing in an event (including Davis Cup) that finishes on the day of the Qualifying Alternate sign-in for the following week's event, can he be signed in as a Qualifying Alternate, even though he may be competing past the Qualifying Alternate sign-in deadline?

Decision: Yes. Since the event finishes on the day of the Qualifying sign-in deadline, the player may be signed in as a Qualifying Alternate for the following week's event.

From Q to Main Draw of another event

Case: May a player who is a direct acceptance to an ATP Tour qualifying event be withdrawn to move into the main draw of an ATP Tour 250 or ATP Tour 500 event as a Direct Acceptance or Wild Card which is held in the same week?

Decision: Yes, as long as the first ball of the qualifying at the tournament where he is in the qualifying draw has not been struck.

Case: May a player withdraw BDA from the main draw alternate list of an ATP Tour Event and remain on and/or play the Qualifying of the same event?

Decision: Yes, unless he would have moved into the main draw of that event, had he not withdrawn. A player may not turn down this main draw position to play the qualifying of that event.

Case: May a player who is accepted to play qualifying in an ATP Challenger Tour Tournament, ATP Tour 250 or ATP Tour 500 be withdrawn to move into the main draw singles of an ATP Tour 250 or ATP Tour 500 event as a Direct Acceptance or as a Wild Card which is held the same week?

Decision: Yes, as long as the first ball of the qualifying at the tournament where he is in the qualifying draw has not been struck.

Withdrawing from Qualifying to play Main Draw Doubles at another event.

Case: May a player who is direct acceptance in the singles qualifying event of an ATP Tour 250 or ATP Tour 500 enter through the Advance Entry system and become a direct acceptance into the main draw doubles of another ATP Tour 250 or ATP Tour 500 event which is held the same week?

Decision: No. Once a player enters and is accepted into the Qualifying of an ATP Tour Tournament, he is committed to that

VII. THE COMPETITION

tournament unless he moves into the main draw singles of another ATP Tour event. However, a player who competes and loses in the singles qualifying competition may enter the doubles event of any tournament, provided he has lost prior to the respective tournament's on-site doubles sign-in deadline.

Withdrawing from Qualifying to play Main Draw Doubles at the same event.

Case: *May a player who is included in the singles qualifying event of an ATP Challenger Tour Tournament, ATP Tour 250 or ATP Tour 500 and is forced to withdraw, be allowed to come back and play doubles at the same event?*

Decision: Yes

- 3) **ATP Challenger Tour Tournaments.** 12 Noon, Eastern Time, USA, twenty-one (21) days prior to the Monday of the tournament week. A player on the Alternate List for the singles main draw may withdraw at any time prior to such time that he is moved into the main draw as a direct acceptance because of withdrawals of other players. A player who moves in from the alternate list will be considered a Direct Acceptance from Thursday, 10 AM Eastern Time, USA.

If a withdrawal/vacancy occurs after the withdrawal deadline and prior to the start of Qualifying, the vacancy will be filled in ranking order from the original main draw Acceptance List by players who have preserved their position on the list. Players from the main draw alternate list who are directly accepted into the qualifying, are considered to have preserved their eligibility. A player can only preserve his eligibility on one list. If there are no alternates from the original main draw acceptance list who have preserved eligibility, the vacancy will be filled by the highest ranked player from the qualifying or alternate list using the Pepperstone ATP Rankings, and then Pepperstone ATP Doubles Rankings, used for seeding.

After the start of the qualifying, any vacancy will come from the Lucky Loser/ Alternate list. The Alternates will be placed below the players who lost in qualifying and shall be ordered based upon their position in the Pepperstone ATP Rankings, and then the Pepperstone ATP Doubles Rankings, used for seeding.

NOTE: In order to preserve his eligibility on the Acceptance List, the player must email the ATP Supervisor directly prior to 6PM local time on the day before qualifying starts (email listed on detail sheet) and personally inform the Supervisor that he wishes to preserve his position on the Acceptance List and the player must leave a contact number. The player should ask for confirmation that the Supervisor has received the email in a timely manner. A player can only preserve his eligibility on one list.

- 4) **ATP Challenger Tour Qualifying.**

12 Noon, Eastern Time, USA, on Wednesday, nineteen (19) days prior to the first Monday of the tournament week for ATP Challenger Tour. A player on the Alternate List for the singles qualifying may withdraw at any time prior to such time that he is moved into the qualifying as a Direct Acceptance because of withdrawals of other players. A player who moves in from the alternate list will be considered a Direct Acceptance from Thursday, 10 AM Eastern Time, USA. A player directly accepted into the qualifying competition may withdraw, without penalty, if he is moved into the main draw, or accepts a wild card into a Challenger, ATP Tour 250 or ATP Tour 500 tournament, or if he is still competing in an ATP Tour, ATP Challenger Tour, or ITF Men's WTT tournament at any time on the day prior to the

VII. THE COMPETITION

commencement of qualifying or two days prior if competing on another continent. If a player is still competing past 9:00 p.m. local time, he will be automatically withdrawn from the qualifying without penalty. Players who withdraw or are withdrawn due to "still competing" will be allowed to accept a wild card or enter doubles into any ATP Tour 250, ATP Tour 500, ATP Challenger Tour or ITF Men's WTT tournament, including qualifying. If a withdrawal occurs prior to 10 AM, Eastern Time, USA, on Friday, the qualifying vacancy shall be filled by the next player on the qualifying alternate list. This player is not required to sign in. If a withdrawal occurs after 10 AM, Eastern Time, USA, on Friday, the qualifying vacancy will be filled from the on-site sign-in list, using the most recent Pepperstone ATP Rankings list.

NOTE: For the purposes of this rule, the Continents are: Europe, Asia, Antarctica, Australia, Africa, North America (including Central America) and South America.

Sunday Start for Qualifying

Case: *The qualifying event begins on Sunday, how does this effect players being signed in coming from the previous week's event?*

Decision: *The criteria for signing players in from other events is adjusted by one day, i.e. a player losing on Thursday on a different continent is eligible to be signed in when the next event's qualifying begins on Sunday. Players competing on Saturday in the previous week's event must have lost prior to the qualifying sign-in deadline at the next event, plus they must be able to arrive at the qualifying event to play as scheduled.*

Time. The ATP Challenger Alternate Sign-in shall begin no later than 4 p.m. and close at 6 p.m. local time on the day prior to the start of the qualifying competition. There shall also be an Alternate sign-in on the day of first round qualifying play, this deadline is one-half hour prior to the first scheduled qualifying match. This is a new sign-in and any player who is on-site with a Pepperstone ATP Ranking (singles/doubles) is eligible to sign-in.

Case: *Can a player who is a direct acceptance in the qualifying of a Challenger tournament, preserve his eligibility at another Challenger tournament?*

Decision: *No. A player is considered to have preserved his eligibility only at the tournament where he is a Direct Acceptance into qualifying. He cannot withdraw and preserve eligibility at another event unless the withdrawal was for "still competing". However, he can withdraw and preserve his eligibility at the same event where he was a Direct Acceptance into qualifying.*

- 5) If a tournament date, site or surface is changed; it is the player's responsibility to withdraw from the event on or before the new entry/withdrawal deadline if he does not wish to play.

- 6) **Late Entries.**

Any player who submits an entry after the deadline may only be accepted into the singles main draw as a wild card, qualifier, or as a special exempt (if eligible).

- 7) **Emergency Situations.**

ATP Tour 250 Events

- a) Tournaments shall qualify for one (1) emergency substitution if the following conditions exist:

VII. THE COMPETITION

- i) Two (2) of the tournament's top four (4) seeds withdraw; and
- ii) One (1) of the withdrawals involves the first or second seeded player; and
- iii) The substitute player (1) will become one of the tournament's top two (2) seeds*.

The withdrawals and substitution must occur within the period beginning on the Monday prior to the start of the event week and ending at 10 AM, Eastern Time, USA, on the Friday before the event week, or if the second withdrawal occurs between 9:00 AM and 10 AM, Eastern Time, USA on the Friday before the event the deadline for naming a qualified substitute shall be extended by one (1) hour. During this one hour period all lists will be held awaiting a final cut-off for the affected event. If no substitution is made within this defined time period, then the next player on the acceptance list shall be moved into the main draw.

- b) The tournament shall pay prize money equal to that paid first-round losers to each player who would have been a direct acceptance if not for the late substitution. This payment shall not apply in the case where the player gained entry into a main draw singles, at any event, by other means.

*For purposes of determining if the substitute player qualifies as a 1 or 2 seed, all players including Wild Cards, shall be ranked in order using the most recent Pepperstone ATP Rankings. To be eligible for the emergency substitution, the tournament must have declared their Wild Cards to the ATP prior to the withdrawal of the player that qualified them for the emergency substitution.

CASE: Which Pepperstone ATP Ranking is used to determine the emergency substitution rule?

DECISION: The most recent Pepperstone ATP Rankings is used to determine the seeding of the withdrawing players as well as the seeding of the substitute player.

CASE: If a Wild Card player will become one of the tournament's top two seeds, can a tournament switch the Wild Card to a substitute player if the Wild Card was announced?

DECISION: No, once the Wild Card has been announced, such player is not eligible to become a substitute player.

B. Main Draw Doubles

1) ATP Tour Tournaments

- a) **Advance Entry.** 12 Noon, Eastern Time, USA, fourteen (14) days prior to the Monday of the tournament week (or the first tournament week in the case of tournaments scheduled for more than one (1) week). A team on the alternate list for the doubles main draw may withdraw at any time prior to such time that they are moved into the main draw as a direct acceptance because of withdrawals of other teams.
- b) **Withdrawal Deadline.** The deadline for a team to withdraw from the advanced entry list closes at 10 AM, Eastern Time, USA, on the Friday prior to the tournament week.
- c) **On-site Entry.** The period for online on-site entries opens at 12:01 am, Eastern Time, USA on the Friday prior to the tournament week and closes at 3:00 pm Eastern Time, USA on the Friday prior to the tournament week. The online sign-in is blind and no preliminary lists will be produced. Players entering multiple events in the same week must do so with the same partner and shall designate tournaments by priority. The on-site entry process will populate an

VII. THE COMPETITION

Alternate List for vacancies occurring after the tournament withdrawal deadline and prior to the doubles draw being made.

2) ATP Challenger Tour Tournaments

- a) **Advance Entry.** 12 Noon, Eastern Time, USA, seven (7) days prior to the Monday of the tournament week unless otherwise authorized by ATP. Players entering multiple events in the same week must do so with the same partner and shall designate tournaments by priority.
 - b) **Withdrawal Deadline.** The deadline for a team to withdraw from the advanced entry list closes at 10 AM, Eastern Time, USA, on the Friday prior to the tournament week.
 - c) **On-site Entry.** The on-site sign-in deadline for doubles shall be 12 Noon local time on the Saturday prior to the first day of the tournament unless otherwise authorized by ATP. The number of places available through the on-site entry is specified in the Composition of Draws (7.08 D. 3)) plus any spots made available through withdrawals occurring after the advance doubles entry deadline. Teams who did not enter through the on-site sign-in and teams where one member of the team is eligible to re-pair following the withdrawal of his partner are eligible* to sign the daily alternate sign-in and are placed below those teams on the alternate list who did enter through the on-site sign-in method.
*To be eligible, alternate teams who did not enter through the on-site protocol must sign-in on the first day of the doubles competition.
- 3) The doubles sign-in record shall be available for player sign-in at a reasonable time prior to the sign-in deadline.

C. Qualifying Doubles

1) ATP Tour 500

The size of the draw is four (4) with two (2) seeds. The composition of the doubles qualifying draw will be the first three (3) teams from the entry list plus one (1) wild card team. All matches will be played as two tie-break sets, no-ad scoring with a match tie-break at one set all. Qualifying matches are to be held on the Saturday / Sunday prior to the start of main draw, as determined by the Supervisor and Tour Manager. Teams shall receive hospitality. Rooms for doubles qualifying players shall be available beginning on Saturday and continue through the night of their last match.

Points. The qualifying team shall receive 45 ranking points. The team losing in the final round of qualifying shall receive 25 ranking points*.

*Teams receiving a first round Bye and subsequently losing in the final round receive no points.

2) ATP Challenger Tour Tournaments

There is no doubles qualifying at ATP Challenger tour events.

D. Entry Deadline Extensions

ATP may extend the deadline for entries and/or withdrawals when unforeseen circumstances arise.

VII. THE COMPETITION

7.04 Entry/Withdrawal Method

A player may enter a Grand Slam, ATP Tour or ATP Challenger Tour tournament through a written entry form or other alternatives available to ATP player members. For entry into an ATP Tour or ATP Challenger Tour main draw or qualifying singles and doubles, the player must be an ATP Player Member or an ATP Registered Player. Wild Cards are exempt from this provision.

Junior Accelerator Spots (JAS)

Junior Accelerator Spots are awarded at the Challenger level to the Junior players who are ranked 1-20 in the year-end ITF Junior Rankings, Singles Junior Grand Slam Champions, and Finalists.

• **Challengers 50 and 75** - Junior Accelerator Spot can be awarded to up to two (2) players in every Main Draw (eligible Junior players ranked 1-10 and Junior Grand Slam Champions) and to up to two (2) players in every Qualifying (eligible Junior players ranked 11-20 and Singles Junior Grand Slam Finalists) of Challenger 50 and 75 tournaments.

Each Junior player ranked 1-10 and Junior Grand Slam Champion shall be eligible for up to eight (8) total Main Draw opportunities, with a maximum of four (4) uses per six (6) months. Each player ranked 11-20 and Junior Grand Slam Finalist shall be eligible for up to eight (8) total Qualifying opportunities, with a maximum of four (4) uses per six (6) months.

• **All Challengers** – Players who are eligible for the Challenger Junior Accelerator Spots (i.e. ranked 1-20) can be promoted via Promotion System from Qualifying to Main Draw at any Challenger tournament (i.e. up to 2 spots reserved per tournament) if they are directly accepted into the Qualifying with their ATP Ranking at the entry deadline, subject to availability.

Any Junior Accelerator Spot or Promotions from Qualifying to Main draw will be determined at the relevant Challenger Main Draw of Qualifying Entry Deadline.

A. Main Draw - Singles

1) No player shall be considered entered or withdrawn from an *ATP Tour Masters 1000, ATP Tour 500**, ATP Tour 250 or ATP Challenger Tour tournament unless his written entry or written withdrawal is received on or before the entry or withdrawal deadline by a player relations staff member, ATP Supervisor or through the PlayerZone. A player must have entered in order to be moved into the main draw as a direct acceptance because of the withdrawals of other players. For each ATP Tour Masters 1000 tournament, players with a Pepperstone ATP Rankings position that qualifies them as a direct acceptance or alternate, shall be automatically entered by ATP.

* For the mandatory ATP Tour Masters 1000 tournaments, this section is applicable for withdrawals only as entries are automatic. If a withdrawal is made prior to the Acceptance List being published, any player directly accepted as a result of that withdrawal will be considered a Direct Acceptance once the list is published.

** Commitment players are automatically accepted into the main draw of all ATP Tour 500 events in which they have entered in a proper manner.

VII. THE COMPETITION

- 2) Once a player enters he is subject to all the withdrawal provisions.
- 3) Withdrawals, retirements or defaults during an ATP Tour or ATP Challenger Tour tournament must be made through the Supervisor.

B. Main Draw - Doubles

1) Advance Entry – ATP Tour Only

- a) No team shall be considered entered or withdrawn from an ATP Tour tournament* unless their written entry or written withdrawal is received on or before the entry or withdrawal deadline by a player relations staff member or ATP Supervisor. A team must have entered in order to be moved into the main draw as a direct acceptance because of the withdrawals of other players.
- b) Once a team enters they are subject to all the withdrawal provisions.

*The top 13 eligible teams from the final 2022 ATP Doubles Team Rankings shall receive automatic Direct Acceptance into the first 5 Masters 1000 events in the 2023 season (if not included as a Direct Acceptance on their own merit). To qualify for automatic acceptance a team must have competed as a team in 11 ATP Tour or Grand Slam events during the 2022 season. A player can only be eligible on one team.

For each of the remaining four (4) Masters 1000 events, the top 13 eligible teams in the Team Race at the advanced entry deadline for that event, shall receive automatic Direct Acceptance into that Masters 1000 event (if not included as a Direct Acceptance on their own merit). A player can only be eligible on one team.

To qualify for automatic acceptance into the first 5 Masters 1000 events a team must have competed together as a team in each week of the 2023 season where both players were playing doubles in that week. The exception would be when they were both involved in the singles of different events.

To qualify for automatic acceptance into the final 4 Masters 1000 events, a team must compete together as a team in each week of the 2023 season where both players were playing doubles in that week. The exception would be when they were both involved in the singles of different events.

2) On-Site Entry - ATP Tour - See 7.03 B. 1) c)

On-Site Entry - ATP Challenger Tour Tournaments

- a) No team shall be accepted for on-site entry into the doubles event unless one player of the team personally signs the on-site entry list unless subsection d) applies.
- b) If neither player of the team is able to sign the list then such team may enter the doubles event by submitting a written entry to ATP or by personally contacting the Tour Manager or Supervisor at the tournament he wants to play.
- c) Written entries submitted by a player(s) who is not on-site and who has not been able to talk to the Tour Manager or Supervisor, must be received by the on-site Supervisor prior to the deadline.
- d) The Tour Manager or Supervisor may sign-in and enter doubles teams.
- e) Each member of a team wishing to enter the doubles event must be either an ATP Player Member or an ATP Registered Player.

VII. THE COMPETITION

Emailed Doubles Entry

Case: The Supervisor/Referee is sent a doubles entry via email. The email was not seen by the Supervisor/Referee until after the entry deadline. The date/time of the email show that it was received prior to the deadline. Is this a valid entry?

Decision: No. To be considered as a valid entry the official at the site of the doubles event (Supervisor, Referee or Tour Manager) must have actually viewed the email. The same decision would be made on undelivered faxes or an entry left on voice mail.

Note: Proper procedure for any emailed or faxed entries would be to ask for a confirmation from the person who the entry was sent. Barring confirmation, you should make personal contact prior to the entry deadline.

C. Qualifying

Players may be entered in the main draw (singles or doubles) as qualifiers based on their success in the respective qualifying competition.

- 1) **Challenger.** The ATP Challenger Alternate Sign-in shall begin no later than 4 p.m. and close at 6 p.m. local time on the day prior to the start of the qualifying competition. There shall also be an Alternate sign-in on the day of first round qualifying play, this deadline is one-half hour prior to the start of play on the day of the qualifying competition.
- 2) **ATP Tour.**
 - a) Direct acceptances to ATP Tour qualifying are not required to sign-in.
 - b) The ATP Tour Qualifying Alternate sign-in shall begin no later than 4 p.m. and close at 6 p.m. local time on the night prior to the start of the qualifying competition (Friday night for a qualifying commencing on Saturday).
- 3) **Challenger & ATP Tour.** There shall also be an Alternate sign-in on the day of first round qualifying play, this deadline is one-half hour prior to the first scheduled qualifying match. This is a new sign-in and any player who is on-site and with a Pepperstone ATP Ranking (singles or doubles) is eligible to sign-in.

Can I Play Both?

Case: A player is playing a doubles match on the Friday night before a Saturday start to Qualifying that will not finish before 9 p.m. local time at the following week's tournament. The next tournament is 2-3 hours traveling time and because the doubles semi-finals is scheduled for Saturday night, it is feasible for the player to drive between the two locations so that he could compete in the qualifying singles and still play the doubles semi-final should he win on Friday night. Can he remain a direct acceptance?

Decision: Yes. The Saturday night doubles match (which cannot be a result of special scheduling) makes this possible for the player. Appropriate penalties apply if the player does not appear for his qualifying match or his doubles semi-final match, if he wins Friday night.

Players Miss Sign-In

Case: Players cannot be at the Lucky Loser/Alternate sign-in on time because of circumstances beyond their control. If the Supervi-

VII. THE COMPETITION

sor is satisfied that the players were not at fault, may he sign them in?

Decision: No.

D. Sign-in Protocol:

All sign-ins (doubles, qualifying, alternates, lucky losers) must be done by phone via text messaging. Each entry must be received and viewed by the on-site supervisor, or the designate listed on the official detail sheet, prior to the deadline. The player is responsible for having his entry confirmed by the supervisor or the designate listed on the official detail sheet.

7.05 Withdrawal/Late Withdrawal Penalties

The following shall result when a player withdraws after the deadline from the singles main draw of an ATP Tour or ATP Challenger Tour tournament:

- A. A player shall be subject to the sanctions provided in the Player Code of Conduct.
- B. If the withdrawal is from the singles main draw of an ATP Tour tournament, the player shall be required to fulfill his obligations under the ATP Stars Program.
- C. If the withdrawal occurs after 10 AM, Eastern Time, USA, on Friday before the tournament week or, in the case of doubles, after the on-site entry deadline, then the withdrawal shall be considered a late withdrawal and shall also result in a late withdrawal fine, unless the injury on-site examination provisions or player promotional activity provisions apply as stated under repeal of penalties. In addition, in the case of a 96-draw tournament, if the withdrawal occurs after the qualifying or main draw is made, whichever comes first, the player shall receive a late withdrawal fine, unless the injury on-site examination or player promotional activity provisions apply. Players included in the draw that fail to appear on-site shall be classified as a late withdrawal.

Whom To Fine?

Case: Player A and player B agree to play doubles together in a tournament, so player B signs the team in to play. On Monday, player A withdraws from singles and consequently from doubles. As player A does not come on-site for promotional activities, he is aware that he will get a withdrawal penalty for singles. What penalties apply to the doubles team?

Decision: Player A gets a fine for doubles while player B does not as he is on-site.

D. No Play After Withdrawal

- 1) If a player withdraws after the entry/withdrawal deadline from the singles or doubles event of a Grand Slam, ATP Tour, ATP Challenger Tour or the qualifying competition of an ATP Tour/Challenger Tour tournament for any reason, he may not play in any other tournament or special event during that tournament week.
- 2) If the withdrawal was for medical reasons then the player may enter and compete in the doubles event of the same tournament provided he is determined by the Supervisor, upon written medical advice, to be physically capable to compete on a professional level of play.

VII. THE COMPETITION

- 3) No player may continue playing in an ATP Tour or ATP Challenger Tour tournament in singles or doubles after giving notice of withdrawal from a tournament scheduled in a future week on account of injury, illness or other medical reason. Players, however, may continue playing in that event if the withdrawal from the future event was for non-medical reasons.
- 4) **ATP TOUR:** The exception to No Play after Withdrawal is the withdrawal of a team accepted into the main draw of an ATP Tour tournament through the advance entry method due to one or both team members being accepted into the main draw singles of another ATP Tour, ATP Tour Qualifying or ATP Challenger Tour tournament. In this case, both players may enter a doubles competition, together or separately, through the on-site entry method.
- ATP CHALLENGER TOUR:** The exception to No Play after Withdrawal is the withdrawal of a team accepted into the main draw of an ATP Challenger Tour tournament through the advance entry method due to one or both team members being accepted into the main draw singles of another ATP Tour, ATP Tour Qualifying, ATP Challenger Tour tournament, ATP Challenger Tour Qualifying or ITF WTT M25 or M15 main draw or qualifying tournament. In this case, both players may enter a doubles competition, together or separately, through the on-site entry method.
- 5) A violation of this section shall also be punishable by the provisions set forth in the Code of Conduct.

Case: A player is a Direct Acceptance in a Grand Slam or Masters 1000 96-draw tournament and withdraws. Can he play an ATP Challenger during the 2nd week of that tournament.

Decision: Yes as long as the withdrawal was prior to the start of qualifying.

Case: A player is an alternate on an ATP Tour Qualifying list and gets in and is inserted in the draw which is done before the official withdrawal deadline due to the difference in time zones. Is he allowed to withdraw once he is in the draw and play somewhere else?

Decision: When the player gets in the draw, he is automatically withdrawn from any other qualifying event where he was an alternate. He will be allowed to withdraw (up until the Thursday, 10 AM commitment deadline) from the event where he got in and not be penalized. However, he will only be allowed to play doubles at the same event.

Case: May a player withdraw from a tournament where he is a Direct Acceptance in singles or doubles (with his regular or protected ranking) and then accept a wild card into the same tournament?

Decision: Yes, provided the withdrawal is prior to the withdrawal deadline, a player may withdraw from a tournament and then accept a wild card into the same tournament. For doubles, the wild card must be with his original partner. He cannot accept a wild card nor play in any other tournament or event in the same week as the tournament he withdrew from. (Tour Policy)

Case: A player accepted in an ATP Tour, ATP Challenger Tour main draw or ATP Tour Qualifying list using a PR withdraws prior to the withdrawal deadline and accepts a WC into the same event. Does

VII. THE COMPETITION

this tournament count towards the total tournaments at which the player can use his PR?

Decision: No, this tournament will not count towards the player's total of tournaments.

Case: A player withdraws from an ATP Tour tournament prior to the Friday, 10 AM deadline with injury. He is allowed to play doubles in the same event provided he is determined to be physically capable to compete. Since he is coming on-site to play doubles, does he have to do promotional activity?

Decision: No, however, he is required to complete his Stars requirements if requested by ATP staff.

Case: May a player withdraw BDA from the main draw alternate list of an ATP Tour or Challenger event and play the Qualifying of the same event?

Decision: Yes, unless he would have moved into the main draw of that event, had he not withdrawn. A player may not turn down this main draw position to play the qualifying of that event. He may, however, play the Qualifying of a different event.

Challenger Cancels, Where can I Play?

Case: A player enters and is main draw of a Challenger on the original Acceptance List. The Challenger cancels. The deadline has now passed for entering another Challenger or 250 tournament during the same week. What are the player's options for competing that week?

Decision: The player may sign in as an Alternate at any ATP Tour or ATP Challenger Tour qualifying event the same week. Or he may accept, if offered, a Wild Card at any Challenger or ATP Tour event. He may not be inserted directly into the draw or placed on another Acceptance List.

Options if Tournament Changes Surface after the Entry Deadline

Case: Can a player withdraw from the main draw and play elsewhere during the same week if a tournament changes its surface after the Acceptance List has come out?

Decision: The player may sign in for Qualifying at any event that week or he may accept, if offered, a Wild Card at any Challenger or ATP Tour event. He may not be inserted directly into the draw or placed on another Acceptance List.

Case: A doubles team enters 4 Challenger tournaments in the same week through phone or email. The team is accepted and appears on two draws at the same time as well as the alternate lists of the other 2 tournaments. Is the team allowed to withdraw from one of the events it is accepted into and play at the other one?

Decision: No. The team is in violation of the One Tournament Per Week and No Play After Withdrawal rules and will be withdrawn from all tournaments that week.

Case: A player moves from the Alternate list into a Challenger Singles Main Draw at the 10 AM deadline on Friday before the event and later appears in the draw. Not knowing that he is in the main draw of a tournament already, the player requests and receives a

VII. THE COMPETITION

Main Draw wild card at another Challenger tournament the same week and appears in the draw. Is the player allowed to withdraw from one of the events and compete at the other one?

Decision: No. The player is in violation of the One Tournament Per Week and No Play After Withdrawal rules and will be withdrawn from both tournaments that week.

E. Withdrawals from the qualifying competition at ATP Tour/Challenger Tour tournaments will be without penalty if one of the following occurs:

- 1) Player is accepted into the main draw of ATP Tour Masters 1000, ATP Tour 500 or ATP Tour 250 tournament, or in the case of an ATP Challenger Tour qualifying withdrawal, the main draw of another ATP Challenger Tour singles event.
- 2) Player is still competing in an ATP Tour, ATP Challenger Tour, or ITF Men's WTT tournament at any time on the day prior to the commencement of qualifying.
- 3) The first two (2) withdrawals are excused, thereafter, each withdrawal is subject to a fine in accordance with article 8.03 B., Fines.

7.06 One Tournament Per Week and Exception

A. Regulation:

A player may only enter and compete in one Grand Slam, ATP Tour, ATP Challenger Tour or special event during that tournament week. Once a player enters and is accepted into the main draw of singles, doubles, or the qualifying competition, he is committed to that tournament for the week, unless released by the Senior Vice President - Rules & Competition or Supervisor. A player who loses in the singles qualifying competition may enter the doubles event of any tournament.

Case: May a team who enters and loses doubles qualifying at an ATP 500 event on Saturday enter doubles in a Challenger for the same week.

Decision: No. This would violate the provisions of the One Tournament Per Week rule.

B. Exception:

A player who has lost in a tournament may enter the qualifying for a tournament scheduled for the next week*. The Supervisor may authorize a player who is still competing in the main draw of a tournament in singles and/or doubles to enter the qualifying for the next week's ATP Tour and ATP Challenger Tour tournaments provided that no special scheduling by either tournament shall be required. In the event of a conflict, he shall be withdrawn from such qualifying so as to compete in the singles and/or doubles of the main draw tournament in which he is competing. In addition, if the player does not appear for play as scheduled, there shall be an automatic fine.

*This does not apply to events in the same week as a Grand Slam qualifying event. Players accepted into the qualifying of a Grand Slam event will not be allowed to compete in any ATP Tour or ATP Challenger event (qualifying or main draw) held in the same week.

VII. THE COMPETITION

7.07 Play-Up Regulation (ATP Challenger Tour Tournaments)

A. Restrictions - Challengers 75-125

- 1) Players positioned 1-10 in the Pepperstone ATP Rankings twenty-one (21) days prior to the first Monday of the ATP Challenger Tour tournament are prohibited from entering, accepting a wild card and/or competing in an ATP Challenger Tour tournament. Players who would have been, had they and all other players entered, a direct acceptance on the original acceptance list for a Grand Slam are prohibited from entering, accepting a wild card and/or competing in an ATP Challenger Tour tournament in the first week of the Grand Slam tournament.
- 2) Players positioned 11-50 (excluding Entry Protection ranking) in the Pepperstone ATP Rankings twenty-one (21) days prior to the first Monday of the ATP Challenger Tour tournament are prohibited from entering (with the exception of Challenger 175 category) but may receive an ATP-approved wild card in order to compete in the Challenger tournament. The Challenger Supervisor will make wild card determinations consistent with the limitations outlined below. Players positioned 11-50 are also prohibited from entering, accepting a wild card or competing in a Challenger 75 tournament.
- 3) ATP Challenger Tour tournaments scheduled the same week as an ATP Tour tournament may offer wild cards to players positioned 11-50 in the Pepperstone ATP Rankings who have received approval from the ATP on-site Supervisor according to the following breakdown:

ATP Challenger 125	up to (2) two wild cards
ATP Challenger 100	up to (1) one wild card
ATP Challenger 75	no wild card

- 4) ATP Challenger Tour tournaments not scheduled in the same week as ATP Tour tournaments, or scheduled during the 2nd week of a Grand Slam, ATP Tour Masters 1000 96-draw tournaments may offer wild cards to players positioned 11-50 in the Pepperstone ATP Rankings who have received approval from the ATP on-site Supervisor according to the following breakdown:

ATP Challenger 125	up to (3) three wild cards
ATP Challenger 100	up to (3) three wild cards
ATP Challenger 75	no wild card

NOTE: These restrictions apply only to singles draws.

B. Restrictions - Challenger 50

Players positioned 1-150 in the Pepperstone ATP Rankings twenty-one (21) days prior to the first Monday of the ATP Challenger Tour tournament are prohibited from entering Challenger 50 events. ATP Challenger 50 tournaments may offer an ATP-approved wild card to players ranked 51-150 in the Pepperstone ATP Rankings at the entry deadline who have received approval from the ATP on-site Supervisor according to the following breakdown:

51-100	1 wild card limited to a player of the same nationality as the event
101-150	1 wild card - no nationality restriction

VII. THE COMPETITION

Case: A player ranked between 11-50 asks for a wild card into an ATP Challenger 75 and is denied by the tournament. The player then signs in for the qualifying. Is he allowed to play qualifying?

Decision: He is allowed to play only if the tournament grants him a wild card into the qualifying. The WC, however, will not count against the maximum allowed number of 11-50 players for the tournament.

Case: A player ranked 11-50 at the time of the entry deadline asks for a wild card into an ATP Challenger 75 and is denied by the tournament. The players ranking then drops below 50 and he signs in for the qualifying. Is he allowed to play qualifying?

Decision: Yes. Since his ranking dropped below 50, he is allowed to sign in and play qualifying and does not need a wild card.

Case: May a player who was ranked in the 11-50 range at the time of the entry deadline into an ATP Challenger 75 event, but whose ranking falls below this at the time of the qualifying sign-in, be accepted into the event as a main draw or qualifying wild card or sign-in for the qualifying event?

Decision: No. The rule under 7.07 A 2) states that these players are prohibited from entering, accepting a wild card or competing in an ATP Challenger 75 tournament.

7.08 The Draw

A. Minimum Draw Size

- 1) The singles draw size for ATP Tour Masters 1000 tournaments shall be:

ATP Tour Masters 1000	96 Draw
ATP Tour Masters 1000 / Outdoors	56 Draw
ATP Tour Masters 1000 / Indoors	48 Draw
- 2) With the exception of the Nitto ATP Finals, the minimum singles draw size for all other ATP Tour tournaments is as follows:

ATP Tour 500 / Outdoors	32 Draw
ATP Tour 500 / Indoors	32 Draw
ATP Tour 250 / Indoors & Outdoors	28 Draw*
- * ATP Tour tournaments may petition ATP for an increased size of the main draw. The deadline for submitting the petition is six (6) months prior to Monday of the tournament week.
- 3) Doubles draw sizes may be found under "Composition of Draws".

VII. THE COMPETITION

B. Composition of Draws - ATP Tournaments

- 1) **Main Draw Singles:** The singles main draw shall be composed as follows:

a) ATP Tour Masters 1000 Tournaments:

Total <u>Accepted</u>	Direct <u>Acceptances</u>	<u>Qualifiers</u>	Wild <u>Cards</u>	Special <u>Exempts</u>
48	38-39	6	3	0-1
56	44-45	7	4	0-1
96	78-79	12	5	0-1

b) ATP Tour 500 Tournaments:

Total <u>Accepted</u>	Direct <u>Acceptances</u>	<u>Qualifiers</u>	Wild <u>Cards</u>	Special <u>Exempts</u>
32	23-25	4	3-4*	0-1
48	36-38	6	4-5*	0-1
56	42-44	7	5-6*	0-1

*Applies only for an A+ player from the region

c) ATP Tour 250 Tournaments:

Total <u>Accepted</u>	Direct <u>Acceptances</u>	<u>Qualifiers</u>	Wild <u>Cards</u>	Special <u>Exempts</u>
28	19-21	4	3	0-2
32	23-25	4	3	0-2
48	38-40	4	4	0-2
56	45-47	4	5	0-2

NOTE: All ATP Tour 250 tournaments shall have a 16 draw qualifying regardless of the size of the main draw.

C. Composition of Draws - Challenger Tour Tournaments (unless otherwise approved by ATP)

1) Main Draw 32 Players

- a) 21/19 Direct Acceptances based on Pepperstone ATP Ranking
- b) 3 Wild Cards
- c) 6 Qualifying Positions
- d) 0-2 Special Exempts
- e) 0-2 JAS

2) Qualifying is a 24-player event for 6 positions in the main draw

- a) 18 Direct Acceptances based on most recent Pepperstone ATP Ranking.
- b) 4 Wild Cards
- c) 0-2 JAS

3) All Challenger events are 8-day events

- a) Play is Sunday through Sunday with the exception that Challengers scheduled in the week prior to a Grand Slam (same region) are approved for a Saturday final. All requests from Challengers not scheduled in the week prior

VII. THE COMPETITION

to a Grand Slam (same region) shall be considered on a case by case basis.

- b) The deadline for applying for a Saturday final is four (4) months prior to the first Monday of the event or prior to the tournament being added to the calendar, whichever is first.

4) Vacancies

- a) Any main draw vacancies occurring after the withdrawal deadline and prior to the start of Qualifying will be filled in ranking order from the original main draw acceptance list by players who have preserved their position on the list. Players from the main draw alternate list who are directly accepted into qualifying are considered to have preserved their eligibility. A player can only preserve his eligibility on one list. If there are no alternates from the original main draw acceptance list who have preserved eligibility, the vacancy will be filled by the highest ranked player from the qualifying or alternate list using the Pepperstone ATP Rankings, and then Pepperstone ATP Doubles Rankings, used for seeding.

After the start of the qualifying, any vacancy will come from the Lucky Loser/Alternate list. The Alternates will be placed below the players who lost in qualifying and shall be ordered based upon their position in the Pepperstone ATP Rankings, and then the Pepperstone ATP Doubles Rankings, used for seeding.

NOTE: In order to preserve his eligibility on the Acceptance List, the player must email the ATP Supervisor directly prior to 6 PM local time on the day before qualifying starts (email listed on detail sheet) and personally inform the Supervisor that he wishes to preserve his position on the Acceptance List and the player must leave a contact number. The player should ask for confirmation that the Supervisor has received the email in a timely manner. A player can only preserve his eligibility on one list.

D. Composition of Draws - Doubles: The doubles main draw shall be composed as follows:

1) ATP Tour 250/500 Tournaments: Direct Acceptances

<u>Singles</u>	<u>Doubles</u>	<u>Direct Acceptances</u>	<u>Wild</u>
<u>Draw Size</u>	<u>Draw Size</u>	<u>Advance Entry</u>	<u>Cards</u>
28/32	16	14*	2
48	16	14*	2
56	24	22*	2

*For ATP 500 - 1 from Qualifying

2) ATP Masters 1000 Tournaments: Direct Acceptances

<u>Singles</u>	<u>Doubles</u>	<u>Direct Acceptances</u>	<u>Wild</u>
<u>Draw Size</u>	<u>Draw Size</u>	<u>Advance Entry</u>	<u>Cards</u>
96	32	29	3
56*	28	25	3
48*	24	22	2

*Optional Draw Size for ATP Masters 1000 56 & 48 Draw Singles

VII. THE COMPETITION

<u>Singles</u>	<u>Doubles</u>	<u>Direct Acceptances</u>	<u>Wild</u>
<u>Draw Size</u>	<u>Draw Size</u>	<u>Advance Entry</u>	<u>Cards</u>
56	32	29	3
48	28	25	3

3) ATP Challenger Tour Tournaments

<u>Total</u>	<u>Direct Acceptances</u>		<u>Wild</u>
<u>Accepted</u>	<u>Advance Entry</u>	<u>On-Site</u>	<u>Cards</u>
16	10	4	2

E. Qualifying

ATP Tour: The Alternate Sign In for ATP Tour singles qualifying shall begin no later than 4 p.m. and close at 6 p.m. local time on the night prior to the start of the qualifying competition (Friday night when qualifying commences on Saturday). There shall also be an Alternate sign-in on the day of first round qualifying play, this deadline is one-half hour prior to the first scheduled qualifying match. This is a new sign-in and any player who is on-site and with a Pepperstone ATP Ranking (singles or doubles) is eligible to sign-in. Once the qualifying competition has begun, only those players who ultimately qualify and lucky losers may be accepted into the main draw. The qualifying competition commences when the first ball of the first qualifying match is struck.

ATP Challenger Tour. The on-site alternate sign-in shall begin no later than 4 p.m. and close at 6 p.m. local time on the night prior to the start of the qualifying competition. There shall also be an Alternate sign-in on the day of first round qualifying play, this deadline is one-half hour prior to the first scheduled qualifying match. This is a new sign-in and any player who is on-site and with a Pepperstone ATP Ranking (singles or doubles) is eligible to sign-in.-Qualifying vacancies occurring after the withdrawal deadline - 10 AM, Eastern Time, USA on Friday shall be filled from the on-site alternate sign-in using the most recent Pepperstone ATP Rankings.

Any main draw vacancies occurring after the withdrawal deadline and prior to the start of Qualifying will be filled in ranking order from the original main draw acceptance list by players who have preserved their position on the list. Players from the main draw alternate list who are directly accepted into qualifying are considered to have preserved their eligibility. A player can only preserve his eligibility on one list. If there are no alternates from the original main draw acceptance list who have preserved their eligibility, the vacancy will be filled by the highest ranked player from the qualifying or alternate list using the Pepperstone ATP Rankings, and then the Pepperstone ATP Doubles Rankings, used for seeding.

Once the qualifying competition has begun, only those players who ultimately qualify, lucky losers and eligible alternates may be accepted into the main draw. The qualifying competition commences when the first ball of the first qualifying match is struck. The Alternates will be placed below the players who lost in qual-

VII. THE COMPETITION

ifying and shall be ordered based upon their position in the Pepperstone ATP Rankings, and then the Pepperstone ATP Doubles Rankings, used for seeding.

NOTE: For ATP Challenger Tour qualifying tournaments, withdrawals occurring after 10 AM Eastern Time USA and prior to the draw* will be filled from that night's alternate sign-in. Vacancies occurring after the release of the qualifying draw, will be filled from the next day's on-site alternate list. Players must personally sign-in to be eligible as an on-site alternate.

* For events in a time zone where the qualifying draw is made prior to 10 AM Friday, Eastern Time USA, vacancies occurring after the Qualifying Alternate sign-in deadline but prior to the qualifying draw shall be filled from that night's alternate sign-in.

- 1) **Singles.** ATP Tour Masters 1000 and ATP Tour 500 qualifying draw size will be one-half (1/2) the size of the main draw. The qualifying size for all ATP Tour 250 tournaments shall be 16 with 4 qualifiers. The singles qualifying shall be composed as follows:

- a) ATP Tour Tournaments - Qualifying:

<u>Total Accepted</u>	<u>Direct Acceptances</u>	<u>Wild Cards</u>
16	13	3
16*	14	2
24	20	4
28	24	4
48	43	5

* Denotes ATP Tour 250 Qualifying

- b) ATP Challenger Tour Tournaments - Qualifying:

<u>Total Accepted</u>	<u>Direct Acceptances</u>	<u>Wild Cards</u>
24	20	4

- 2) **Doubles Competition.** The doubles qualifying shall be composed as follows:

ATP Tour 500 Tournaments Qualifying:

<u>Total Accepted</u>	<u>Direct Acceptances</u>	<u>Wild Cards</u>
4	3	1

7.09 Size and Method of Draw

A. Main Draw

1) Singles

- a) **28 Competitors.** A draw sheet with 32 places shall be used. After the seeds and byes are placed, the remaining players, including the qualifiers, shall be drawn and placed in the vacant spaces in the draw, beginning at the top of the draw.
- b) **32 or 64 Competitors.** A draw sheet of 32 or 64 places shall be used. After the seeds are placed, the remaining players, including the qualifiers, shall be drawn and placed in the vacant spaces in the draw, beginning at the top of the draw.
- c) **48 or 56 Competitors.** A draw sheet with 64 places shall be used. After the seeds and byes are placed, the remaining players, including the qualifiers,

VII. THE COMPETITION

shall be drawn and placed in the vacant spaces in the draw, beginning at the top of the draw.

- d) **96 Competitors.** A draw sheet with 128 places shall be used. After the seeds and byes are placed, the remaining players, including the qualifiers, shall be drawn and placed in the vacant spaces in the draw, beginning at the top of the draw.

2) Doubles

- a) The draw shall be for 16, 24 or 32 teams.
- b) Placing of seeds and byes and the drawing of the remaining teams, including qualifiers, shall be in accordance with the same principles used in the singles main draw.

B. Qualifying Draw

The qualifying draw shall be made in sections, and the winner of each section shall be given a place in the main draw, as determined by lot.

1) Singles

- a) If four (4) qualifiers are required, there shall be four (4) sections; six (6) qualifiers, six (6) sections; and so on. The draw shall be seeded and the selection of seeds shall be based on the most recent available and complete Pepperstone ATP Rankings list.
- b) There shall be no pre-qualifying event; however, a tournament may conduct a separate or local event to determine wild cards in the qualifying competition or main draw, and unsuccessful participants in this event are eligible to be considered for entry into the qualifying competition.

2) Doubles - ATP Tour 500

There shall be a four-draw event with one team qualifying.

Correct When Left Out of Draw

Case: After the qualifying draw has been made, it is discovered that player A, who was properly entered, has been left out of the draw. What is the procedure to correct this mistake?

Decision:

- If player A is unseeded, replace the last direct acceptance in the qualifying draw with player A in the draw. Follow this procedure if play has begun unless the last direct acceptance has begun his first match. If the last direct acceptance has started his first match then no correction is to be made and player A is left out of the draw.
- If player A is seeded, then if he is one of the top four (4) seeds he replaces seed four (4) and then seed four (4) replaces seed eight (8). Seed eight (8) then replaces the last direct acceptance. If player A is to be seeded 5-8, then he shall replace seed eight (8) and then seed eight (8) replaces the last direct acceptance. The same principle is followed for larger qualifying draws where you have a greater number of seeds. If play has begun, then the Supervisor shall evaluate the impact upon the draw and correct when possible. If the last direct acceptance has begun play, then no corrections are possible.

VII. THE COMPETITION

Correcting an Error in Seeding

Case: After the event has begun, it is discovered that a tie between 2 seeded players or teams was not broken correctly. What action may be taken?

Decision: If the players or teams involved in the error have not played their first match, then the error in seeding may be corrected by switching the positions of the affected players or teams.

Don't Have Eight Seeds

Case: In a qualifying draw, there are only seven (7) players listed in the Pepperstone ATP Rankings or the Pepperstone ATP Doubles Rankings. Since there will not be an eighth seed, how are seeds 5-7 placed in the Draw?

Decision: Draw seeds 5, 6 and 7 for placement in sections 2,3 and 4.

Main Draw Seed for a Qualifier

Case: May a player who gains a place in the main draw by qualifying be seeded in the main draw?

Decision: Yes. However, if the main draw is made prior to the completion of the qualifying, then the original seedings are final.

Who to Seed in singles Qualifying

Case: Seven (7) players listed in the Pepperstone ATP Rankings sign in for the singles qualifying. Two (2) other players listed in the Pepperstone ATP Doubles Rankings sign-in along with fifteen (15) other players. How many and which players will be seeded?

Decision: Eight (8) players. The seven (7) singles players and the highest-positioned doubles player.

Player Pulled from ATP Tour 250 and 500 Qualifying

Case: An ATP Tour 500 and an ATP Tour 250 or a different ATP Tour 250 or 500 event are being held the same week. Can a player inside the original cut of the ATP Tour 250 or 500 qualifying list be withdrawn in order to be moved into the main draw of the ATP Tour 250 or 500 or a different ATP Tour 500 or 250 event or accept a wild card?

Decision: Yes.

7.10 Special Exempts (SE)

A. Eligibility

Players may receive a special exempt into the main draw of the following week's tournament if they meet the criteria and apply for it in a timely manner.

- 1) A player is eligible to receive a special exempt into the singles main draw of the following week's tournament, subject to the provisions of this section, if he is unable to compete in that qualifying competition because he is still competing on the date the qualifying competition begins in another qualified event, and his current ranking as of the date of the entry deadline would not have otherwise qualified him as a direct acceptance on the original acceptance list if he had entered. In addition, a player who is still playing a match at 9 p.m. local time at the qualifying site, is eligible to receive a special exempt only if he wins that match.

VII. THE COMPETITION

- a) A Qualified event for special exempt to an ATP Tour Masters 1000 tournament is the singles event of another ATP Tour Masters 1000, ATP Tour 500 or Grand Slam tournament.
- b) A Qualified event for special exempt to an ATP Tour 500 tournament is the singles event of another ATP Tour 500, ATP Tour Masters 1000, ATP Tour 250* or Grand Slam tournament.
*The 250 event must be located in the same region as the 500 event, as determined by ATP and specified in "Exhibit M".
- c) A Qualified event for special exempt to an ATP Tour 250 tournament is the singles event of any ATP Tour 250, ATP Tour 500, ATP Tour Masters 1000 or Grand Slam tournament.
- d) A Qualified event for special exempt to an ATP Challenger Tour tournament is the singles event of an ATP Tour or ATP Challenger Tour tournament within the same geographic region, unless there are no Challengers in the same region the following week. If there are no Challengers in the same region the following week, then a qualified event would include all ATP Challenger Tour events scheduled in the following week, regardless of region. (Definition of Regions can be found in "Exhibit M").
EXCEPTION 1: A player who has entered and been accepted into the qualifying draw of an ATP Tour tournament and has been withdrawn because he is still competing in a Challenger or Tour event in the same region, will be added to the last position on the special exempt list of an ATP Challenger Tour tournament scheduled for the next week, even though he would have been a direct acceptance, had he entered the Challenger.
Note: EXCEPTION does not apply if player was Top 50 twenty one (21) days prior to the first Monday of the Challenger.
EXCEPTION 2: A player who has entered and been accepted into the qualifying draw of an ATP Tour 500 tournament and has been withdrawn because he is still competing in an ATP Tour event, will be added to the last position on the special exempt list of an ATP Tour 250 tournament located in the same region (as determined by ATP) if specific conditions are met. These conditions are:
 - i) He is qualified for a Special Exempt spot in the ATP Tour 500 event.
 - ii) Due to other qualified player(s) for the Special Exempt into the ATP Tour 500 event there is no Special Exempt available.
 - iii) The player's ranking would have qualified him for the main draw of the 250 event, had he entered there instead of the 500 qualifying.

B. Number of Special Exempts

ATP Tour Masters 1000 and ATP Tour 500 tournaments shall have one (1) special exempt. ATP Tour 250 and ATP Challenger Tour tournaments shall have two (2).

C. Selection of Special Exempt

- 1) If there are not sufficient special exempt places in the draw for applicants, the players shall be selected according to their position on the most recent Pepperstone ATP Rankings list issued prior to the tournament or by their protected ranking, except:
 - a) If he is a direct acceptance using his protected ranking, then he is not eligible for a special exempt place, or
 - b) If he would have been a direct acceptance had he entered using his protected ranking, then the protected ranking cannot be used to determine his position on the special exempt list.

VII. THE COMPETITION

- 2) **ATP Tour.** If the special exempt places are not needed before the beginning of the qualifying competition, the special exempt places shall be filled by additional direct acceptances selected from the original acceptance list. Thus a player may be pulled out of the qualifying before the first ball is hit and replaced by an alternate list player.
- 3) **ATP Challenger Tour.** If the special exempt place is not needed prior to the 10 AM withdrawal deadline, the special exempt place shall be filled by an additional direct acceptance selected from the original acceptance list. If the special exempt place has not been determined at the deadline, and then following the 10 AM-withdrawal deadline it is determined that the Special Exempt is not needed, the additional direct acceptance shall be filled from the next player who has properly preserved his eligibility on the original acceptance list for that event.

D. Special Exempt Process

- 1) A list of possible eligible players is compiled by the player relations department by Wednesday/Thursday of the current week for the next week's tournaments.
- 2) The list of eligible players is supplied to the supervisors where the players are competing. The supervisors need to contact each player to inquire if the player is interested in the special exempt position and then contact player relations immediately following the player's decision to remove himself from consideration for any tournament for which he is eligible.
- 3) If the player is interested in an event, player relations coordinates with the supervisors at both events until the SE positions are filled.
- 4) If the main draw is to be made before a potential special exempt player plays on Friday, then such place(s) shall be drawn in the same manner as qualifier, i.e., four qualifiers ("Q") and one or two "SE" depending on whether there are one or two possibilities. Each of the five or six slots are marked "Q/SE." As soon as the "SE" match results are known, either the "SE" or the next direct acceptance (if the SE lost) is randomly drawn and inserted into the draw.

NOTE: The deadline for a player to declare his intent to accept a Special Exempt, if eligible, is no later than one hour following the completion of the match that qualified him for a Special Exempt. Once he has declared his intent to the Supervisor or Player Relations staff, he must accept the Special exempt, if eligible, or be subject to the applicable withdrawal/late withdrawal penalties.

- 5) If, on the day prior to the start of qualifying, a player does not finish his match by nine (9) p.m. local time at the qualifying site and subsequently loses his match, then he is not eligible to be signed in for qualifying or for a special exempt; however, he may receive a wild card from the tournament if it is known before the qualifying draw that he has lost and that no special scheduling shall be required.
- 6) A player who does not appear after accepting a special exempt shall be treated as an entered player and shall receive appropriate penalties.

Potential Special Exempt Playing at 9 p.m. Friday

Case: A player is competing in the singles event of a "qualified event" on the night before the next week's qualifying. If the player wins, he will be eligible for a special exempt. His singles match, however, will not be completed by 9 p.m. local time at the qualifying site for the next week's tournament. How does this affect the "composition of draws" at the next week's tournament?

VII. THE COMPETITION

Decision: The special exempt slot in the main draw shall be left available pending the result of the player's match. The qualifying draw should be made as required at 9 p.m. unless it is prudent to wait up to an hour for the match result. If the player vying for the special exempt loses, then the unused special exempt place shall be filled by the next player on the original acceptance list*. If the next player on the original acceptance list is in the qualifying draw, then he shall be withdrawn and moves into the main draw. The vacancy created in the qualifying draw shall be filled from the qualifying alternate list.

*For ATP Challenger Tour events, the vacancy is filled from the next player on the Acceptance List who properly preserved his eligibility at that event.

Potential Special Exempt Loses: After 9 p.m.

Case: A potential special exempt player loses his match at 9:15 p.m. on Friday night and he calls the qualifying sign-in site requesting that he be given a wild card into the singles qualifying competition. May a wild card be given to him for the next week's tournament if the qualifying draw has not been made?

Decision: Yes. The wild card belongs to the tournament, which may give it to this player as long as the draw has not been made and no special scheduling is required because of the travel plans of the player.

Potential Special Exempt Playing at Midnight Friday

Case: Same situation as above, except that the player's match is still in progress after midnight. Does this make the player eligible for a special exempt based on the fact that he was still competing on the date the qualifying competition begins in another qualified event?

Decision: No. For the purpose of the rule, competing on the date the qualifying competition begins shall be defined as: "Starting or resuming a match as part of that day's (normally Saturday) scheduled program". If the player wins the match, he is eligible to be considered for a special exempt position.

Special Exempt Awarded if Player Is in Semis?

Case: A tournament has a Saturday final and a player asks for a special exempt after he wins his quarterfinal match on Thursday. Is he eligible?

Decision: No. The player must be scheduled to play on Saturday when the "qualifying begins".

Case: A player is a potential special exempt for one or more Challenger tournaments. Can he also preserve his eligibility on an original acceptance list?

Decision: Yes. A player who is a possible special exempt may also preserve his eligibility on an original acceptance list, however the player may only preserve his eligibility on one list.

NOTE: If he preserves his eligibility on an original acceptance list and gets in that main draw before he has completed his match for the special exempt spot, he would be removed as a possible special

VII. THE COMPETITION

exempt. Conversely, if he wins his match and thus becomes the special exempt before he is accepted in the main draw from the original acceptance list, his name would be removed from eligibility on the original acceptance list. He is obligated to compete at whichever tournament he gets in the main draw first. Before he is accepted in the main draw from the original acceptance list, his name would be removed from eligibility on the original acceptance list. He is obligated to compete at whichever tournament he gets in the main draw first.

Case: *A player has won a position as a Special Exempt but he is also next on the Acceptance List. After the draw is made, but prior to the start of the qualifying competition, there is a late withdrawal and the player gets in due to the withdrawal. Does his status change from SE to Direct Acceptance, thus allowing the Special Exempt to go to the next player who earned the Special Exempt spot?*

Decision: *Yes, since the player ultimately got in because he was next on the list, this frees up the Special Exempt for the next player who earned it. If there are no Special Exempts, the list drops by the applicable number of spots.*

Am I kept on the Special Exempt List?

Case: *A player expresses an interest in a Special Exempt spot prior to the match that will qualify him for the position and becomes a possible Special Exempt. He does not contact the Supervisor or Player Relations staff member to accept the Special Exempt within one hour after the completion of the match that qualifies him. Is he kept on the list of possible Special Exempts?*

Decision: *No. If the player does not contact the Supervisor or Player Relations staff member no later than one hour following the completion of the match that qualified him, to accept the Special Exempt spot, he will be taken off the list of possible Special Exempts.*

Must I Appear for Play After Accepting a Special Exempt?

Case: *A player is listed as a possible Special Exempt and the Supervisor confirms with him that he is interested in the spot. There are other Special Exempt players ahead of him on the list of possible Special Exempts whose matches are scheduled after his. No later than one hour after the match that qualifies him as a Special Exempt, he informs the Supervisor or Player Relations staff member that he accepts the Special Exempt spot. If the remaining possible Special Exempt players ahead of him on the list lose their matches, thus earning him the Special Exempt spot, must he accept the Special Exempt?*

Decision: *Yes. Because he had accepted the Special Exempt spot within one hour after the match that qualified him, he is obligated to accept the position and shall be treated as an entered player and be subject to the appropriate penalties if he does not appear for play.*

Case: *Can a player with no ranking receive a Special Exempt if otherwise eligible?*

Decision: *No. A player must have a singles ranking or a singles protected ranking in order to be considered for a Special Exempt.*

Case: *May a player who has entered and been accepted into an*

VII. THE COMPETITION

ATP Tour Qualifying draw starting on Sunday be considered for a possible Challenger Special Exempt position for the following week?

Decision: *Yes, however the player must decide on Friday within an hour after winning his match whether he will accept the Challenger SE or stay on the ATP Qualifying list. Should the player decide to accept an available Challenger SE position, he will be withdrawn from the ATP Qualifying with "still competing".*

7.11 Time of Draw

A. Main Draw

- 1) **Singles.** The tournament shall publicly make the singles draw no earlier than 10 AM Eastern Time, USA, on Friday prior to the Monday of the tournament week and no later than 10 p.m. local time two (2) days before the first day's play, unless the tournament receives prior written permission from ATP. The time and place of the draw shall be determined by the tournament. For events approved for a Sunday start, the draw shall be made no earlier than 10 AM Friday, Eastern time USA and no later than 12 noon local time the day prior to the start of the event.
- 2) **Doubles.** The draw for doubles is to be made as soon as possible after the on-site entry deadline unless otherwise approved by the Supervisor. If the draw for a tournament is played over eight (8) or more days, then the draw is to be made by midnight of the second day. Once the draw is finalized there can be no change except for substitution. Doubles main draw matches shall not begin until all doubles qualifying matches are completed unless approved by the Supervisor.

B. Qualifying

- 1) **Singles – ATP Tour.** The qualifying competition draw shall be made and the order of play announced as soon as possible but no earlier than 6:00 pm local time on the day prior to the start of the qualifying.
- 2) **Singles – ATP Challenger Tour.** The qualifying competition draw shall be made and the order of play announced as soon as possible but no earlier than 3:00 pm local time on the day prior to the start of the main draw.
- 3) **Doubles - ATP Tour 500.** The qualifying competition draw shall be made and the order of play announced as soon as possible following the sign-in deadline unless otherwise determined by ATP.

7.12 Wild Cards

A. Regulations

- 1) **Singles.**
 - a) Wild cards are players included in the main draw at the sole discretion of the tournament. Wild cards must be named at the time the draw is made. Wild cards may be seeded. Tournaments may not receive compensation and players may not offer compensation in exchange for the awarding of a wild card.
 - b) A wild card is no longer eligible as an alternate at that event.
 - i) A main draw wild card may not be re-classified as a direct acceptance, due to withdrawals, once the acceptance list is finalized (when the first chip of the main draw has been drawn).

VII. THE COMPETITION

- ii) A qualifying wild card is eligible to be moved into the main draw as a direct acceptance, due to withdrawals, up to the start of the qualifying event.
- c) Once a qualifying competition has commenced (first ball of the first qualifying match is struck), an entered player may not be offered nor the player accept a wild card into any tournament that week.
- d) A tournament may not offer a wild card or accept the entry from any player who has either accepted a wild card or been committed by an entry method to another tournament in the same week.

2) Singles – ATP Tour 500

An additional Wild Card is awarded to the tournament with the following restrictions.

- a) The Wild Card must be named no later than 10 AM, Eastern Time, USA on the Friday before the event week; and
- b) The player must be an A+ player as designated by that event's region.
- c) If the tournament does not use the additional Wild Card by the deadline then the position in the main draw goes to the next eligible player on the entry list.

3) Doubles.

A tournament may not enter players as a wild card team without the consent of both players. A wild card may be offered to any team that is not a direct acceptance on the original acceptance list after entries have closed. A wild card may be offered to one player on an entered team if it is conditioned on his playing with a specific player. Wild cards must be named at the time the draw is made. Wild cards may be seeded. Tournaments may not receive compensation and players may not offer compensation in exchange for the awarding of a wild card.

B. Limitation

- 1) **Singles.** Players may accept up to five (5) main draw singles wild cards into ATP Tour tournaments during any ATP Circuit Year. Wild cards shall only count toward the annual limit if the player would have been a direct acceptance on the original acceptance list. Additional exceptions are outlined below.
 - a) Players who cannot participate in ATP Tour tournaments and ATP Challenger Tour tournaments for six (6) months because of a physical injury may petition ATP for one additional wild card.
 - b) In the event that a player's position in the Pepperstone ATP Rankings is insufficient to make him a direct acceptance on the forty-two (42) day acceptance list, then he shall be released from his commitment to that tournament, unless offered a wild card to the contract tournament within twenty-four (24) hours of the entry deadline. Such wild card accepted by a player shall not count in the player's annual limitation of five (5) wild cards in singles.
 - c) Any player who becomes thirty-five (35) years of age by December 31 of an ATP circuit year shall be exempt from the wild card limitation if he is:
 - i) A former singles Champion of a Grand Slam; or
 - ii) A former singles Champion of the ATP World Championships, Tennis Masters Cup or Nitto ATP Finals; or
 - iii) A former No. 1 ranked player in the ATP Rankings prior to January 2000; or
 - iv) A former No. 1 player in the year-end ATP Rankings.
 - d) Players may petition ATP for exceptions to these limitations.
- 2) **Doubles.** There shall be no limitations of doubles wild cards for players.

VII. THE COMPETITION

Two Chances

Case: Can a player who loses in the qualifying receive a wild card into the main draw?

Decision: No.

Wild Card After ATP Tour Qualifying Withdrawal

Case: A player withdraws from the qualifying of an ATP Tour tournament on Friday at any time because he is still competing in an ATP Challenger Tour tournament. The player is offered a wild card in another ATP Challenger Tour event to be held the following week. May the player accept the wild card or do the provisions of "No Play After Late Withdrawal" apply?

Decision: The player is allowed to accept the wild card. Because the player was competing in a qualified event on the Friday, he is allowed to withdraw from the ATP Tour qualifying event without penalty and therefore it is not considered as a "Late Withdrawal".

Wild Card Pulled from Challenger Qualifying

Case: After a Challenger qualifying draw has been made but before that challenger qualifying competition has officially begun, may a player who is included in that qualifying draw be offered and accept a wild card into that or another tournament's main draw?

Decision: Yes. As long as the qualifying competition has not begun (first ball is struck), a player may accept a wild card into the main draw of any ATP Tour or ATP Challenger Tour tournament and be withdrawn from that qualifying event. The vacancy created in the qualifying shall be filled by an eligible alternate.

Unused Wild Cards

Case: A tournament elects not to use all of its main draw singles wild cards. How are these spots filled?

Decision: If the qualifying has not begun, the next player on the acceptance list is moved into the main draw. If qualifying has begun, a lucky loser is to be inserted into the main draw.

7.13 Selection of Entries

A. Singles Main Draw

- 1) **Direct Acceptances.** Direct acceptances are players accepted directly in the draw by virtue of their position in the Pepperstone ATP Rankings or by their protected ranking position (singles). The list to be used for ATP Tour tournaments shall be dated approximately forty-two (42) days prior to the Monday of the (first) tournament week and twenty-one (21) days prior to the Monday of the tournament week for ATP Challenger Tour tournaments.
- 2) **Qualifiers.** Qualifiers are players who are included in the main draw as a result of their success in a qualifying competition. If the main draw is made prior to the completion of a qualifying competition, it shall include as many qualifying places as there are sections in the qualifying draw. Each of these qualifying places shall be positioned in the main draw in accordance with standard drawing procedures. Determination as to which qualifier goes into which qualifying place shall be by drawing after the qualifying competition ends.

VII. THE COMPETITION

- 3) **Special Exempts (SE).** Players may receive a special exempt into the main draw of the following week's tournament if they meet the criteria and apply for it in a timely manner. If the main draw is to be made before a potential special exempt player plays on Friday, then such place(s) shall be drawn in the same manner as qualifier, i.e., four qualifiers ("Q") and one or two "SE" depending on whether there are one or two possibilities. Each of the five or six slots are marked "Q/SE." As soon as the "SE" match results are known, either the "SE" or the next direct acceptance (if the SE lost) is randomly drawn and inserted into the draw.

NOTE: Once a player has become eligible for Special Exempt consideration, he must confirm to the Supervisor or Player Relations staff no later than one (1) hour following the completion of the match that qualified him for a Special Exempt, that he is applying for the Special Exempt position.

- 4) **Wild Cards.** Wild cards are players included in the main draw at the sole discretion of the tournament.* Wild cards must be named at the time the draw is made. Wild cards may be seeded. Tournaments may not receive compensation and Players may not offer compensation in exchange for the awarding of a wild card.

* See 7.12 A. 2) for restrictions pertaining to ATP Tour 500 additional Wild Card.

May I Accept a Challenger Wild Card after Losing in an ATP Tour Qualifying?

Case: Can a Tournament Director at a Challenger, which is held in the same week as an ATP event, request permission to offer a main draw wild card to a player who has lost in the qualifying of the ATP Tour event?

Decision: No. A player may only compete in one tournament per week.

May I Play Grand Slam Qualifying After Losing in an ATP Tour tournament?

Case: Can a player lose in the main draw of an ATP event, which is held the week before a Grand Slam tournament, and be eligible to compete in the qualifying for the Grand Slam event that is held that same week?

Decision: Yes, as long as he meets the entry deadline set by the Grand Slam event. The player is not violating the one tournament per week rule because the main draws for the two events are in different weeks.

May I Accept a Wild Card after Withdrawing from an ATP Tour Qualifying?

Case: A player was still competing in a Challenger on the day before Qs started at an ATP Tour event. He wanted to withdraw from the Qs due to "still competing" and then take a wild card into a Challenger event. Is this allowed?

Decision: Yes. The rule states that he may withdraw without penalty from the qualifying if he is still competing on the day prior to the commencement of the qualifying. By withdrawing due to "still competing", he is allowed to accept a wild card.

May I Sign In for Doubles after Withdrawing from an ATP Tour Qualifying?

Case: A player was still competing on the day before Qs started at an ATP Tour event. He wanted to withdraw from the Qs due to "still

VII. THE COMPETITION

competing" and then sign in for doubles at the same or other event. Is this allowed?

Decision: Yes. The rule states that he may withdraw without penalty from the qualifying if he is still competing on the day prior to the commencement of the qualifying. The "without penalty" would relieve him from the "No Play After Withdrawal" provisions of the rules.

B. Singles Qualifying

- 1) **Direct acceptances – ATP Tour.** Direct acceptances are players accepted directly in the draw by virtue of their position in the Pepperstone ATP Rankings or by their protected ranking position (singles). The list to be used for ATP Tour tournaments shall be dated approximately twenty-one (21) days prior to the Monday of the tournament week.

- a) If there are still places available for direct acceptances in the qualifying draw, the next players selected shall be those with the highest position on the most recent Pepperstone ATP Doubles Rankings list.
- b) There shall be an alternate sign-in list comprised of players that sign in who are not selected as direct acceptances. In the event that direct acceptance players are not present for first-round qualifying matches or if players are moved into the main draw from the qualifying (before the first ball is hit), players shall be selected from the alternate sign-in list in the order described in sections 1), and 2) above. Alternate sign-in deadline is 6:00 pm local time the day before the start of the qualifying. Thereafter, the deadline is one half (1/2) hour before the first scheduled match each day an Alternate may be required.

2) Direct acceptances – ATP Challenger Tour (50-125).

- a) **Qualifying Sign-In.** Players who personally sign-in for the qualifying event shall be accepted based upon their position on the most recent Pepperstone ATP Ranking followed by the most recent Pepperstone ATP Doubles Ranking.

The sign-in shall also include those players coming from other events who are eligible to be signed-in by the ATP Supervisor or Tournament Referee.

Case: A player enters an event using his current ranking. After the deadline, he realizes he did not get in with his current ranking and informs the Supervisor that he wants to use his protected ranking. May he do this?

Decision: No, the intent to use a protected ranking must be declared at the time of entry and cannot be declared after the deadline for the event.

- b) **On-Site Alternate Sign-In.** There shall be an on-site alternate sign-in on the day of the start of qualifying. The sign-in deadline is one half (1/2) hour before the first scheduled qualifying match.

Priority for the on-site alternate sign-in is based upon the most recent Pepperstone ATP Ranking and then players using their most recent Pepperstone ATP Doubles Ranking.

- 3) Any vacancy created by the withdrawal of a seed (for any reason), after the qualifying draw has been made but prior to the release of the order of play for the first day of the qualifying event, shall be filled by the next highest positioned player or team in the qualifying draw eligible to be seeded. The position vacated by that

VII. THE COMPETITION

next highest positioned player or team shall then be filled by the next eligible player or team on the qualifying draw alternate list.

Can I Sign In

Case: An ATP Tour tournament with an advanced entry qualifying holds an Alternate Sign In on Friday night. If a player does not sign-in on Friday night, may he sign-in on the Saturday morning Alternate sign-in sheet?

Decision: Yes. Following the sign-in occurring prior to the qualifying draw being made, the Alternate sign-in on the day of first round play is a new list and any player who is on-site and with a Pepperstone ATP Ranking (singles or doubles) is eligible to sign-in.

Unranked Players as Alternates

Case: The tournament has used their wild card allocation. Are players without a ranking eligible to sign in as alternates?

Decision: No. Unranked players are only allowed into the draw as a wild card selection.

Fill by Random or Alternative Method

Case: After concluding the qualifying sign-in, there are not a sufficient number of players listed in the Pepperstone ATP Rankings (singles/doubles) to fill the draw. If there are still additional vacancies, may the Tournament Director fill the remaining spots with players according to the local system?

Decision: No. Unranked players are only allowed into the draw as a wild card selection.

Case: A player asks to be signed-in to the doubles qualifying which begins on Saturday. He is in another tournament and is playing the doubles final scheduled for Saturday. He asks that he be signed-in if he gets a bye for Saturday, as he would not be able to play the qualifying on Saturday.

Decision: The entry for doubles qualifying cannot be accepted. The player could sign-in for main draw doubles, but not for qualifying.

C. Doubles Main Draw - ATP Tour. Direct acceptances for ATP Tour events shall be in the following order:

- 1) Teams composed of players in either the Pepperstone ATP Rankings or the Pepperstone ATP Doubles Rankings. The combined positions of the two players using best Pepperstone ATP Rankings (singles or doubles) shall be added together and the total used to determine the direct acceptances. The most recent Pepperstone ATP Rankings and/or Pepperstone ATP Doubles Rankings list, including a protected ranking, shall be used.

Ties are broken as follows (including protected rankings):

- a) Team using two (2) doubles rankings.
- b) Team using one (1) doubles ranking.
- c) Team using two (2) singles rankings.

Note: For ties between teams with the same composition:

- i) For teams using two (2) Pepperstone ATP Doubles Rankings, the fewest number of doubles tournaments played and then the team with the highest number of points.

VII. THE COMPETITION

aa) If one (1) team is using a protected ranking, then they are placed below the team using two (2) actual rankings;

bb) If both teams have one (1) or two (2) members using a protected ranking, then the team with the strongest individual Pepperstone ATP Doubles Ranking, including protected ranking, will receive priority;

ii) For teams using one (1) singles & one (1) doubles - the team with the strongest individual Pepperstone ATP Doubles Ranking will receive priority;

iii) For teams using two (2) Pepperstone ATP Rankings, the team with the strongest individual Pepperstone ATP ranking.

iv) If none of the above break the tie, then the order shall be determined by a draw.

Case: A player enters an event using his current ranking. After the deadline, he realizes he did not get in with his current ranking and informs the Supervisor that he wants to use his protected ranking. May he do this?

Decision: No, the intent to use a protected ranking must be declared at the time of entry and cannot be declared after the deadline for the event.

- 2) If the doubles draw cannot be filled by teams where both members are listed in the Pepperstone ATP Rankings or Pepperstone ATP Doubles Rankings, the remaining places shall be filled with byes.

Only One Doubles Player Has Ranking

Case: A doubles team has one player who is listed in the Pepperstone ATP Rankings or Pepperstone ATP Doubles Ranking and one player who is not. Can the team be in the doubles draw?

Decision: Since one player does not have a ranking, the only way into the draw is via a wild card.

NOTE: The rationale for this is that all players, except Wild Cards, must be an ATP member or a registered player. Since one player of the team does not have a ranking, he is not eligible to register and therefore the only way into the draw is via Wild Card.

Use of Both Rankings

Case: A player has a protected singles ranking of 201, true singles ranking of 458, protected doubles ranking of 320 and true doubles ranking of 408. Can the player use his protected singles ranking to enter doubles when he has already used it to enter the singles of that tournament or does he have to use his 'true' singles ranking or his protected doubles ranking?

Decision: The protected singles ranking CAN be used for entry into the doubles. It would not count against his allowed total for singles events but would count against his doubles allotment.

D. Doubles Main Draw – ATP Challenger Tour

Challenger 50-125

Direct acceptances for ATP Challenger events shall be in the following order:

- 1) Teams composed of players in either the Pepperstone ATP Rankings or the Pepperstone ATP Doubles Rankings. The combined positions of the two players (using best Pepperstone ATP Rankings - singles or doubles) shall be added together

VII. THE COMPETITION

and the total used to determine the direct acceptances. The most recent Pepperstone ATP Rankings and/or Pepperstone ATP Doubles Rankings list, including a protected ranking, shall be used.

Ties are broken as follows (including protected rankings):

- a) Team using two (2) doubles rankings.
- b) Team using one (1) doubles ranking.
- c) Team using two (2) singles rankings.

Note: For ties between teams with the same composition:

- i) For teams using two (2) Pepperstone ATP Doubles Rankings, the fewest number of doubles tournaments played and then the team with the highest number of points.
- ii) If one (1) team is using a protected ranking, then they are placed below the team using two (2) actual rankings;
- iii) If both teams have one (1) or two (2) members using a protected, then the team with the strongest individual Pepperstone ATP Doubles Ranking, including protected ranking, will receive priority;
- iv) For teams using two (2) Pepperstone ATP Rankings, the team with the strongest individual Pepperstone ATP Doubles Ranking will receive priority.
- v) For teams using two (2) Pepperstone ATP Rankings, the team with the strongest individual Pepperstone ATP Ranking will receive priority.
- vi) If none of the above break the tie, then the order shall be determined by a draw.

E. Seeds - ATP Tour and ATP Challenger Tour

Seeded teams will be determined by using the combined Pepperstone ATP Doubles Rankings of the two players (protected ranking not included). Ties shall be broken as follows:

- 1) The team with the fewest events played is positioned higher.
- 2) The team with the highest number of points is positioned higher.
- 3) A coin flip or draw if a tie remains.

F. Qualifiers

Qualifiers are teams who are included in the main draw as a result of their success in a qualifying competition. If the main draw is made prior to the completion of a qualifying competition, it shall include as many qualifying places as there are sections in the qualifying draw. Each of these qualifying places shall be positioned in the main draw in accordance with standard drawing procedures. Determination as to which qualifier goes into which qualifying place shall be by drawing after the qualifying competition ends.

G. Wild Cards. Wild cards are players included in the main draw at the sole discretion of the tournament. Wild cards must be named at the time the draw is made. Wild cards may be seeded. Tournaments may not receive compensation and players may not offer compensation in exchange for the awarding of a wild card.

VII. THE COMPETITION

7.14 Seeds Definition

Seeds are players who are given preferential positions in the draw based on the Pepperstone ATP Rankings. The selection and arrangement of seeds shall be based upon the most recent Pepperstone ATP Rankings list (the protected ranking is not considered). Each tournament shall have a seeded draw and there shall be only one seeding list. Seeding shall not be official until the final draw is made. For doubles, seeded teams will be determined by using the combined Pepperstone ATP Doubles Rankings of the two players (entry protection not included).

Any vacancy created by the withdrawal of a seed, after the draw has been made but prior to the release of the order of play for the first day of main draw, shall be filled according to the procedures described under vacancies.

Protected Ranking is for Entry, Not Seeding

Case: May a player's protected ranking be used for seeding purposes?

Decision: No. The protected ranking position can be used for: 1) entry into the qualifying competition and main draw, or 2) special exempt position. It may not be used for: 1) seeding, or 2) lucky loser order.

7.15 Number of Seeds

The number of seeds shall be as follows:

<u>Singles</u>		<u>Doubles</u>
4 competitors -	2 seeds (singles Q)*	4 teams - 2 seeds (Qualifying)
16 competitors -	8 seeds (singles Q)	16 teams - 4 seeds
24 competitors -	12 seeds (singles Q)	24 teams - 8 seeds
28 competitors -	14 seeds (singles Q)	32 teams - 8 seeds
48 competitors -	24 seeds (singles Q)	
32 competitors -	8 Seeds	
28 competitors -	8 seeds	
48 competitors -	16 seeds	
56 competitors -	16 seeds	
96 competitors -	32 seeds	

*ATP Challenger Tour Qualifying only

VII. THE COMPETITION

7.16 Placement of Seeds - Main Draw

The procedures for placing seeds in the main draw are as follows:

- A.** Place seed 1 on line 1 and seed 2 on line 32 (32 draw), line 64 (64 draw) or line 128 (96 draw); and
- B.** To determine the location of the remaining seeds, draw in groups according to the following chart:

Seeds	16 Draw 4 Seeds	32 Draw 8 Seeds	64 Draw 16 Seeds	96 Draw 32 Seeds
<u>3-4</u>				
First Drawn	5	9	17	33
Second Drawn	12	24	48	96
<u>5 - 8</u>				
First Drawn		8	16	32
Second Drawn		16	32	64
Third Drawn		17	33	65
Fourth Drawn		25	49	97
<u>9-12</u>				
First Drawn			9	17
Second Drawn			25	49
Third Drawn			40	80
Fourth Drawn			56	112
<u>13 - 16</u>				
First Drawn			8	16
Second Drawn			24	48
Third Drawn			41	81
Fourth Drawn			57	113
<u>17 - 24</u>				
First Drawn				9
Second Drawn				24
Third Drawn				41
Fourth Drawn				56
Fifth Drawn				73
Sixth Drawn				88
Seventh Drawn				105
Eighth Drawn				120
<u>25 - 32</u>				
First Drawn				8
Second Drawn				25
Third Drawn				40
Fourth Drawn				57
Fifth Drawn				72
Sixth Drawn				89
Seventh Drawn				104
Eighth Drawn				121

VII. THE COMPETITION

7.17 Qualifying Placement

A. Singles

- 1) There will be one section, having two (2) seeds, for each qualifying position in the main draw. The first seed shall be placed at the top of the first section. The second seed shall be placed at the top of the second section and so on until all sections have one (1) seed on the top line of each section. The remaining seeds shall be placed together and drawn with the first drawn placed on the last line of the first section, second drawn placed on the last line of the second section and continued in this manner until each of the sections have two seeds.
- 2) The names of the remaining players shall be drawn and placed in the vacant spaces not occupied by the seeds or byes beginning at the top of the draw.

B. Doubles

Two teams shall be seeded in a four-draw event with the seeds being placed on lines 1 and 4.

7.18 Byes - Assignment and Placement

A. Singles Main Draw

- 1) If there is a 32 main draw, no byes shall be awarded unless there are an insufficient number of direct acceptances.
- 2) If there is a 28 main draw, the top four (4) seeds shall be awarded a bye.
- 3) If there is a 48 or 96 main draw, each seed shall be awarded a bye.
- 4) If there is a 56 main draw, the top eight (8) seeds shall be awarded a bye. Any player who received a "bye" and loses in the second round shall receive second round loser's prize money but only first round loser's points for the Pepperstone ATP Rankings, if applicable.

B. Doubles Main Draw

- 1) If there is a 16 or 32 main draw, no byes shall be awarded.
- 2) If there is a 24 main draw, each seeded team shall be awarded a bye.
- 3) Any team that received a "bye" and loses in the second round shall receive second round loser's prize money but only first round loser's points for the Pepperstone ATP Doubles Rankings, if applicable.

C. Qualifying Draw

If there are not enough competitors to fill the qualifying draw, then after the seeds are placed in the draw, the required number of byes shall be awarded as follows:

- 1) Priority shall be to the highest seeds.
- 2) Remaining byes shall be drawn by groups of two (2) going into one (1) section (e.g., if there are 10 byes, eight go to seeds and the remaining two are drawn into one section; if there are 11 byes, nine and 10 are drawn into one section and the 11th is randomly drawn into one of the other three (for a 32 draw qualifying competition) remaining qualifying sections).

VII. THE COMPETITION

7.19 Remake of Draw

A. Singles

If two (2) or more of the top eight (8) seeds withdraw more than twenty-four (24) hours before the start of the singles tournament, the tournament may choose either to remake the draw or let the draw stand. If a wild card withdraws after the original draw and the draw is to be remade, the vacancy created may be filled at the tournament's option by a substitute wild card. If the tournament elects not to use a substitute wild card, the vacancy shall be treated as any other vacancy.

B. Doubles

Prior to the draw being finalized (not sooner than when it is published but not later than when the first ball of the doubles tournament is struck as determined by the Supervisor), use the following procedure: If one-fourth or more of the seeded teams withdraw, or a minimum of two (2) seeded teams in a 16-team draw withdraw, the Tournament Director has the option to have the draw remade if approved by the Supervisor. If the draw is remade, the original pairings may not be changed except where vacancies occur.

Case: *A draw has to be remade. How is the remake of the draw done?*

Decision: *There are 2 methods for remaking a draw: (1) Retaining the original order of the chips drawn and (2) Starting from the beginning and redrawing the chips.*

Retaining the original order of the chips drawn is the preferred method and is used in all cases except when the cause of the remake had to do with an issue with the chips, such as a loss of a chip; a chip being accidentally thrown back into the bowl and drawn a second time, etc.

In the instance of remaking the draw retaining the original order of the chips, the following procedure is followed:

- 1) The Chip List (order of the names of players and/or teams) is regenerated
- 2) The draw is populated using the list of chips drawn in the original order
- 3) No other action is taken

In the instance when the draw is remade by starting from the beginning and redrawing the chips., the following procedure is followed:

- 1) The Chip List (order of the names of players and/or teams) is regenerated.
- 2) The Chips are redrawn according to the procedures outlined in the ATP Rulebook 7.09

Where does the "No Match" go?

Case: *At an ATP Tour Qualifying, the draw is made and the OP is published on Friday night. Overnight, 3 withdrawals occur. The next morning, only 2 players sign in for the on-site alternate list leaving a "No Match" spot for the draw. How is it determined on which line the "No Match" is placed?*

Decision: *By random draw.*

VII. THE COMPETITION

7.20 Lucky Losers, Substitutions and Vacancies

A. Lucky Loser Selection

32/16Q Draw events shall use the same protocol as specified for ATP Tour events in section 7.20 A. 1) below.

A player may be entered in the main draw of a tournament if he meets the criteria outlined for a lucky loser.

- 1) Lucky losers are players who have lost in the final round of the qualifying event or, if more lucky losers are required, those players who have lost in the previous qualifying round(s). Lucky Losers shall be selected based on the computer rankings as follows: If there are no vacancies when the qualifying event has been completed, then the order of the Lucky Loser list shall be selected on the basis of their position on the Pepperstone ATP Rankings (singles or doubles) list used for determination of qualifying seeding (protected ranking is not considered). If there is a vacancy in the main draw when qualifying is completed then the order of the two (2) highest ranked players shall be randomly drawn, thereafter the order shall follow the players' rankings, unless there are two (2) or more withdrawals at the time the Qualifying competition is finished in which case the size of the random draw will be the number of withdrawals plus one (1). In the case where players from the previous round are included in the draw they will be placed behind all players who have lost in the final round of qualifying. Only those accepted into the qualifying competition may sign in as lucky losers.
- 2) The lucky loser list shall be posted each day at least one (1) hour before the sign-in deadline, which shall be one-half (1/2) hour before the first scheduled match of the day. If rain or other disruptions occur, then the Supervisor can change the deadline as appropriate. Such list shall not be available for sign-in on the preceding day. All lucky loser sign-in deadlines must be placed on each day's schedule of play.
- 3) The sign-in for doubles lucky losers or alternates shall follow the same procedures as the sign-in for singles lucky losers or alternates. One member of a lucky loser team may sign in for the team. If there is no qualifying competition, substitutions shall come from the alternate list of teams not accepted directly into the main draw through the on-site sign-in procedure. In either case, only substitutions of the originally paired teams are permitted. If two (2) or more positions become available at the same time during the preceding period, the positions to be occupied shall be determined by drawing.
 - a) There shall be one Lucky Loser / alternate sign-in sheet that will have all eligible Lucky Loser / alternate* teams listed.
 - b) The system of merit for alternates is based on the same method as used in the system of merit for entry.
 - c) The system of merit for Lucky Losers is based on the same method as used to determine seeding.
- 4) Vacancies in ATP Tour 500 Doubles main draw will be filled by the following method:
 - a) Team losing in the final round of qualifying shall be the number 1 lucky loser; and

VII. THE COMPETITION

- b) The two teams losing in the first round of the doubles qualifying shall be numbers two (2) and three (3) based upon their ranking as used in the determination of seeds; and then
 - c) All teams who signed in for the on-site alternate entry list and were not accepted or could not participate in the qualifying and shall be ordered based upon their rank on the acceptance list.
 - d) Teams who did not enter through the online on-site alternate sign-in are eligible* to sign the daily alternate sign-in and are placed below those teams on the alternate list as defined in a), b) and c) above.
 - e) One player from each team must sign the daily lucky loser / alternate sign-in sheet to be eligible to fill a vacancy.
 - * To be eligible, alternate teams who did not enter through the online protocol must sign-in on the first day of the doubles competition.
- 5) Vacancies in ATP Masters 1000 and ATP Tour 250 Doubles main draws occurring after the withdrawal deadline but prior to the draw being made will be filled by the next team on the on-site alternate list.
- 6) Vacancies in ATP Masters 1000 and ATP Tour 250 Doubles main draws occurring after the draw has been made will be filled by the first of the following methods:
- a) Teams who were not accepted into the main draw through the on-site alternate sign-in list; then
 - b) Teams who did not enter through the online on-site alternate sign-in and teams where one member of the team is eligible to re-pair following the withdrawal of his partner are eligible* to sign the daily alternate sign-in and are placed below those teams on the alternate list who did enter through online on-site alternate sign-in method.
 - * To be eligible, alternate teams who did not enter through the online protocol must sign-in on the first day of the doubles competition.
- 7) Teams may remain on the alternate list for multiple events in the same week, however, they may only sign-in at one of those events on any given day.
- 8) Vacancies in Challenger Doubles main draw will be filled from the on-site alternate list using the same protocol as used for entries. Teams who did not enter through the on-site sign-in and teams where one member of the team is eligible to re-pair following the withdrawal of his partner are eligible* to sign the daily alternate sign-in and are placed below those teams on the alternate list who did enter through the on-site sign-in method.
 - * To be eligible, alternate teams who did not enter through the on-site protocol must sign-in on the first day of the doubles competition.

Case: A team submits an advance entry for a 250 tournament with one of the players using a protected ranking. They are among 6 teams not ranked high enough to be selected. The other 5 teams are using their best of rankings. Where is the team using the protected ranking placed on the alternate list if they are the next team in based on that ranking or the 4th highest team using their best of ranking?

Decision: The team using the protected ranking is placed at the top of the alternate list. Protected ranking is used for entry into a tournament either directly or as an alternate (either an advanced entry or as an on-site entry).

VII. THE COMPETITION

Who is inserted as the doubles alternate?

Case 1: After the sign-in deadline for doubles alternate has closed, there are 7 teams signed-in. At 16:55 a team scheduled to play at 17:00 withdraws due to injury of one of the players. The #1 team on the alternate list is inserted into the draw. The match is called at 17:00. It is discovered that the inserted team is at the hotel and at 17:15 the alternate is defaulted for punctuality. What should be done now?

Decision: If an eligible alternate team cannot be found who is ready to go on court by 17:20, then a walkover is awarded. 7.20 B 2) b) states that to be eligible for substitution, a lucky loser (alternate) must "be ready to play within five (5) minutes after the announcement of a default for punctuality".

ATP POLICY: While every effort must be made to locate an eligible, signed-in alternate team, the 15 minute punctuality rule must be enforced to protect the opponent who is ready to play. It is incumbent upon the teams signed-in as alternates to be available, reachable and ready to go when the match is called or within 5 minutes of the announcement of a punctuality default. In the instance of one player on court in singles, his partner must be available, reachable and ready to go, the team would be inserted and the match rescheduled. This policy extends to Lucky Losers also.

Case 2: A doubles match is called at 11:00 AM and one of the teams cannot be found. At 11:15 AM a punctuality default is awarded. How is the vacancy filled?

Decision: The highest ranked doubles team from the alternate list who are eligible to be inserted in the draw and are ready to play within the five (5) minute allotted time period will replace the defaulted team. 7.20 B 2) b) states that to be eligible for substitution, a lucky loser (alternate) must "be ready to play within five (5) minutes after the announcement of a default for punctuality".

ATP POLICY: Alternates (Lucky Losers) are to be ready when called upon to fill a vacancy. By signing the daily alternate (Lucky Loser) list they are declaring that they are on-site and ready to play, if needed. While every effort will be made by ATP staff to locate the alternate/LL teams it is the alternate/lucky loser teams/players responsibility to keep ATP staff informed of their whereabouts and to remove their names if they leave the site or otherwise become unavailable for substitution.

Advance Entry Qualifying

Case: How are vacancies handled for ATP Tour qualifying events if there are no eligible players remaining on the Advanced Entry list and there are not enough players who signed the Friday On Site Alternate list to fill the draw?

Decision: If there are no eligible players remaining on the Advanced Entry list and there are not enough players who signed the Friday On Site Alternate list to fill the draw then Byes should be awarded to the seeded players by ranking order. Any additional vacancies occurring after the draw will be filled from the "day of" Alternate sign-in list.

VII. THE COMPETITION

ATP 500 Doubles Qualifying

Case: How are vacancies handled for ATP Tour 500 doubles qualifying if there are not enough teams who entered the Qualifying Entry list or through the On-line On-site entry method to fill the draw?

Decision: If there are not enough teams who signed the Qualifying Alternate list to fill the draw then Byes should be awarded to the seeded teams by ranking order. Any additional doubles Qualifying vacancies occurring after the draw will be filled from the "day of" Alternate sign-in list.

B. Lucky Loser/Alternate Substitution

- 1) A lucky loser/alternate shall be inserted in the appropriate position as a substitution for any player who withdraws or is withdrawn before the first ball of his first match is struck.

NOTE: A player winning a match by walkover is considered to have played a match.

- 2) In order to be eligible for substitution, a lucky loser/alternate must:
 - a) Sign the lucky loser/alternate sign-in record at least one-half (1/2) hour prior to the first scheduled match of each day; and
 - b) Be ready to play within five (5) minutes after the announcement of a default for punctuality.
 - c) If the eligible lucky loser/alternate is not available to play, he shall be placed at the bottom of the lucky loser/alternate priority list for that day corresponding to the qualifying round in which he lost. If the eligible player is playing in the doubles event at the time he is called as a lucky loser/alternate in singles, the singles match may be rescheduled so he can fill the lucky loser/alternate position, provided the Supervisor determines that the rescheduling does not cause an unreasonable disruption of the schedule or does not cause the winner to play a second match that day; otherwise the next available lucky loser/alternate shall be selected to fill such vacancy.

Alternate Sign-In Procedures

Case: The two (2) players ahead on an alternate list do not sign in 1/2 hour before the singles qualifying matches are to begin. One (1) of the players arrives on-site just before it is known that an alternate is going to be needed. Who gets in?

Decision: Neither of the two (2) players. In order to be eligible for substitution, an alternate must sign in before the deadline and must be ready to play within five (5) minutes of being called.

Doubles Alternate at two tournaments?

Case: A team signs in for doubles at two tournaments the same week. They do not get into the main draw, but are the #1 alternate at both events. The team signs the Alternate list at tournament A on Monday and Tuesday and then wants to sign the Alternate list at tournament B on Wednesday. Are they permitted to do this?

Decision: Yes, however, a team is only eligible to be signed in on one "live" list per day.

VII. THE COMPETITION

Eligible for Lucky Loser - ATP Tour

Case: May a player or team sign the lucky loser sign-in sheet if they are not accepted into the qualifying competition?

Decision: No. To be eligible as a lucky loser, a player or team must have played and lost in the qualifying event.

Extending Closing Times

Case: The first-round singles matches are scheduled to start at 10 a.m. A steady rain is falling at 9 a.m. and it is decided to postpone the start of play until 11 a.m. should the lucky loser sign-in be extended?

Decision: Yes. Extend the deadline to 10:30 a.m.

Case: The lucky loser Sign-in closed at 10:30. A player arrives at 10:45 to sign in saying that:

1. The Referee told me that the deadline would be at 11:00; or
2. Somebody on the phone said the deadline was 11:00; or
3. Tournament transportation was 45 minutes late.

Decision:

1. Allow the player to sign in. Information given by the Referee (if verified) must be honored.
2. Sign-in not allowed. Players receiving information over the phone do so at their own risk unless they speak directly to the Supervisor or Referee.
3. Sign-in not allowed. The player is responsible for arriving on time.

Which Lucky Loser to Insert?

Case: On Monday before the last singles match has gone on court, a player whose first-round singles match is scheduled for Tuesday is forced to withdraw because of injury. No one signed the lucky loser list on Monday. How is the vacancy resolved?

Decision: The vacancy should be filled from Monday's lucky loser list. However, since no one signed the lucky loser list on Monday, the vacancy shall be filled from the Tuesday lucky loser list, if any eligible players sign in. If no one signs on Tuesday, then a walkover shall be awarded.

Who Goes In?

Case: A player withdraws from the singles event on Tuesday. His singles match was not scheduled until Wednesday. There was a singles lucky loser sign-in on Tuesday. The last singles match scheduled for Tuesday has not gone on court. Is the vacancy filled from Tuesday or Wednesday's lucky loser sign-in?

Decision: Tuesday's sign-in.

C. Vacancies - Doubles

ATP Tour

- 1) A team shall constitute a doubles entry. If either of the players of a team cannot play, that doubles entry is subject to withdrawal and substitution.

VII. THE COMPETITION

- 2) If the withdrawal is from the advance acceptance list and prior to 10 AM (EST) on the Friday before the event, then the next team on the alternate list is moved into the main draw.*

*Exception - If a player has to withdraw based on a medical reason or other unavoidable circumstances after the entry deadline, but prior to 10 AM (EST) on the Friday before the event, his partner may enter again and re-pair with another player who has not already been accepted into the doubles event, and this new team may be considered for acceptance based on its position in the entry list including any entry protection position (the re-pairing team must have a combined entry ranking better than the first alternate team to remain as a Direct Acceptance).

- If the new combined entry ranking is worse than the first alternate team, the new team will lose their Direct Acceptance position and be placed on the Alternate List as per their new combined entry ranking.
- If a team is re-pairing on the Alternate List, and the new combined entry ranking is BETTER than the alternates above them, they will keep their original position on the list and NOT move up on the Alternate list.
- If a team is re-pairing on the Alternate List, and the new combined entry ranking is WORSE than the alternates below them, they WILL move down on the Alternate List.

The re-pairing team entry must be received prior to the withdrawal deadline by a player relations staff member or the ATP Supervisor. If the entry is not received by the deadline, the team will be withdrawn and the list will drop to the next active team, which will be considered committed at that point.

Players are allowed to use the re-pair option up to 4 times per a calendar year.

- 3) If the withdrawal is from the advance acceptance list and occurs after the 10 AM (EST) deadline on the Friday before the event then an additional on-site entry position is created for each withdrawal.
- a) For both 2 and 3 above, the partner of the withdrawing player may enter doubles or sign in for the singles qualifying of the same or another event through the on-site entry method; or
 - b) If the withdrawal was due to one or both players being accepted into the main draw singles of another ATP Tour or ATP Challenger Tour event, then both players may enter the doubles of that event through the appropriate on-site entry procedure.
- 4) If a player from a team that is a direct acceptance withdraws based on a medical reason or other unavoidable circumstances after the on-site sign-in deadline, his partner may enter as an on-site alternate with another player who has not already been accepted into the main draw doubles event. This new team may be considered for acceptance based on its position in the on-site entry list including any entry protection position, as specified in 7.20 A. 6) b).

Can I Sign In For Q's after Withdrawing from Doubles?

Case: A player is withdrawing from a Doubles Advanced Entry list where he is a direct acceptance. Can he sign in for the singles qualifying of another ATP or Challenger tournament that same week or play doubles somewhere else?

VII. THE COMPETITION

Decision: No. However, his partner, who was not the reason for the withdrawal, can sign in for singles qualifying or find another partner and sign-in on-site for doubles at the same or another tournament.

Can I Withdraw from Doubles to Accept a Singles Wild Card?

Case: A player, who is main draw in doubles, is offered a singles wild card into an ATP Tour or ATP Challenger Tour event. Can he withdraw from main draw doubles to accept this singles wild card at another event?

Decision: Yes. The player can withdraw from the doubles before the doubles on-site entry deadline to accept a wild card into the singles. This would be considered the same as the player being accepted into the main draw singles of another ATP Tour or ATP Challenger Tour tournament which is allowed.

Partner Injured: Who May Replace Him?

Case: A player's doubles partner withdraws after the on-site sign-in deadline but before the draw is made. In looking for a new partner, is the withdrawing player's partner allowed to choose another partner from the qualifying draw?

Decision: No. The player seeking a new partner may not team with any player who is accepted into the qualifying or main doubles draws. He may re-enter with any player that he chooses as long as their combined position in the Pepperstone ATP Rankings qualifies them by virtue of the system of merit for doubles entries. He may not select from players who will be or who are in the qualifying draw based on the sign-in sheet.

ATP Challenger Tour

- 1) A team shall constitute a doubles entry. If either of the players of a team cannot play, that doubles entry is subject to withdrawal and substitution.
- 2) If a player from a team that is a direct acceptance in the main draw withdraws based on a medical reason or other unavoidable circumstances after the on-site sign-in deadline but before the draw, his partner may enter again with another player who has not already been accepted into the main draw doubles event. This new team may be considered for acceptance based on its position in the entry list including any entry protection position.

Remake of the Draw

Case: On Monday morning, two (2) of the four (4) seeded teams withdraw from a 16-draw doubles event. The doubles competition has not yet begun. May the draw be remade?

Decision: Yes. However, it is the option of the tournament.

D. Prior to Qualifying Competition

- 1) **ATP Tour Singles.** After the main draw is made and prior to the commencement of the qualifying competition, all vacancies created by the withdrawal of unseeded players including wild card withdrawals, shall be filled by the next highest positioned player(s) on the original acceptance list. If the vacancy was created by the withdrawal of a seed, then the procedures for replacing seeds are followed and the vacancy created by replacing the seed is filled by the next highest positioned player(s) on the original acceptance list.

VII. THE COMPETITION

- 2) **ATP Tour Doubles.** After the main draw is made and prior to the commencement of the qualifying competition, all vacancies created by the withdrawal of unseeded teams including wild card withdrawals, shall be filled by the next highest positioned player(s) on the on-site entry list. If the vacancy was created by the withdrawal of a seed, then the procedures for replacing seeds are followed and the vacancy created by replacing the seed is filled by the next highest positioned player(s) on the on-site entry list.
- 3) **ATP Challenger Tour.** After the withdrawal deadline and prior to the start of Qualifying, vacancies will be filled in ranking order from the original main draw acceptance list by players who have preserved their position on the list. Players from the main draw alternate list who are directly accepted into qualifying are considered to have preserved their eligibility. A player can only preserve his eligibility on one list. If there are no Alternates from the original main draw acceptance list who have preserved eligibility, the vacancy will be filled by the highest ranked player from the qualifying or alternate list using the Pepperstone ATP Rankings, and then the Pepperstone ATP Doubles Rankings, used for seeding.

If the vacancy was created by the withdrawal of a seed, then the procedures for replacing seeds are followed and the vacancy created by replacing the seed is filled by the next highest positioned player(s) from that event's alternate sign-in list, following the protocol specified above.

ATP Tour Main Draw Vacancy Before Qualifying Starts

Case: After making the qualifying draw, a vacancy occurs in the main draw. How is the vacancy filled?

Decision: If the qualifying competition has begun, the vacancy is filled by the eligible lucky loser. If the qualifying competition has not begun, the vacancy is filled by the next player on the original acceptance list.

E. Qualifying started or finished

- 1) **During Qualifying Competition.** If a lucky loser position should become available during the qualifying competition, it shall be treated the same as the qualifying places for placement in the main draw. If a seeded player or team withdraws after the main draw has been made but prior to the release of the order of play for the first day of main draw in that event, the vacancy created by the withdrawal of a seed shall be filled by the following method:
 - a) **32/48/64/96 Singles Draw and 16/24/32 Doubles Draws.** The vacancy shall be filled by the next highest positioned player or team in the main draw eligible to be seeded. The appropriate lucky loser shall fill the remaining vacancy.
 - b) **28 Draw.** If the vacancy involves a seed #1-4, then seed #5 moves to the vacated seed position and the next highest positioned player in the main draw eligible to be seeded shall be placed in the position vacated by the #5 seed. The appropriate lucky loser shall fill the remaining vacancy. If the vacancy involves a seed #5-8, then the next highest positioned player in the main draw eligible to be seeded shall be placed in the vacated seed position. The appropriate lucky loser shall fill the remaining vacancy.
 - c) **56 Draw.** If the vacancy involves a seed #1-8, then seed #9 moves to the vacated seed position and the next highest positioned player or team in the main draw eligible to be seeded shall be placed in the position vacated by the #9 seed. The appropriate lucky loser shall fill the remaining vacancy. If

VII. THE COMPETITION

the vacancy involves a seed #9-16, then the next highest positioned player or team in the main draw eligible to be seeded shall be placed in the vacated seed position. The appropriate lucky loser shall fill the remaining vacancy.

Seeds Withdraw or Are Withdrawn

Case: The team seeded 4th withdraws after the draw but prior to the order of play being released for the first day of main draw. How is the vacancy filled?

Decision: For a 16 team draw, the vacancy created by the removal of a seeded team is filled by the next highest positioned team eligible to be seeded. The appropriate alternate or lucky loser team shall fill the remaining vacancy.

Qualifier Eligible To Be Seeded

Case: A qualifier's ranking was high enough for him to be seeded in the main draw. The main draw was completed prior to the end of the qualifying event. After the player had qualified but prior to the order of play being released for the first day of main draw a seeded player withdraws. Is the qualifier eligible to be seeded?

Decision: Yes. The successful qualifier shall be accorded the same right to be seeded as the other players who have gained entry as Direct Acceptances, Wild Cards, Special Exempt etc. As per ATP rules a player may not use his Protected Ranking for seed purposes

2) Other Vacancy Procedures After Qualifying Starts.

- a) After the qualifying commences (when the first ball of the first match is struck), vacancies may only be filled by eligible lucky losers (and eligible alternates in the case of a Challenger event).
- b) If a lucky loser position becomes available after the places for qualifiers are drawn for the main draw but before the first day of the main draw event, the highest positioned lucky loser shall be inserted into the draw provided he can be notified.
- c) If a position becomes available during the day, the highest positioned player who has signed that day's lucky loser sign-in record shall be inserted at the time the withdrawal is confirmed.
- d) Positions becoming available after the start of play for the last match of each day in that event (singles or doubles) shall be filled by the highest positioned player who signs the lucky loser sign-in record on the successive day of play.
- e) When two or more positions become available at the same time, the positions to be occupied by each lucky loser shall be determined by drawing.
- f) In all such cases, the Supervisor is responsible to notify a player(s) that he is in the draw.

When is the withdrawn player replaced?

Case: A player withdraws from the main draw 2 hours prior to the close of the lucky loser sign-in deadline. A few minutes later, the highest ranked lucky loser signs in. There is still one hour left before the lucky loser sign-in deadline closes. As the player who signed-in is the highest ranked LL, is he inserted at that moment, or is the vacancy filled after the sign-in deadline passes?

Decision: The player is not inserted in the draw until after the sign-in deadline as others may withdraw necessitating drawing for the available spots. Multiple withdrawals occurring after the last match

VII. THE COMPETITION

of that event began on the previous day, and the time that the sign-in deadline closes on the next day, are considered to have occurred at the same time and the positions to be occupied by each lucky loser shall be determined by drawing.

7.21 Match Scheduling

A. Scheduling Committee

The scheduling of matches and daily order of play in all tournaments shall be prepared by the Referee and/or Tour Manager and approved by a committee composed of the Tournament Director, Supervisor, Referee and the Tour Manager. In cases where the scheduling committee cannot agree, the Supervisor shall make the final decision.

B. Tournament Week Plan

- 1) **Main Draw.** The main draw should be scheduled so that the first round in singles begins on Monday and the finals in singles and doubles are completed by Sunday, unless the tournament has special permission from ATP forty-two (42) days in advance of the event to complete the tournament on Saturday or on Monday.
 - a) **Considerations and Priorities.** The following priorities in the order listed should be followed:
 - i) Schedule the halves of the draw together particularly from Wednesday onward. At indoor tournaments, second rounds can be split within sections if necessary to avoid Monday/Thursday (singles).
 - ii) Schedule quarters together as an alternative.
 - iii) Avoid Monday/Thursday (singles) or Tuesday/Friday (doubles). Schedule some doubles on Monday.
 - iv) The singles quarterfinal matches on Friday should be scheduled by halves and as close together as possible.
 - v) Schedule one doubles semi-final on Friday (cannot be done if there are two Saturday sessions).
 - vi) When weather or other unavoidable circumstances cause a disruption in the schedule, a player may not be scheduled for more than three (3) matches in a day without his consent.
 1. The matches may not all be singles without the consent of the player.
 2. Completion of a match in progress shall count as one (1) match.
- 2) **ATP Tour Qualifying.** One (1) round per day except when weather or other unavoidable circumstances require two (2) rounds to be played on the same day.
 - a) In ATP Tour events, one round shall be played on Saturday and the final round shall be played on Sunday except when weather or other unavoidable circumstances forces two rounds to be played on Sunday.
 - b) In ATP Tour 250 events, one round shall be played on Sunday and the final round shall be played on Monday except when weather or other unavoidable circumstances forces two rounds to be played on Monday.

ATP Tour 250 events may elect and will be approved for qualifying to be held on Saturday and Sunday. A notification for Saturday – Sunday qualifying must be submitted in writing by the tournament and received by the appropriate ATP regional office no later than six (6) months prior to the first Monday of the event.

VII. THE COMPETITION

3) ATP Challenger Tour Qualifying.

- i) **ATP Challenger 75-125.** The two (2) qualifying singles matches shall be scheduled as first matches on the first day of the event, no exceptions.
- ii) **ATP Challenger 50.** The Qualifying shall be played over the first two (2) days of the tournament week. The final round, six (6) matches should be scheduled as a first priority on the second day.

C. Daily Scheduling Overview

- 1) Feature singles matches should be scheduled after the scheduling committee considers the needs of players, television, tournament and the public. It is recommended that a tournament schedule no more than two (2) evening matches to begin no later than 8 p.m. local time.
- 2) The scheduling committee must schedule a doubles match on all show courts (including Center Court) as follows:

ATP Tour 250 (16 draw doubles)

- o Seven (7) doubles matches must be scheduled on the Center Court during the tournament week.

ATP Tour 250 (24 draw doubles)

- o Seven (7) doubles matches must be scheduled on the Center Court during the tournament week.
- o Four (4) doubles matches must be scheduled on the Grandstand or second court.

ATP Tour 500 (16 draw doubles)

- o Seven (7) doubles matches must be scheduled on the Center Court during the tournament week.

ATP Tour 500 (24 draw doubles)

- o Seven (7) doubles matches must be scheduled on the Center Court during the tournament week.
- o Four (4) doubles matches must be scheduled on the Grandstand or second court.

ATP Tour Masters 1000 (24 draw doubles)

- o Seven (7) doubles matches must be scheduled on the Center Court during the tournament week.
- o Seven (7) doubles matches must be scheduled on the next two (2) best courts with at least four (4) out of the seven (7) scheduled on the second overall best court.

ATP Tour Masters 1000 (32 draw doubles)

- o Seven (7) doubles matches must be scheduled on the Center Court during the tournament week.
- o Nine (9) doubles matches must be scheduled on the next two (2) best courts with at least four (4) out of the nine (9) scheduled on the second overall best court.

Final. The doubles final is to be scheduled prior to the singles final. It is recommended that the time of the final is no earlier than two (2) hours before the singles final, unless otherwise approved by ATP.

It is further recommended that the tournament begin each session (day and night) with a doubles match as an “opening act”.

If exceptional circumstances do not allow for a doubles match to be scheduled on the Center Court or a designated show court, then best efforts shall be made by the scheduling committee to schedule an additional doubles match on one of the other show courts, if any.

VII. THE COMPETITION

- a) **Exceptional Circumstances may include, but are not limited to, the following:**
- i) Contractual television obligations.
 - ii) Security issues.
 - iii) Weather or other scheduling interruptions.
 - iv) Combined with WTA Tour event.
 - v) Unforeseen circumstances as determined by the scheduling committee.

Definition of show court(s): Center Court and all other courts that are used to televise matches; or, if only Center Court is televised, then the next court with the greatest number of spectator seating.

Violation of this section may subject the Tournament to the penalties set forth in VIII. The Code - section 8.02 Tournament Violations.

- 3) Normally, matches are scheduled using “to follow on assigned court.” However, assigning feature matches a time or “not before” basis is permissible. The Tournament Director should understand that scheduling “not before” in a Center or show courts may result in a court not having a match until the announced time.
- 4) First round doubles matches can be scheduled on a “not before” basis which will then allow for the fixing of the lucky loser or alternate sign-in deadline.
- 5) Starting matches after Midnight is not recommended (after 1:00 a.m. should be avoided). The ATP Supervisor may postpone a match after examining the impact on the tournament and the players. If postponing the match is not possible, then consideration must be given to moving a match to another court, if available.

D. Order of Play

The daily order of play is the published summary of all matches scheduled for a particular day.

- 1) **Release Deadline.** Once the scheduling committee determines the order of play, it should be released no later than 10 p.m. local time at the tournament.
- 2) **Change.** Once released, the order of play may not be changed except upon the approval of the Supervisor.
- 3) **Notification.**
 - a) It is the responsibility of all players to ascertain their schedules from the Supervisor/Referee for each day's play.
 - b) The Supervisor/Referee should also use all available means to notify each player of his schedule.
- 4) **Notes / Reminders.** Daily order of play must have footnotes reflecting the following:
 - a) The singles (and doubles) lucky loser sign-in deadline is _____(on appropriate days).
 - b) The alternate sign-in deadline is _____(on appropriate days).
 - c) Any match on any court or session may be moved.

E. Calling of Matches

The Supervisor determines when a match is to be called. Players must be ready to play when their matches are called. The Supervisor shall determine when a match is to be called or when a match was in fact called. Schedules and match updates may only be reliably obtained from the Supervisor, Tour Manager or the Referee.

VII. THE COMPETITION

F. Rain

If because of rain, etc., a tournament cannot be completed within the tournament week, then, at the option of the tournament, one (1) extra day shall be allowed. The Supervisor shall approve the commencement times for matches on the extra day, which shall then be scheduled during the morning or early afternoon. No further extension of the tournament shall be permitted without the approval of ATP.

Case: *A tournament with an approved and announced Saturday final is interrupted by weather so that the final is scheduled for Sunday. If adverse weather on Sunday prevents the match from being played, may the tournament be extended to Monday at the option of the tournament?*

Decision: *No. For a tournament with a Saturday final the tournament week would end on Saturday and the one (1) extra day allowed at the option of the tournament would be Sunday. It must be noted however that if play cannot be completed on Sunday then ATP would consider approving Monday play only in the case where all parties (tournament & all players) request to finish on Monday.*

G. Rest Periods - Minimums and Guidelines

- 1) **Between Main Draw and Prior Week's Tournament(s).** Before scheduling matches for the first day of play, the Supervisor must contact the Supervisor(s), Referee(s) or Tour Manager(s) of the preceding week's tournament(s) to determine to what extent players still competing may have difficulties in arriving for play. To the extent possible, and providing it does not jeopardize the fairness of scheduling and the completion of his tournament, matches should be scheduled so that each player with reasonable difficulties can be accommodated. The Supervisor shall whenever possible give the player one full day's rest between his last match played in a previous week's tournament or event and the player's first match in the succeeding tournament, unless weather or unavoidable circumstances have caused a schedule disruption or the player was a finalist in a Monday or other delayed final. There shall be no first-round singles matches scheduled to start on Wednesday in 32 draw outdoor tournaments without the approval of ATP or on-site Supervisor. The on-site Supervisor shall consider approving Wednesday starts only in the following circumstances:
 - a) If a player is competing on the Sunday in a Grand Slam, ATP Tour, ATP Challenger Tour, Davis Cup or ITF M 25 tournament, and the following week's tournament is on a different continent; or in a Monday Final on the same continent. Davis Cup Ties on the same continent which are delayed until Monday may also be considered. For the purposes of this rule the world is divided into 7 distinct continents. They are Europe, Asia, Antarctica, Australia, Africa, North America (including Central America) and South America. In such cases, the match must be scheduled early Wednesday and if the player enters doubles, then he shall be required to play as determined by the Supervisor.

The criteria listed in a) above shall not apply in the case where a tournament has been approved for a Saturday final.

Case: *A player competes in a Grand Slam Junior match on the final Sunday. Is he eligible for a Wednesday start if his next tournament is the following week and on a different continent?*

VII. THE COMPETITION

Decision: No. The Wednesday start provisions indicated in the ATP Rulebook only apply to Main Draw Singles, Main Draw Doubles and Mixed Doubles.

2) **Main Draw and Qualifying.** Other than in exceptional circumstances, no player shall be required to play his first-round match in the singles main draw until at least twelve (12) hours after the completion of his final qualifying match. The following should also be considered:

- a) If a player plays two (2) rounds of singles qualifying on the first day of qualifying, then the scheduled start time of his final round of qualifying shall be no earlier than eighteen (18) hours from the start time of his second qualifying match.
- b) If a player plays in two (2) singles qualifying matches on Sunday, then he shall not be scheduled to play in a singles main draw match on Monday. However, the player may be scheduled to play, if necessary, a doubles match on Monday.
- c) If a player plays in two (2) doubles qualifying matches on Sunday, then he can be scheduled to play in either one (1) singles or one (1) doubles main draw match on Monday.
- d) If a player plays in one (1) singles qualifying and two (2) doubles qualifying matches on Sunday, then he shall not be scheduled to play on Monday.
- e) If a player plays in one (1) singles qualifying and one (1) doubles qualifying match on Sunday, then he can be scheduled to play in one (1) singles main draw match on Monday. The singles match is to be scheduled early if that player is also playing in a doubles qualifying match (final) on that Monday.
- f) If the final doubles qualifying match is scheduled for Monday, the main draw doubles matches shall be scheduled no earlier than three (3) hours after the final qualifying match. If the main draw doubles match should be scheduled earlier, then it is understood that if a doubles lucky loser is required, the match shall be re-scheduled with that lucky loser inserted.
- g) Any player who becomes a lucky loser may be scheduled to play on Monday regardless of the number of matches that he has competed in on Sunday. Except, however, a player who played in three (3) matches on Sunday may only play one (1) match (singles) on Monday. If the player is to be required to be a doubles lucky loser or is scheduled to play a main draw doubles match, the doubles match would be rescheduled when his team is inserted into the draw unless the Supervisor determines the schedule shall be adversely affected.

Case: Due to weather or other unforeseen circumstances, a player played two singles qualifying matches on Monday in an outdoor tournament. May he be scheduled for a main draw singles match on Tuesday?

Decision: Yes. The provision of not playing on Monday after playing two qualifying matches on Sunday does not apply as there are no Wednesday starts permitted.

3) **Between Main Draw Matches.**

- a) Players shall not be scheduled to play in a match within twelve (12) hours after completing his last match the preceding day.
- b) Players shall not be scheduled for more than one (1) singles and one (1) doubles match per day, unless weather or other unavoidable circumstances have caused schedule disruptions. Completion of a match in progress shall count as one (1) match.

VII. THE COMPETITION

- c) A player's singles match on any particular day shall be scheduled before his doubles match(es) unless otherwise directed by the Supervisor. Even without a schedule disruption, a player may be scheduled for two (2) doubles matches if he is not scheduled to play in singles that day.
- d) Whenever it is necessary to schedule a player to compete in more than one match in the same day, a player shall be given the following minimum rest periods (other factors may result in more time being authorized) unless he is in a singles and doubles finals to be played consecutively:

- | | <u>Outdoor</u> | <u>Indoor</u> |
|---|----------------|---------------|
| i) If he has played less than 1 hour | 30 min. rest | 30 min. rest |
| ii) If he has played between 1 and 1/2 hours | 1 hr. rest | 45 min. rest |
| iii) If he has played for more than 1 1/2 hours | 1 1/2 hr. rest | 1 hr. rest |
- iv) If play has been interrupted for thirty (30) minutes or more because of rain or other warranted delay, the length of match time would be assessed from the moment play resumes after the delay.
- v) If play is interrupted for less than thirty (30) minutes, match time would be considered continuous from the moment the first ball of the match was put into play.

- e) Whenever it is necessary for a player to compete in two (2) singles matches in the same day, other than in exceptional circumstances a player shall be scheduled the following day no earlier than eighteen (18) hours from the start of his last match of the previous day, singles or doubles.

4) **Between Singles Semi-final and Singles Final**

- a) When the two (2) semi-final matches are not to be played consecutively, then the scheduled start time of the final shall be no earlier than eighteen (18) hours from the scheduled start time of the second semi-final match. In the case where the two (2) semi-final matches are to be played consecutively (i.e. "followed-by"), then the scheduled start time of the final shall be no earlier than twenty (20) hours from the scheduled start time of the first semi-final match.
- b) Tournaments are encouraged to plan the schedule so that it exceeds the minimum requirement.
- c) If rain or other unavoidable circumstances have caused a disruption in the schedule, then after considering the interests of the tournament, the players, the television and the public, the Supervisor shall determine the revised time of the semi-final and/or the final.

Player Entitled to Minimum Rest

Case: Because of rain delays, the singles semi-final and final matches are scheduled for Sunday. The two (2) semi-final singles matches are played on two (2) courts starting at 10 a.m. The final, because of television commitments, is scheduled to begin at 2 p.m. with live television coverage. One of the semi-final matches does not finish until 1:15 p.m. The tournament and the television staff still insist that the final match begin at 2 p.m. What is the solution?

Decision: The player is entitled to a minimum rest of 1 1/2 hours. The final cannot start before 2:45 p.m.

Note: In circumstances where television is a factor, the Supervisor should try to give as much flexibility as possible by starting the semi-final matches as early as possible. Also, it is important to know the latest start time acceptable for television. The goal is to give the

VII. THE COMPETITION

players more than their minimum rest time between a semi-final and final.

Rain: How Many Matches Per Player?

Case: Rain has put the tournament behind schedule. Player A's singles match was suspended at one set all. Player A is also behind in the doubles. How many matches may player A be scheduled to play the next day?

Decision: Three (3). Completion of a match shall count as one (1) match. If the player wins the singles match in progress then he may be scheduled for one (1) more singles plus one (1) doubles. If he loses the first singles match, then he may be scheduled for two (2) doubles matches.

Scheduling Priorities

Case: In preparing the schedule of play for Wednesday in a 32-draw outdoor event, the upper half of the draw is the half the tournament would like to play. Several players will have played singles on Monday and not again until Thursday if that half is played. Sections of the draw would have to be split to accommodate players not having two (2) days off between singles matches. What is the correct priority in scheduling?

Decision: Scheduling in outdoor events must keep sections of the draw together. Preferably, halves of the draw are scheduled together, if that is not possible then quarters are scheduled together. Players playing singles on Monday and Thursday should be avoided; however, halves of the draw should be kept together. Inclement weather can adversely affect the schedule as well as the fair treatment of the players unless these priorities are followed.

Rain Delayed Semi-final, When to Play Final?

Case: Rain on Saturday prevents both semi-final singles from being played. The second semi-final is played on Sunday morning, with the winner due to play the final that afternoon. Can the winner of the second semi-final insist on a Monday final?

Decision: No. Every effort must be made to finish the tournament on Sunday. The winner of the second semi-final should be given the maximum amount of rest possible before playing the final. (ATP Policy)

Moving Indoors at an Outdoor event

Case: Rain has disrupted play to the point where the event is in danger of not being completed. There are indoor courts available for use. May the Supervisor move the matches indoors to complete this event?

Decision: Yes. Under the responsibilities of the Supervisor it states that "the Supervisor may, if necessary to eliminate the possibility of a player having to play two singles matches in one day, or if necessary to complete the event, move a match to another court, indoors or outdoors, regardless of surface". The exception to this is if the Tournament Director demonstrates to the Supervisor that there will be a detrimental impact on the success of the tournament if singles or doubles matches are played indoors. In this case, the Supervisor may elect to keep all matches for outdoor play. (ATP Policy)

VII. THE COMPETITION

7.22 On-Court Procedures and Requirements

A. Start of Tournament

A tournament shall commence when the first serve of the first point of the first match is struck.

B. Start of Match

A match shall commence when the first serve of the first point is struck.

C. Rules of Tennis

The Rules of Tennis shall apply to all ATP Tour and ATP Challenger Tour tournaments except as amended by the ATP Official Rulebook.

D. Appeal of Calls

1) Questions of Fact.

- a) **Definition.** A question of fact is defined as an issue relating to what actually occurred on court during a specific match. Only the on-court officials shall determine questions of fact arising during a match and the player or the Supervisor may not change such determinations.
- b) **Rule.** A player may not appeal the determination made by the on-court officials on a question of fact.

2) Questions of Tennis Law.

- a) **Definition.** A question of tennis law is defined as an issue relating to the construction and application of specific facts to the ATP rules and regulations and the rules of tennis. During a match, the Chair Umpire shall first determine questions of tennis law. If the Chair Umpire is uncertain or if a player appeals the determination of the Chair Umpire, then the decision shall be made by the Supervisor, which shall be final and non-appealable.
- b) **Player Rights.** A player shall have the right to appeal any ruling of tennis law in accordance with the following procedures:
 - i) When a player is of the opinion that a ruling by the Chair Umpire on a matter of tennis law is erroneous, he may appeal the ruling by notification to the Chair Umpire in a professional and non-abusive manner.
 - ii) The Chair Umpire shall stop play and immediately call for the Supervisor. Upon the arrival of the Supervisor, the Chair Umpire shall state the facts of the incident and the Supervisor shall be bound by the facts as stated. The Chair Umpire shall then state his position with respect to the ruling. The Supervisor shall review briefly the applicable rules with the player and the Chair Umpire and either affirm or reverse the ruling.
 - iii) Play shall be resumed upon the statement of "Let's Play" by the Supervisor and the players must proceed to commence play and the twenty-five (25) second clock shall commence.

E. Tennis Law - Cases

Appeal of Judgment Calls

Case: A first serve is hit down the middle and is called out and then corrected to good by the center service Line Umpire. The Chair Umpire awards the point to the server, but the receiver disagrees

VII. THE COMPETITION

saying that he had a play on the ball. The Chair Umpire agrees and rules that the point be replayed. The Supervisor is called to the court.

Decision: Point to server. The Chair Umpire may not change a judgment decision after a player appeal.

Appeal of the “Facts”: Receiver

Case: First point of a game, the first serve is called fault and overruled by the Chair Umpire to good. The Chair Umpire then announces 15-Love. The receiver states that the point should be re-played because he returned the ball into the court. The Chair Umpire realizes that the receiver did in fact return the ball and orders the point to be replayed. The server claims that the Chair Umpire cannot change his decision and asks for the Supervisor to be called.

Decision: The point is re-played. The Chair Umpire’s initial awarding of the point to the server was incorrect based upon the facts as described by the Chair Umpire: The receiver did return the serve.

Appeal of the “Facts”: Server

Case: First point of a game, the first serve is called fault and overruled by the Chair Umpire to good. The Chair Umpire awards the point to the server based upon his judgment that the receiver did not have a play on the ball. The receiver claims that he could have played the ball. The Chair Umpire is not sure of his original judgment and orders the point to be re-played. The server claims that the Chair Umpire may not change his judgment based upon an appeal from the receiver and asks for the Supervisor to be called.

Decision: Point to the server. The facts on which the Chair Umpire based his initial decision did not change. Therefore, the Chair Umpire may not change his original decision based upon a player’s appeal or protest.

Umpire Blocked on Question of Fact

Case: Player A stops play claiming that player B had played the ball after it had bounced twice. The Chair Umpire said that he was “blocked” and could not make the decision.

Decision: The point stands as played. When the Chair Umpire has the primary responsibility for a call (nets, throughs, not-ups and touches) as opposed to the secondary responsibility (line calls), an immediate decision must be made. If the Chair Umpire did not see a rules violation on something for which he has the primary responsibility then technically no violation can be called

Appealing for a Let

Case: Player A serves and player B returns the ball for a winner. Player A appeals to the Chair Umpire that the service was a let. The Chair Umpire says that he did not hear a let. Player A then asks player B if he heard a let. Player B answers yes. Upon hearing this, the Chair Umpire says that since both players heard a let, we shall play a let. Player B objects saying that it is the Chair Umpire’s call and that he was only confirming to player A that the Chair Umpire had made a mistake.

Decision: The point stands as played. The Chair Umpire cannot make assumptions as to the intent of player B’s comment. The

VII. THE COMPETITION

Chair Umpire should be certain that the intention of player B was to play a let before making any decision.

F. Hindrance. A hindrance may result (1) from a corrected call by an official or (2) from an inadvertent event that occurs on-court:

- 1) **Corrected Call.** Whenever there is a corrected call either by overrule, correction by a Line Umpire or otherwise, the Chair Umpire in his sole judgment must determine if either player was hindered, and if so, order a “Let” to be played.
 - a) If a call is corrected from “Good Ball” to “Out,” then the point is ended and there is no hindrance.
 - b) If the call is corrected from “Out” to “Good Ball,” then there must be a “Let” played unless it was a clear ace or a clear winning shot that the player could not possibly have retrieved. If there is any reasonable possibility that such a ball could have been played, then the player who would have lost the point must be given the benefit of the doubt.
- 2) **Inadvertent or Deliberate event.** A distraction occurring on-court may be ruled inadvertent (unintentional) or ruled deliberate.
 - a) Inadvertent distractions may include the following (a “Let” may be called in these cases): a ball rolling onto the court; a ball falling out of a pocket; a hat falling off; or an involuntary sound or exclamation (ex. verbal reaction to an injury) from a player. Any player who created the hindrance must be advised that the next time play is stopped by the Chair Umpire because of that player’s similar actions; it shall result in a loss of point.
 - b) Any distraction caused by a player may be ruled deliberate and result in the loss of a point (intentional or unintentional). Deliberate is defined as the player meant to do what it was that caused the hindrance or distraction.
 - c) Care must be exercised to ensure rulings do not result in providing a player(s) with two opportunities to win a point.

G. Hindrance Cases

Delaying the Server

Case: During a match with Review ELC in use, the receiver breaks a string after returning a first serve called fault. The server challenges the fault call and the receiver changes his racket before the result of the challenge is displayed on the screen. Should the server be awarded a first serve if the call stands?

Decision: Second serve, as the receiver changing his racket did not delay the server in any way.

Corrected Call

Case: A second serve is a “net” call. The service Line Umpire calls “out,” then corrects it to “good.”

Decision: Second serve

Opponent’s Gear Falls On The Court

Case: Clothing or equipment (excluding the racquet) that is worn or carried by a player, including a ball from his pocket, falls to the court during play.

Decision: The Chair Umpire shall call a let and replay the point. He shall also inform the player that if the Chair Umpire makes a second call of let, it will result in a loss of point.

VII. THE COMPETITION

Case: A player's shoe comes off during play and is laying on the court.

Decision: The default position of the Chair Umpire should be that the point continues, unless the Chair Umpire is convinced that the opponent is hindered and in that case, a let could be called.

Opponent Makes Noise

Case: During play, a player thinking he has hit a winner, shouts "vamos", "come on", "yes", etc. as his opponent is in the act of hitting the ball.

Decision: If the Chair Umpire rules that a hindrance has occurred then, as the sound or exclamation that caused the hindrance was deliberate, the point shall be awarded.

Inadvertent Hindrance

Case: As a player is in the process of hitting a volley into the net, his hat falls off. He then claims a let for hindrance.

Decision: No let. A player may not hinder himself. A let should only be called when the opponent could have been hindered.

Singles Stick Falls

Case: After a first serve fault, the singles stick falls to the court.

Decision: The Chair Umpire should award a first serve unless in his opinion the replacement time was such that the server was not delayed in his delivery of a second serve.

Spectator Noise

Case: During play an "out" call is made by a spectator. The player stops playing and claims hindrance.

Decision: The point stands as played.

Early Foot Fault Call

Case: The baseline umpire calls a foot fault on the server prior to him hitting a first serve. The server continues with his motion and hits the serve into the net.

Decision: First serve awarded. It is not a foot fault until the ball has been struck. Therefore, the call is erroneous and the Line Umpire has hindered the server.

H. Overrule

- 1) The Chair Umpire may overrule a Line Umpire only if (1) there is a clear mistake by a Line Umpire, and (2) the overrule is made promptly after the mistake. A player may never appeal a determination on questions of fact to the Supervisor.
 - a) **Clear Mistake.** As a matter of practice the Chair Umpire must be in a position to make a determination that a call was erroneous beyond a reasonable doubt. To overrule a ball called "Good" by the Line Umpire, the Chair Umpire must have been able to see a space between the ball and the line. To overrule an "Out" or "Fault" call by a Line Umpire, the Chair Umpire must have seen the ball hit on or inside the line. Clear foot-faults not called by the responsible Line Umpire should be called by the Chair Umpire.
 - b) **Promptly.** The Chair Umpire must overrule immediately after the Line Umpire makes the "clear mistake." The overrule "call" must be made almost simultaneously with the "clear mistake" made by the Line Umpire.

VII. THE COMPETITION

- 2) A player may request that the Chair Umpire verify a call or other determination of fact on a point-ending call made by an on-court official; upon such request the Chair Umpire shall immediately verify the same either by his own personal observation or upon confirmation of the Line Umpire or other on-court official involved. The Chair Umpire may never overrule the call of a Line Umpire upon the request of a player. A Line Umpire may never change a call as a result of a protest or appeal, except in the case of clay court ball mark procedures.
- 3) The request, verification and resumption of play should be completed within the twenty-five (25) seconds allowed between points. If the player prolongs the argument, the Chair Umpire should announce "Let's Play," and the player is subject to the provisions of the Code.

I. Correction/Verification of Call

Line umpires. When a Line Umpire realizes that he/she has made an erroneous call, including an inadvertent sound, he/she should immediately call "Correction" so that the Chair Umpire and the players are aware of the error. The Line Umpire should then make the corrected call.

J. Ball Mark Inspection Procedures (Clay Courts)

1) Chair Umpire

- a) A ball mark inspection requested by a player (team) shall be allowed only if the Chair Umpire cannot determine the call with surety on either a point-ending shot or when a player (team) stops playing the point during the rally (Returns are permitted but then the player must immediately stop). The Chair Umpire shall check ball marks if there is some doubt about the accuracy of the call.
- b) If the Chair Umpire sees a clear mistake, he may stop play with an overrule.
- c) The original call or overrule shall always stand if the Line Umpire and/or Chair Umpire cannot determine the location of the mark or if the mark is unreadable.
- d) Once the Chair Umpire has identified and ruled on a ball mark, this decision is final and not appealable.
- e) In clay court tennis, the Chair Umpire should not be too quick to announce the score unless absolutely certain of the call. If in doubt, the Chair Umpire should wait before calling the score to determine whether a ball mark inspection is necessary. Ball mark inspections made after the score has been announced or after first serves shall be done as quickly as possible so the server is not unreasonably delayed.
- f) In doubles, the appealing player must make his appeal in such a way that either both players stop playing the point or the Chair Umpire stops play. If an appeal is made to the Chair Umpire, then the Chair Umpire must first determine that the correct procedure was followed. If it is not proper or if it is late, then the Chair Umpire may determine that the opposing team was deliberately hindered.
- g) Players may not cross the net to check a ball mark without being subject to the Code. A player may not erase marks unless he is conceding the call or after a ball mark inspection occurs and the Chair Umpire has made a final decision.

VII. THE COMPETITION

2) Line Umpires

- a) If a Line Umpire has to make a close call, he must keep his eyes on the mark and should not look at the Chair Umpire.
- b) If requested by the Chair Umpire, the Line Umpire shall walk directly to the mark and identify the mark to the Chair Umpire. The Chair Umpire shall then inspect the mark and make the determination.
- c) If directed by the Chair Umpire to identify a mark and the Line Umpire is not sure of the mark, the Line Umpire must state immediately to the Chair Umpire, "I do not have the mark."

K. Clay Court Cases

Can't Find Ball Mark

Case: A Line Umpire calls a ball out on a clay court. The Chair Umpire asks him to show the mark. The Line Umpire cannot locate the mark and neither can the Chair Umpire.

Decision: The original (out) call must stand.

Clay Court: Doubles Ball Mark Appeal

Case: Player B returns a serve but his partner, player A, says, "wait" as he moves to look at the mark. The Chair Umpire stops play. The opponent, player C, appeals to the Supervisor, saying player B returned the serve, which player C put away.

Decision: The procedure was correct (The Chair Umpire stopped play after an interruption by player A.) The mark is examined and if it is good, Team A-B loses the point; otherwise, it is a second serve.

Must Both Players on a Team Stop to Get Ball Mark Inspection.

Case: In doubles on a clay court, the second serve is called good. The receiver returns the ball but hesitates in search of the mark. His partner crosses (poaches) and hits the ball into the net. The receiver then appeals the second serve, stating that he stopped play prior to his reflex return.

Decision: The point stands as played. Both players must stop playing or the player appealing must do so in a manner that results in the Chair Umpire stopping play.

Overrule Then Inspect Ball Mark

Case: As a Chair Umpire, you overrule a ball on a clay court. The player disagrees and asks for a ball mark inspection. You think that maybe you made a mistake on the overrule.

Decision: The Chair Umpire should check the mark.

L. Electronic Review / Electronic Review - Line Calling (Review ELC)

A. Electronic Review (Review ELC)

The use of an approved electronic system for reviewing line calls and/or overrules is authorized for use at ATP events. The protocol for Review ELC is as follows:

- 1) A request for an electronic review of a line call by a player (team) shall be allowed only on either a point-ending shot or when a player (team) stops playing the point during a rally (returns are permitted but then the player must immediately stop).
- 2) In doubles the appealing player must make his appeal in such a way that either play stops or the Chair Umpire stops play. If an appeal is made to the Chair

VII. THE COMPETITION

Umpire the Chair Umpire must first determine that the correct appeal procedure was followed. If it was not correct or if it was late, then the Chair Umpire may determine that the opposing team was deliberately hindered, in which case the appealing team loses the point.

- 3) Each player/team shall receive three (3) challenges per set (excluding the tie-break game). If the player/team is incorrect with a challenge, then one of the challenges is lost. If the player (team) is correct with a challenge, then the player retains his same number of challenges. Challenges remaining, if any, at the end of a set do not carry over to the next set.
- 4) During the tie-break game in any set, each player/team shall receive one (1) additional challenge. This is in addition to any challenges not lost, if any, during the set.
- 5) For doubles, the Match Tie Break shall be considered as a new set and each team shall receive three (3) challenges. Challenges remaining from the previous set do not carry over into the Match Tie Break. Successful challenges do not reduce the number of challenges that may remain.
- 6) In order to challenge, a player must show an immediate interest in making a challenge and must do it in a timely manner. The key to the policy is "immediate interest". The player must also make his/her intention to challenge known to the Chair Umpire either verbally or visually using his racquet or finger. The Chair Umpire will (a) reconfirm with the player his intent to challenge; (b) confirm that the player has challenges remaining; and (c) proceed with the electronic review.
- 7) The original call or overrule will always stand if the electronic review is unable, for whatever reason, to make a decision on that line call or overrule. In this case, the player shall not have his available number of challenges reduced.
- 8) If there is no call made from the on-court officials (unsighted Line Umpire and Chair Umpire cannot make the call) on a point ending shot, the Chair Umpire may call for a review and the result of the review will not affect the remaining challenges of either player.
- 9) The decision of the electronic review is final and cannot be appealed.
- 10) A certified official, approved by the ATP Supervisor, shall act as the Review Official* and his duties shall include, but are not limited to:
 - a) Determining which impact shall be reviewed by the system.
 - b) Act as the final authority on tracking the number of challenges each player has remaining.
 - c) Monitor the system to ensure that it is functioning properly.
 - d) Notify the Chair Umpire immediately in the case of a system failure or any other condition that prohibits or brings into question the ability of the system to review a challenged call. In this case, the Chair Umpire shall immediately notify both players that review is not available until further notice.* Review official and supporting technology staff shall be located within the stadium or arena in a secured area and with an unobstructed view of the court.
- 11) For each court that is using a review system, there shall be a minimum of one (1) video board, of sufficient size, located in a position where the Chair Umpire, players and spectators may view the results of the challenge.
- 12) Review Official Protocol is described in "Exhibit T.

VII. THE COMPETITION

B. Electronic Review - Live Line Calling (Live ELC)

The use of an approved Live ELC electronic line calling system is authorized for use at ATP events in 2023.

The following protocol shall be used.

- 1) There shall be no line umpires. All lines shall be called using the Live ELC System approved by ATP to call all lines.
- 2) Foot-faults will be called by a Review Official monitoring two (2) court-level cameras placed on the baseline and on the center service line at each end of the court if available or the Chair Umpire.
- 3) In the unlikely event the Live ELC system malfunctions, play will be delayed for up until such time as the issue is corrected or 15 minutes have elapsed. If the issue is not resolved within 15 minutes the ATP Tour Supervisor will decide when and how the match will resume.
- 4) If the Live ELC system fails to make a call, the call shall be made by the Chair Umpire. If the Chair Umpire is unable to determine if the ball was in or out, then the point shall be replayed. This protocol applies only to point ending shots or in the case when a player stops play. In the case where there is no call, and the player stops play, the umpire shall call for the shot to be displayed on the video board for confirmation.
- 5) If equipment is available, automatic replays of the call will be shown on the video boards on point ending shots that are "out" by 15 centimeters or less. Winning shots warranting a replay will be manually directed to the video board by the Review Official.
- 6) Physical requirements for the on-site booth to be confirmed..

M. Continuous Play/Delay of Game

Play shall be continuous, except that a maximum of twenty-five (25) seconds may elapse from the moment the ball goes out of play at the end of one point to the time the ball is struck for the next point, except at a ninety (90) second changeover or a one hundred and twenty (120) second set break. The procedures for enforcing this rule are as follows:

- 1) **Time Between Points. 25 Seconds/Continuous Play**
 - a) **Start Stop Watch.** The Chair Umpire must start the stopwatch after the ball goes out of play or when the players are ordered to play.
 - b) **Time Violation or Code Violation.** A Time or Code Violation must be assessed if the ball is not struck for the next point within the twenty-five (25) seconds allowed, except if the Chair Umpire extends the time for special circumstances defined by ATP. There is no time warning prior to the expiration of the twenty-five (25) seconds.
- 2) **90 Seconds/Change-Over (Changing Ends)**
 - a) **Start Stop Watch.** The Chair Umpire must start the stopwatch the moment the ball goes out of play.
 - b) **"Time."** The Chair Umpire must announce to players "Time" after one (1) minute has elapsed. If requested, prior to the match, by a television broad-

VII. THE COMPETITION

caster, the Chair Umpire shall have the authority to delay the start of play until the end of the ninety (90) second changeover period.

- c) **"15 Seconds."** The Chair Umpire may announce to players "15 Seconds" if the players are still at their chairs and/or have not started toward their playing positions.
 - d) **Time Violation or Code Violation.** The Chair Umpire must assess a Time Violation or, when applicable, a Code Violation (after a medical time-out or treatment) if the ball is not struck for the next point within the ninety (90) seconds / one hundred twenty (120) seconds allowed, provided there has been no interference which prevented the Server from serving within that time or a delay by the Chair Umpire.
- 3) **120 Seconds/Set Break**
 - a) **Start Stop Watch.** The Chair Umpire must start the stopwatch the moment the ball goes out of play.
 - b) **"Time".** The Chair Umpire must announce to players "time" after 90 seconds has elapsed. If requested, prior to the match, by a television broadcaster, the Chair Umpire shall have the authority to delay the start of play until the end of the one hundred twenty (120) second set break.
 - c) **"15 Seconds."** The Chair Umpire may announce to players "15 Seconds" if the players are still at their chairs and/or have not started toward their playing positions.
 - d) **Time Violation or Code Violation.** The Chair Umpire must assess a Time Violation or, when applicable, a Code Violation (after a medical time-out or treatment) if the ball is not struck for the next point within the one hundred twenty (120) / one hundred fifty (150) seconds allowed, provided there has been no interference which prevented the server from serving within that time or a delay by the Chair Umpire.
 - 4) **Not Playing to the Reasonable Pace of the Server**
 - a) **Start Stop Watch.** The Chair Umpire must start the stopwatch when the player is ordered to play or the moment the ball goes out of play.
 - b) **Time Violation or Code Violation.** The Chair Umpire must assess a Code Violation if the receiver is employing "gamesmanship." The Chair Umpire must issue a Time Violation before the expiration of twenty-five (25) seconds if the receiver's actions delay the reasonable pace of the server.
 - 5) **Stoppage and Postponement of a Match**
 - a) The Chair Umpire may stop a match temporarily because of or conditions of the grounds or weather. Any such stoppage by a Chair Umpire must be reported immediately to the Supervisor. Once a match is stopped and until a match is postponed, the Chair Umpire must ensure that he, the players and all on-court officials remain ready to resume the match. The Supervisor makes the decision to postpone a match until a later day.
 - b) Upon stoppage or postponement by the Supervisor, the Chair Umpire shall record the time, point, game and set score, the name of the server, the side on which each player was situated and shall collect all balls in use for the match.
 - 6) **Warm up / Re-warm up.**

There shall be a four (4) minute warm-up before a match and in the case of a stopped or postponed match, the period of warm-up shall be as follows:

 - a) 0-15 minutes delay — No warm--up;

VII. THE COMPETITION

- b) more than 15 minutes but less than 30 minutes —Three (3) minutes of warm-up; and
- c) 30 or more minutes of delay — Four (4) minutes of warm-up [Five (5) minutes at Challengers].

N. Video Review (“VR”)

The use of VR to determine specific judgment calls is approved for use at events where there is Electronic Line Calling (“ELC”) and the VR system has been approved by ATP.

The protocol for use is as follows:

a) Reviewable calls

- i) Not-up – ball bounced more than once prior to contact.
- ii) Foul shot – player carries the ball on the racquet, player contacts the ball before it crosses the net, player’s racquet touches the ball while not under the control of the player.
- iii) Touch – ball touches player, or anything he is wearing or carrying (except racquet), player touches net while ball is in play.
- iv) Invasion – player touches the opponent’s court with any part of his body or his racquet while the ball is in play.
- v) Through – the ball passes through the net instead of passing over the net.
- vi) Hindrance – any decision on whether a point should be awarded, or the point should be replayed. Most common use of this would be a call corrected from out to good and whether the player had a play on the ball.
- vii) Original Call Stands – when a challenge to a line call has properly been made and the line review system is unable to make a determination, the chair umpire may review the call for clear evidence that confirms or overturns the call on the court.

viii) Foot-faults

ix) Scoring error

b) Process

- i) When a reviewable call is challenged, the VR operator will find, through the various camera angles available, the best view of the incident.
- ii) The VR operator will then send the video to a screen attached to the Chair Umpire’s chair.
- iii) The Chair Umpire will review the video and determine if there is clear evidence to support the original decision or to overturn the decision.
- iv) If there is no clear evidence, then the original decision stands.

c) Limit to Challenges

- i) Each player will be limited to three (3) incorrect challenges during the set.
- ii) If any set reaches 6-all, each player will receive one (1) additional challenge.
- iii) A review under a) vii) above shall not be recorded as a won/lost challenge.

O. Time and Equipment Cases

Crowd Movement

Case: The server is given a Time Violation for going beyond the 25 seconds that is allowed between points. The server claims that he should have been given additional time because there were some spectators taking their seats.

VII. THE COMPETITION

Decision: The Time Violation stands. The continuous play procedures shall be in effect regardless of spectator movement unless the Chair Umpire believes the movement is intended as a deliberate attempt to distract a player(s) or occurs in the designated lowest tier of seats.

Ball Person as Personal Valet

Case: A player receives a time violation from the Chair Umpire while waiting for the ball person to retrieve a towel. The player claims the ball person caused the delay.

Decision: The Time Violation stands. Toweling off between points with or without the help of a ball person is not a valid reason for delay.

Time Violation, No Play, Results in Code

Case: A player, upon hearing a Time Violation, comes to the Chair Umpire and asks “Why?” He receives an explanation followed by “Let’s Play”. The player continues his discussion and is given a Code Violation. The player appeals to the Supervisor saying he should have received a Time Violation, Point Penalty.

Decision: The Chair Umpire suspends play and calls for the Supervisor. Upon arrival, the Supervisor affirms the decision of the Chair Umpire as the player was directed to play when the Chair Umpire said “Let’s Play.”

Time Violation + 25 Seconds = Code

Case: A player receives a time violation while standing at the back fence. He does not move to play and the Chair Umpire says, “Let’s play”. After another 25 seconds elapses, what does the Chair Umpire do?

Decision: A Code Violation is announced, (and possibly an inquiry, such as, “Are you OK?”) followed by “Let’s Play”.

Two Explanations are Enough

Case: A player asks for an explanation and is given one. He then raises another point and receives another response. How long may this go on?

Decision: Normally only twice since continuous play provisions are not being complied with. After two brief responses, the Chair Umpire announces “Let’s Play” and subsequently issues a Code Violation if the ball is not in play as a result of that player’s action.

Changing Shoes

Case: May a player receive extra time on a changeover in order to change his shoes and/or socks? If yes, how many times may he do so during the course of the match?

Decision: Yes. The Chair Umpire may allow a reasonable extension of the allotted changeover time in order for a player to change his shoes and/or socks. The player should not be allowed to leave the court in this instance. The player is limited to one change per match when extra time is granted unless the provisions for “equipment out of adjustment” take precedent. In that case, the Chair Umpire has the authority to decide each request on its own merit.

VII. THE COMPETITION

Contact Lens

Case: During a match, a player requests permission to leave the court in order to put in a contact lens.

Decision: The request to leave the court is denied. Contact lenses shall not be considered as equipment out of adjustment unless the player is wearing them at the time of the incident.

Note - Every attempt should be made to assist the player so that he may put the contact lenses in during the changeover.

Time: Refusal to Play

Case: After several close calls that go against him, a player comes to his chair on the changeover and says, "I'm not playing until the Line Umpire Crew is changed". After the Chair Umpire calls "Time", the player says, "I told you I'm not playing until the Line Umpires are changed". What should the Chair Umpire do?

Decision: The Chair Umpire should order the player to play and after 25 seconds use the Point Penalty Schedule.

Re-Gripping Racquet

Case: During a change of ends, while a player is re-taping the grip of his racquet, the Chair Umpire calls time. The player walks out to the baseline still taping the grip. At the end of the 90 seconds, the player has failed to commence his serve and is still working on the grip.

Decision: The Chair Umpire issues a Time Violation. The racquet is not equipment out of adjustment and therefore the player must serve within the allotted time. (Rules of Tennis, "Rule 29".) Similarly, adjusting the position of the strings or fixing string savers is not an excuse for delaying play.

Replacing Shoes

Case: During a match, a player requests permission to leave the court area to retrieve another pair of tennis shoes. He states that he is slipping and wants to get a pair of shoes with a different sole from his locker.

Decision: The request is denied. However, the Chair Umpire should use all possible means to have the shoes retrieved and brought to the court. This is not considered "Equipment Out of Adjustment". The shoes could have been brought to the court with the player and changed on-court; however, once he has the shoes, reasonable time is allowed for the change.

Shoe Breaks

Case: A player breaks his shoe and he needs to change, but his second pair is in the locker room.

Decision: The Chair Umpire should stop play and allow the player to get shoes.

No Play After 90 Seconds

Case: A player is not ready to play after the ninety (90) second changeover (no injury involved).

Decision: A Time Violation is announced. "Let's Play" is normally added. The same applies if a player is not ready to play after the 120-second set break.

VII. THE COMPETITION

P. Toilet/Change of Attire Break

- 1) A player may be permitted to leave the court for a toilet break. A player is entitled to one (1) toilet break during a best of three set match and two (2) toilet breaks during a best of five set match. For best of five set matches one toilet break may be taken during the first three sets. The second toilet break may only be taken after the end of the third set. Toilet breaks may only be taken on a set break and can be used for no other purpose. The toilet break is limited to a maximum of three (3) minutes from the time the player enters the toilet. Players exceeding the allowed time will be penalized by back-to-back Time Violations.
 - a) For doubles, each team is entitled to a total of one (1) toilet break in all matches. If partners leave the court together, it counts as the team's authorized break.
- 2) Any time a player leaves the court for a toilet break, it is considered the authorized break regardless of whether or not the opponent has left the court.
- 3) Any toilet break taken after the warm-up has started is considered the authorized break. Additional breaks will be authorized, but will be penalized with the back-to-back Time Violations if the player is not ready within the allowed time.
- 4) Change of Attire break can only be allowed in conjunction with a Toilet Break unless provisions of "equipment out of adjustment" take precedent. In that case, the Chair Umpire has the authority to decide each request on its own merit.
 - Players will only be allowed to leave the court on a set break to change wet shorts/underwear.
 - A maximum of two minutes from the time the player enters the off court changing area/toilet will be allowed in addition to the 3 minutes per Toilet Break (to a maximum of 5 minutes in total).
 - Shirts, socks, and shoes must be changed on court.

Toilet Visit

Case: In a best of three (3) set match, a player has used his one toilet visit. The player informs the Chair Umpire that at the next changeover he would like to take another toilet visit prior to his serving.

Decision: The Chair Umpire may allow a player to leave the court but must inform the player that any delay beyond the 90 seconds will be penalized with the back-to-back Time Violations.

Toilet Visit: When Does Play Resume?

Case: After play has been paused for an authorized toilet visit, when does the "clock" start to resume play?

Decision: When the player returns to the court and has had the opportunity to retrieve his racquet, then the Chair Umpire should announce "Time". This announcement shall signal the players to resume the match.

Q. Medical

1) Medical Condition

A medical condition is a medical illness or a musculoskeletal injury that warrants medical evaluation and/or medical treatment by the Physiotherapist during the warm-up or the match.

VII. THE COMPETITION

a) Treatable Medical Conditions

- i) **Acute medical condition:** the sudden development of a medical illness or musculoskeletal injury during the warm-up or the match that requires immediate medical attention.
- ii) **Non-acute medical condition:** a medical illness or musculoskeletal injury that develops or is aggravated during the warm-up or the match and requires medical attention at the changeover or set break.

b) Non-Treatable Medical Conditions

- i) Any medical condition that cannot be treated appropriately, or that will not be improved by available medical treatment within the time allowed.
- ii) Any medical condition (inclusive of symptoms) that has not developed or has not been aggravated during the warm-up or the match.
- iii) General player fatigue.
- iv) Any medical condition requiring injections or intravenous infusions, except for diabetes, for which prior medical certification has been obtained, and for which subcutaneous injections of insulin may be administered. For the avoidance of any doubt, the use of supplemental oxygen is not permitted at any time.

2) Medical Evaluation

During the warm-up or the match, the player may request through the Chair Umpire for the Physiotherapist to evaluate him during the next change over or set break. Only in the case that a player develops an acute medical condition that necessitates an immediate stop in play may the player request through the Chair Umpire for the Physiotherapist to evaluate him immediately.

The purpose of the medical evaluation is to determine if the player has developed a treatable medical condition and, if so, to determine when medical treatment is warranted. Such evaluation should be performed within a reasonable length of time, balancing player safety on the one hand, and continuous play on the other. At the discretion of the Physiotherapist, such evaluation may be performed in conjunction with the tournament Doctor, and may be performed off-court. *

If the Physiotherapist determines that the player has a non-treatable medical condition, then the player will be advised that no medical treatment will be allowed.

* It is recognized that national laws or governmental or other binding regulations imposed upon the event by authorities outside its control may require more compulsory participation by the tournament Doctor in all decisions regarding diagnosis and treatment.

3) Medical Time-Out

A medical time-out is allowed by the Supervisor or Chair Umpire when the Physiotherapist has evaluated the player and has determined that additional time for medical treatment is required. The medical time-out takes place during a change over or set break, unless the Physiotherapist determines that the player has developed an acute medical condition that requires immediate medical treatment.

The medical time-out begins when the Physiotherapist is ready to start treatment. At the discretion of the Physiotherapist, treatment during a medical time-out may take place off-court, and may proceed in conjunction with the tournament Doctor.

The medical time-out is limited to three (3) minutes of treatment. However, at professional events with prize money of \$50,000/€43,000 or less, the Supervisor may extend the time allowed for treatment if necessary.

VII. THE COMPETITION

A player is allowed one (1) medical time-out for each distinct treatable medical condition. All clinical manifestations of heat illness shall be considered as one (1) treatable medical condition. All treatable musculoskeletal injuries that manifest as part of a kinetic chain continuum shall be considered as one (1) treatable medical condition.

A total of two (2) consecutive medical time-outs may be allowed by the Supervisor or Chair Umpire for the special circumstance in which the Physiotherapist determines that the player has developed at least two (2) distinct acute and treatable medical conditions. This may include: a medical illness in conjunction with a musculoskeletal injury; two or more acute and distinct musculoskeletal injuries. In such cases, the Physiotherapist will perform a medical evaluation for the two or more treatable medical conditions during a single evaluation, and may then determine that two consecutive medical time-outs are required.

4) Muscle Cramping

A player may receive treatment for muscle cramping only during the time allotted for changeovers and/or set breaks. Players may not receive a medical time-out for muscle cramping. In cases where there is doubt about whether the player suffers from an acute medical condition, non-acute medical condition inclusive of muscle cramping, or non-treatable medical condition, the decision of the Physiotherapist, in conjunction with the tournament Doctor, if appropriate, is final. There may be a total of two (2) full change of ends treatments for muscle cramping in a match, not necessarily consecutive.

Note: A player who has stopped play by claiming an acute medical condition, but is determined by the Physiotherapist and/or tournament Doctor to have muscle cramping, shall be instructed by the Chair Umpire to resume play immediately.

If the player cannot continue playing due to severe muscle cramping, as determined by the Physiotherapist and/or tournament Doctor, he may forfeit the point(s)/game(s) needed to get to a change of end or set-break in order to receive treatment.

If it is determined by the Chair Umpire or Supervisor that gamesmanship was involved, then a Code Violation for Unsportsmanlike Conduct could be issued.

5) Medical Treatment

A player may receive on-court medical treatment and/or supplies from the Physiotherapist and/or tournament Doctor during any changeover or set break. As a guideline, such medical treatment should be limited to two (2) changeovers/set breaks for each treatable medical condition, before or after a medical time-out, and need not be consecutive. Players may not receive medical treatment for non-treatable medical conditions.

6) Penalty

After completion of a medical time-out or medical treatment, any delay in resumption of play shall be penalized by Code Violations for Delay of Game.

Any player abuse of this medical rule will be subject to penalty in accordance with the Unsportsmanlike Conduct section of the Code of Conduct.

7) Bleeding

If a player is bleeding, the Chair Umpire must stop play as soon as possible, and the Physiotherapist should be called to the court for evaluation and treatment.

VII. THE COMPETITION

The Physiotherapist, in conjunction with the tournament Doctor if appropriate, will evaluate the source of the bleeding, and will request a medical time-out for treatment if necessary.

If requested by the Physiotherapist and/or tournament Doctor, the Supervisor or Chair Umpire may allow up to a total of five (5) minutes to assure control of the bleeding.

If blood has spilled onto the court or its immediate vicinity, play must not resume until the blood spill has been cleaned appropriately.

8) Vomiting

If a player is vomiting, the Chair Umpire must stop play if vomiting has spilled onto the court, or if the player requests medical evaluation. If the player requests medical evaluation, then the Physiotherapist should determine if the player has a treatable medical condition, and if so, whether the medical condition is acute or non-acute.

If vomiting has spilled onto the court, play must not resume until the vomit spill has been cleaned appropriately.

9) Physical Incapacity

During a match, if there is an emergency medical condition and the player involved is unable to make a request for a Physiotherapist, the Chair Umpire shall immediately call for the Physiotherapist and tournament Doctor to assist the player.

Either before or during a match, if a player is considered unable physically to compete at a professional level, or poses a significant health risk to players, officials or Tournament staff, the Physiotherapist and/or tournament Doctor should inform the Supervisor and recommend that the player is ruled unable to compete in the match to be played, or retired from the match in progress. Additionally, if the Supervisor, in consultation with the tournament Doctor, Physiotherapist, or a representative of the ATP Medical Advisory Board, determines that a player's participation in a tournament match may put the player at risk due to a life threatening or otherwise serious medical problem, the Supervisor has the authority to rule a player ineligible to compete.

The Supervisor shall use great discretion before taking this action and should base the decision on the best interests of professional tennis, as well as taking all medical advice and any other information into consideration.

When the Supervisor has ruled a player ineligible to play due to circumstances involving a life threatening or otherwise serious medical condition, the player may return to play and be deemed eligible upon receipt by ATP of a written statement from the player's personal physician concluding that the player's medical condition is sufficient to play in competition, and the Supervisor, following consultation with the tournament Doctor and/or a representative of ATP Medical Advisory Board (who may require that the player undergo additional testing and obtain a written statement clearing player to return to competition from a specialist physician), indicates that the player is eligible to play.

For retirements or withdrawals that are not deemed to be life threatening or otherwise serious medical condition, the player may subsequently compete in another event at the same tournament if the tournament Doctor determines that the player's condition has improved to the extent that the player may safely physically

VII. THE COMPETITION

perform at an appropriate level of play or no longer poses a significant health risk to players, officials or Tournament Staff, whether the same day or on a later day.

R. Medical Cases

Delayed Medical Time-Out

Case: A player has an accidental injury and asks to have a medical time-out during the next changeover. What procedure should be used for timing the treatment if the Physiotherapist arrives?

A. 30 seconds into the changeover?

B. After 60 seconds has elapsed on the changeover?

Decision A: The Physiotherapist has 3 1/2 minutes [but, as a minimum, he has three (3) minutes to treat after completing his diagnosis] to treat the player before the Chair Umpire announces "Time". The player then has 30 seconds to play, subject to the Point Penalty Schedule.

Decision B: The Chair Umpire stops the clock at 60 seconds and stops play until the Physiotherapist is ready to treat the player. The three-minute medical time-out begins, and after the Chair Umpire announces "Time", the player has 30 seconds to play or be subject to the Point Penalty Schedule.

Equipment Out of Adjustment (Knee Brace)

Case: During play, a player's knee brace becomes out of adjustment. The player requests time to repair his knee brace.

Decision: The player is allowed reasonable time to repair his knee brace without penalty. Any medical apparatus worn by a player shall be considered as equipment in regards to "Equipment Out of Adjustment".

Exceeding 90 Seconds: Code Violation

Case: If a player is receiving treatment by the Physiotherapist on a 90-second change-over, and the treatment goes over the allowed 90 seconds, what happens?

Decision: When the Chair Umpire says "Time", the player must put the ball in play within 30 seconds. Any delay after that will result in a Code Violation.

Medical Time-Out and Re-Warm-Up

Case: If eight (8) minutes elapse before the Physiotherapist arrives and treatment begins two (2) minutes later (the medical time-out begins) and is completed after another three (3) minutes, is a re-warm-up authorized?

Decision: No, a re-warm-up is not authorized.

Medical Time-Out Request Honored?

Case: A player asks for the Physiotherapist. After examination, it is determined by the Physiotherapist that the player is suffering from general fatigue that may not be improved by on-court medical treatment. What course of action should the Chair Umpire take?

Decision: The Chair Umpire announces, "Let's Play", after the Physiotherapist completes his diagnosis. Delays will be penalized in accordance with the Point Penalty Schedule. The Chair Umpire has the option to issue a Code Violation for Unsportsmanlike Conduct in unusual cases.

VII. THE COMPETITION

Medical Time-Out Starts When?

Case A: When does a medical time-out begin?

Decision A: Medical time-out begins when the Physiotherapist arrives and is ready and able to treat the player. Thus, the Physiotherapist has completed his examination/diagnosis and the medical time-out starts when the Physiotherapist begins treating the player.

Case B: A player asks to see the Physiotherapist during the middle of a game although the Chair Umpire observed no accidental injury. What should the umpire do?

Decision B: First, tell the player that you will call the Physiotherapist and he can see him at the changeover. If the player insists that he cannot continue, then stop play and call the Physiotherapist. The Physiotherapist will make the decision, upon examining the player, whether a medical time-out is needed.

Only 90 Seconds to Re-Tape

Case: A player turns his ankle, which is taped by the Physiotherapist, and then on the next changeover wants the ankle re-taped.

Decision: The Chair Umpire may authorize the re-taping which must be completed within the 90-second changeover or the Point Penalty Schedule applies.

Penalties After Medical Time-Out

Case: When is the player penalized for going over three minutes on a medical time-out?

Decision: After the Chair Umpire says "Time"; the player must put the ball in play within 30 seconds. Any delay after that will result in a Code Violation. The player is allowed the time necessary to put on shoes, socks, ankle supports, etc.

Case: A player receives treatment on a changeover or receives a Medical Time-Out. The player is then slow to resume play after "Time" has been called. What is the appropriate penalty?

Decision: The appropriate Delay of Game Penalty (Warning, Point, Game).

Case: After receiving treatment for cramping on the changeover, a player plays one or more points and then is slow to resume play. If the player goes over the allowed time, what penalty does the player receive?

Decision: The appropriate Time Violation (Warning, Point/Fault).

Re-Injury

Case: A player injures his ankle and is granted a three (3) minute medical time-out by the Physiotherapist. Five (5) games later, the player asks for another medical time-out claiming that he has re-injured the same ankle.

Decision: The Chair Umpire shall call for the Physiotherapist who shall determine upon examination whether or not a three (3) minute medical time-out is authorized.

Resuming Play After a Medical Time-Out

Case A: After an injury and a four-minute suspension (by the Chair Umpire) for the arrival of the Physiotherapist, the Physiotherapist

VII. THE COMPETITION

arrives and completes the treatment in one and 1/2 minutes. When does play resume?

Decision A: Immediately.

Case B: After a player becomes injured, the Physiotherapist treats the player in two (2) minutes. When should play resume?

Decision B: Immediately when the player and Physiotherapist are satisfied with the treatment administered, but the treatment is not to exceed three (3) minutes.

Tape Is Not "Equipment Adjustment"

Case: During play, a player requests play to be suspended in order for him to adjust the tape on his ankle.

Decision: Play must continue. Taping is not considered as "Equipment Out of Adjustment".

Note: The Physiotherapist may be called to make adjustments during the 90-second changeover; however, any delays shall be penalized in accordance with the Point Penalty Schedule. If the player makes the adjustment without the help of the Physiotherapist and violates the continuous play rule, then the player shall be penalized in accordance with the penalties set forth under "Unreasonable Delay", i.e., Time Violation.

Treatment for Fatigue

Case: May a Physiotherapist put his hands on a player suffering from what appears to be fatigue?

Decision: Yes. The Physiotherapist then makes the decision regarding a medical time-out.

Treatment: Within 90 Seconds

Case: After an even game, a player asks to see the Physiotherapist on the next changeover. The next game ends and 90 seconds elapse without the Physiotherapist arriving on-court. The player asks that the changeover time be extended so that he may receive treatment. His rationale is that the Physiotherapist's arrival to the court is not the player's fault.

Decision: The Chair Umpire suspends play until the Physiotherapist examines the player and determines whether a medical Time-out is needed.

When to Take a Medical Time-Out?

Case: What happens if a player is injured during a match and decides not to take his injury time-out right away? (Before the end of the next change-over)

Decision: A player may call for the Physiotherapist at any time. The Physiotherapist shall determine whether the medical time-out is to be authorized.

Chair Umpire Orders Medical Time-Out

Case: A player has an accidental ankle injury and the Chair Umpire believes that continued play will result in non-professional play. May the Chair Umpire stop play (and call for the Physiotherapist)?

Decision: Yes.

VII. THE COMPETITION

Singles Retirement: Still in Doubles?

Case: A player retires from his singles match because of illness or medical reason. May he compete in the doubles competition?

Decision: If upon examination by the tournament Doctor after the retirement and again before the player's scheduled doubles match, it is determined that the player's condition has "improved" to the extent that he can compete at a professional level, then the player may continue in the doubles competition. If the player's condition has not improved then he must not be allowed to compete in the doubles.

S. Miscellaneous Officiating Cases and Decisions

Broken String: First Service Fault

Case: On a first service fault, the receiver breaks a string.

Decision: In Singles matches If the receiver changes his racquet, then a first serve will be awarded to the server. If the receiver elects not to change racquets, then the server must play a second serve.

In Doubles matches if the receiver changed the racquet with his partner the Chair Umpire should award a second serve unless in his opinion the replacement time was such that the server was delayed in his delivery of a serve.

Broken String: First Service Let

Case: The receiver breaks a string on a first service let.

Decision: The receiver must change racquets. A player is allowed to finish the point with a broken string but may not start a point with a broken string.

Broken String: No Racquets

Case: The player breaks a string in his last racquet.

Decision: The player is not allowed to continue with broken strings. The player is subjected to the penalties set forth in the Point Penalty System for Unreasonable Delay.

Receiver Not Ready

Case: The receiver is not ready but looks up as the second serve is hit, reflexes a return and says, "wait."

Decision: Second serve. The server should observe that the receiver is ready. (If the Chair Umpire believes that gamesmanship is involved on the part of the receivers, then he may issue a code violation for Unsportsmanlike Conduct).

Ball Hits Net Post Signage

Case: The ball, while in play, hits the top of the ATP net signage and goes into the proper court.

Decision: ATP net signage will be considered permanent fixtures (other than the net, posts, singles sticks, cord or metal cable, strap or band) and will result in the loss of point.

Ball hits Overhead Camera Cable

Case: A player throws up a lob which is over the court and it hits the cable supporting Spider Cam which is positioned diagonally across the court from the service line to baseline. Is the point awarded to the opponent; is the point replayed; or does play continue?

VII. THE COMPETITION

Decision: The cable is considered a permanent fixture and therefore, it is a loss of point.

Invasion: Ball in Play

Case: A player's dampening device flies out of his racquet and touches the net or goes into his opponent's court.

Decision: If the ball was still in play, the player loses point. The dampening device shall be considered a part of the racquet.

Invasion: No Replay

Case: After the point has been completed, player discovers opponent's dampening device lying in his court. The player claims a point based on Rules of Tennis, rule "Rule 24").

Decision: The point stands as played. Since the Chair Umpire did not see the dampening device land in the opponent's court, he may not rule that an invasion occurred. Invasion occurs only when the ball is in play. Since the Chair Umpire did not know the timing of the incident, he may not assume that an invasion did occur.

Player Hits Net Pipe Support

Case: A player touches a "pipe support" with his foot while the ball is in play.

Decision: In this case the "pipe support" is to be considered as part of the net; thus if a player touches it while the ball is in play, he loses the point.

Touching Net or Opponent's Court

Case: If while the ball is in play a player's foot slides under the net but does not touch the net, should this still be considered a "touch" since the net should have extended fully to the court surface?

Decision: No. This cannot be considered a "touch" if the player did not actually touch the net. It is likely, however, that an invasion has occurred from the player's foot touching his opponent's court. If this did occur, then the Chair Umpire shall call an "invasion" and award the point to the player's opponent.

Ball Touches Net Pipe Support

Case: The ball falls over the net and hits the "pipe support" used on indoor courts.

Decision: In this case, the "pipe support" is to be considered as part of the court; thus when the ball hit the pipe, it would be ruled as a first bounce.

Player Touches Net Outside of Singles Stick

Case: A player runs for a drop shot and returns it into the opponent's court and then runs into net between net post and singles stick. What is the ruling?

Decision: Play continues. This part of the net is considered a permanent fixture.

Ball Rolls Onto Court

Case: After a first service fault, a ball comes into the court from another court.

Decision: If the server has started his motion, then a first serve shall be awarded. In other cases, a second serve shall be played

VII. THE COMPETITION

unless in the opinion of the Chair Umpire the delay was unusually long and unfairly disrupted the rhythm of the server.

Umpire Unsighted

Case: A Line Umpire is unsighted and the Chair Umpire cannot make the decision.

Decision: The point is replayed, except in the case where it was discovered after the point had been completed that during a rally a Line Umpire had been unsighted. In that case, the point would stand as played.

Intimidating Line Umpire

Case: A serve is hit near the sideline and the receiver, hearing no call, immediately turns around and screams at the Line Umpire. The Line Umpire, who had signaled good, then calls and signals out.

Decision: The Chair Umpire rules the serve good based on the Line Umpire's original call. The Supervisor, if called, upholds the Chair Umpire's decision based on an official not changing his call based on a player appeal.

Note: The Chair Umpire may have to ask for the Line Umpire's original call if he is uncertain or disregard the Line Umpire's call and make the call himself.

Service Order

Case: In a doubles match, Team A serves out of order. After two points have been played, the Chair Umpire realizes the mistake.

Decision: The Chair Umpire should correct the mistake immediately.

Receiving Order

Case: In a doubles match, the players on the team switched their receiving positions during the set. When this is realized, what action should the Chair Umpire take?

Decision: The original receiving positions of each player on that team must be taken after the completion of the game in progress. If error occurred during a tie break, then the receiving order shall remain as altered until the completion of the tie break game.

7.23 Line Umpire Requirement, Positions and Calls

A. Number for Matches

- 1) **Full Complement of Line Umpires.** If a Chair Umpire has a full complement of Line Umpires, then the assignments shall be as follows:
 - a) Base, side, center service and service Line Umpires call all "Outs" and "Faults" for their respective lines.
 - b) Net judge calls all "Nets" and "Throughs" (if designated by the Chair Umpire), measures the net height at the beginning of each set and administers the ball changes. A net device may be authorized for use.
 - c) Base, side and center service Line Umpires call "Foot Faults" on their respective lines.
 - d) Chair umpire calls all "Lets," "Foul Shots," "Foul Strokes," "Hindrances," "Not Ups" and "Touches."
 - e) Line umpires shall not be permitted to call through the net.

VII. THE COMPETITION

- 2) **Less than a Full Complement of Line Umpires.** If less than a full complement of Line Umpires is available, the following should be used (Sufficient Line Umpires must be assigned in the main draw so that the Chair Umpire is not solely responsible for calling any one line.):
 - a) **Seven (7) Line Umpires.** All long lines are called only up to the net. Serves are called from the receiver's end and the center Line Umpire returns to his assigned sideline after the serve is put into play, i.e., there is movement during the point. The assignments for seven (7) Line Umpire crew are as follows:
 - i) Four (4) side Line Umpires, one of who calls the receiver's center service line; after the serve is put into play, this umpire returns to his assigned side line. (The umpire calling the center service line on the receiver's end moves during the point when he returns to his assigned side line after the serve is put into play.) In addition, the side Line Umpire on the receiver's end shall alternate calling the center service line of the "deuce" and "advantage" courts, moving between points.
 - ii) One Line Umpire calls serves at each end of the court.
 - iii) One Line Umpire calls each base line (2).
 - iv) Chair umpire calls all "Lets," "Not Ups," "Foul Shots," "Touches," "Hindrances" and "Throughs."
 - b) **Six (6) Line Umpires.**
 - i) Three (3) umpires cover the long lines; the side service lines are called through the net from the server's end of court and the center service line is called from the receiver's end.
 - aa) There is no movement during a point.
 - ii) One Line Umpire calls serves at each end of the court.
 - iii) One Line Umpire calls each base line (2).
 - iv) Chair umpire calls all "Lets," "Not Ups," "Foul Shots," "Touches," "Hindrances" and "Throughs."
 - c) **Five (5) Line Umpires.** The assignments are the same as for the six (6) man crew, except that the center service Line Umpire shall move after the serve to the side line.
 - d) **Four (4) Line Umpires.** The assignments are the same as for the five (5) man crew, except that the Chair Umpire, depending on personal preference and court surface, selects the lines that he will call.
 - e) **Less Than Four (4) Line Umpires.** The Chair Umpire shall assign the Line Umpires to the best advantage possible.
 - f) **Umpiring Without Line Umpires.** If a Chair Umpire is required to umpire a match without any Line Umpires, or without a full complement of Line Umpires, then the Chair Umpire must make the calls for the net and all unattended lines. If the Chair Umpire is unable to give a decision on a call or other questions of fact, then he must order a "Let" to be played.

Players Don't Call Lines

Case: In ATP Tour or ATP Challenger Tour qualifying events where approval has been granted to use less than five (5) Line Umpires per match; may the Chair Umpire designate certain or all lines for the players to make the calls?

Decision: No. If a Chair Umpire is required to umpire a match without any Line Umpires or without a full complement of Line Umpires, then the Chair Umpire must make the calls for the net and all unattended lines.

VII. THE COMPETITION

B. Hand Signals of Line Umpires

The approved hand signals are as follows:

- 1) **“Out” or “Fault.”** The arm should be fully extended sideways at shoulder height, pointing in the direction in which the ball has fallen, palm of the hand facing the Chair Umpire, fingers extended and joined. If the ball falls out of the court to the left or the right, the left or right arm as the case may be is extended after the verbal call of “Out” or “Fault” (as applicable) is made. The hand signal is in addition to and is secondary to the verbal call of “Out” or “Fault”; the hand signal must never be used instead of the verbal call.
- 2) **“Good Ball.”** The hands shall be pointed down with palms down and fingers extended together. There is no verbal call for a good ball. The hand signal is used in silence and only when necessary to verify that a close ball was good.
- 3) **“Un sighted.”** The hands are placed beneath the eyes facing in the direction of the Chair Umpire but not affecting the vision of the Line Umpire. The hand signal verifies that a Line Umpire is unable to call a ball because of his vision being obscured. There is no verbal call for a Line Umpire being unsighted and the hand signal is used in silence.

7.24 Scoring of Match

A. Manual

The Chair Umpire shall mark his scorecard in accordance with the following:

- 1) **Pre-Match.** Before the pre-match meeting with the players, ensure the completion of the information requested on the scorecard such as name of tournament, round, players' names, etc.
- 2) **Toss.** After the “toss,” note who won the toss, their election, etc.
- 3) **Warm-Up.** Note the time that the warm-up begins.
- 4) **Time.** Note the time play begins and concludes in each set.
- 5) **Sides For Serve.** Note the initials of each player in the order of their serves and also on the side of the scorecard corresponding to their proper sides of the court.
- 6) **Ball Change.** Mark in advance the game for which a ball change will be made on the left side of the scorecard.
- 7) **Points.** Points should be made by slanted marks in the boxes on the scorecard and/or by the following code:
 - “A” - Ace
 - “D” - Double Fault
 - “C” - Code Violation
 - “T” - Time Violation
 - “.” - First Service Fault (a dot shall be made in the middle of the bottom line of the Server's box).
- 8) **Games.** Games may be marked by either of the following methods:
 - a) **Method A.** The cumulative total of games won by each player is set out in the “Games” column at the end of each game; and

VII. THE COMPETITION

- b) **Method B.** The cumulative total of games won by the winner of each game only is set out in the “Games” column at the end of each game.

B. Handheld Device

Instructions will be provided on-site at ATP Tour tournaments for the operation of the handheld scoring device.

C. Point Penalty Card

The Chair Umpire must mark his Point Penalty Card in accordance with the following:

- 1) **Post-Match.** If a Code Violation, Time Violation or Post Match incident occurs, complete the information requested on the Point Penalty Card, such as name of tournament and a summary of the incident.
- 2) **Rules Violation.** The violation should be checked and the Code section noted for each violation.
- 3) **Statement of Facts.** A contemporaneous statement should be made of all the facts (who, what, when, where and why) of the violation quoting verbatim any statements made that are considered to be obscene or abusive.

7.25 Announcing

A. Calls of On-Court Officials

The verbal calls of the on-court officials shall be made loudly and clearly in English and any other appropriate language as follows:

- 1) **“Fault.”** If either the first or second service fails.
- 2) **“Out.”** If a return hits the ground, a permanent fixture or another object outside the court.
- 3) **“Net”** If a service hits the top of the net.
- 4) **“Footfault”** If a player violates rule 7 or 8 of the Rules of Tennis.
- 5) **“Let.”** If the Chair Umpire determines that a point should be replayed.
- 6) **“Not Up.”** If a player fails to hit a ball in play on the first bounce.
- 7) **“Foul Shot” or “Touch.”** If a ball is intentionally struck twice, or touched before it comes over the net, or while volleying, the ball hits the court after leaving the racquet before going over the net, or a player touches the net while the ball is in play, or a ball in play touches a player, or anything that he wears or carries falls into the opponent's court or touches the net.
- 8) **“Hindrance.”** If a player deliberately or involuntarily commits an act which hinders his opponent in making a stroke.
- 9) **“Through.”** If a ball goes through the net.
- 10) **“Wait Please.”** To preclude starting play when a hazard or other circumstance makes it appropriate to delay the beginning of a point. Do not make this call if a player's arm is in motion to strike the ball (call “Let” immediately after the serve is struck).

VII. THE COMPETITION

11) **Override.** Make the following announcement:

- a) **“Correction,** the ball was in;” or
- b) **“Out” or “Fault.”**

B. Code and Time Violations

The following are examples of Code of Conduct announcements to be used:

1) Point Penalties assessed for violation of the Code should be announced in accordance with the following examples:

“Code Violation, Delay of Game, Warning, Mr.____(last name).”

“Code Violation, Verbal Abuse, Point Penalty, Mr.____(last name).” “Let’s play” (“Let’s Play” is optional).

“Code Violation, Verbal Abuse, Game Penalty, Mr.____(last name).”

If instructed by the Supervisor, the announcement for a default shall be, for example:

“Code Violation, Unsportsmanlike Conduct, Default, Mr.____(last name).”

2) Time Violations resulting from non-compliance with the Unreasonable Delay provisions of the Code shall be announced in accordance with the following examples:

“Time Violation, Warning, Mr.____(last name).” (“Let’s Play” is optional.)

Subsequent Delays by the Server:

“Time Violation, 2nd Service” (“Let’s Play” is optional.)

Subsequent Delays by the Receiver:

“Time Violation, Point Penalty, Mr.____(last name).” (“Let’s Play” is optional.)

3) After a point or game penalty, the new score is announced.

4) If a Chair Umpire wants the Supervisor to assess an immediate default, he is to announce “Code Violation, Supervisor to the court.”

5) A player cannot appeal to the Chair Umpire for the withdrawal of a “Time Violation” or “Code Violation” given to his opponent.

6) Code Violations shall be announced in English.

C. Language - Chair Umpire

Chair umpires should announce matches in the language of the tournament and subsequently in English. Conversations between the Chair Umpire and player may be in any language; however, if the language used is not English, then the Chair Umpire must be prepared to advise the other player of the nature of the discussion.

D. Medical Time-Out

The following are examples of announcements to be made when there is a medical time-out:

When the Chair Umpire decides to call for the Physiotherapist, the Chair Umpire shall announce:

“The Physiotherapist has been called to the court.”

After a three (3) minute time-out is authorized, the Chair Umpire should make the public announcement of:

VII. THE COMPETITION

“Mr. _____ is now receiving a medical time-out.”

The following announcements are to be made privately to the Physiotherapist and both players/teams:

“Two (2) minutes remaining”

“One (1) minute remaining”

“Thirty (30) seconds remaining”

“Treatment complete”

“Time” (public)

Once the “Treatment complete” notice has been given to the Physiotherapist and both players/teams, then if needed, the player should be given the time necessary to put on socks and shoes before “Time” is called.

If there is no play after an additional thirty (30) seconds, the delay is penalized in accordance with the Point Penalty Schedule.

E. Player Introductions

The following are examples of announcing statements to be used for player introductions:

- 1) If the introduction of players is to be made from the chair, then during the warm-up, the Chair Umpire says: “This is a ____round singles/doubles match, best of three (3) tie-break sets. To the right of the chair ____ (full name) and to the left of the chair ____ (full name). ____ (full name) won the toss and elected to ____.”
- 2) If the introduction of players is made by a tournament announcer, then before each player’s first service game the Chair Umpire says: “____ (full name) to serve.” (optional - “first set”).

F. Score

The following are examples of announcing statements to be used for scoring:

- 1) The Server’s score is always called first, except in the Tie-break.
- 2) The score is announced: Fifteen-Love, Love-Fifteen, Thirty-Love, Love-Thirty, Forty-Love, Love-Forty, Fifteen-All, Fifteen-Thirty, Thirty-Fifteen, Fifteen-Forty, Forty-Fifteen, Thirty-All, Thirty-Forty, Forty-Thirty, Deuce (never Forty-All), Advantage ____ (last name), Game ____ (last name). For No-Ad scoring, when the score reaches deuce, the chair should announce: “Deuce, Deciding Point, Receiver’s Choice.”
- 3) The score must be announced loudly and distinctly when a point is finished for the players and the crowd. The Chair Umpire has the option to make the announcement either before or after the applause, whichever guarantees the announcement can be heard by the players. “Timing” for the next point begins when the point ends, not when the announcement is made.
- 4) At the end of a game or set the Chair Umpire, in addition to announcing “Game ____ (last name),” should announce the score in games in conformity with the following example:

VII. THE COMPETITION

“Game Smith, Jones/Smith lead 4 games to 2 (or 4-2)” or Game Smith, 3 games all.”

“Game and third set, Smith, 7 games to 5. Jones leads 2 sets to 1.”

If there is a scoreboard visible to the spectators, then the set number need not be mentioned. In such case only the score in games should be announced: “Game Smith, first game.”

- 5) When a set reaches the Tie-break, the Chair Umpire announces:

“Game Smith, 6 games all. Tie-break.”

- 6) During the Tie-break, the score is announced by first giving the score and then the name of the player(s) leading, e.g.:

“1-0, Jones” or “1-0, Jones/Smith” (Use “Zero” rather than “Love” in the Tie-break.)

“1 All”

“2-1,Smith”

At the conclusion of the Tie-break, the Chair Umpire announces:

“Game and ____ set, ____ (last name), 7 games to 6 (or 7-6).”

- 7) At the conclusion of the match, the Chair Umpire announces the winner in conformity with the following example:

“Game, set and match Smith (optional -3 sets to 2); 3-6, 5-7, 7-5, 6-1, 6-3.”

In each set, call first the number of games won by the winner of the match.

- 8) During the warm-up, the following examples of announcing statements should be used at the appropriate times:

“Three (3) minutes - 3 minutes until warm-up ends.

“Two (2) minutes” - 2 minutes until warm-up ends.

“One (1) minute” - 1 minute until warm-up ends.

“Time” (optional - “prepare to play”)- end of warm-up; direct balls to Server’s end of court.

“_____” (full name), (optional - “first set”), to Serve, Play” - immediately prior to Server preparing to serve.

VIII. THE CODE

8.01 Tournament Obligations

A. Application Requirements

Each tournament agrees to comply with all provisions contained in the ATP Tour tournament and ATP Challenger Tour Applications where applicable.

B. Ranking Based Entry

Each tournament agrees to accept entries of tennis players on the basis of the Pepperstone ATP Rankings and the Pepperstone ATP Doubles Rankings.

Exception: ATP will accept tournaments in countries where Covid-19 vaccination is required for entry into the country.

C. Other Circuit

Each ATP Tour tournament and ATP Challenger Tour tournament agrees to refrain from being advertised or promoted as part of any other circuit or series of tournaments, unless expressly authorized by ATP.

8.02 Tournament Standards Violations

No ATP Tour or ATP Challenger Tour tournament shall violate any provision of ATP’s rules, regulations, or conditions of approval. Unless otherwise specified, a violation of this section shall subject the tournament to a fine specified in the table below (“Tournament Standards Violations Fines Table”).

Violation	Sanction*
Failure to meet basic Tournament Standards with no material impact on competition, players, or the overall image of the ATP Tour / ATP Challenger Tour / tournament	Warning or a fine up to \$25,000
Failure to meet Tournament Standards with minor impact on competition, players or the overall image of the ATP Tour / ATP Challenger Tour / tournament	Fine up to \$50,000
Failure to meet Tournament Standards with significant impact on competition, players or the overall image of the ATP Tour / ATP Challenger Tour / tournament	Fine up to \$100,000
Major, willful, and/or repetitive non-compliance with the Tournament Standards	Fine up to a maximum of \$250,000 and/or a change in category and/or membership status**

*Specific amounts are on a per violation basis and should depend and may vary on the severity of the violation and issue(s) presented. This maximum fine amount will increase by one-hundred percent (100%) for each consecutive year violation of the same standard by a tournament.

VIII. THE CODE

** Change in category and/or membership status is subject to a decision by the ATP Board.

A. On-Site

On-site violations may include, but are not limited to, tournament obligations specified in the current ATP Official Rulebook under sections titled ATP Circuit Regulations, Branding, Financial, Personnel and Facilities & On-Site Conditions.

B. Security at Tournaments

Each tournament has the responsibility to provide security at the tournament site. Tournaments must submit their security plan sixty (60) days in advance to the ATP Security Director.

C. Tournament Report

Each ATP Tour and ATP Challenger Tour tournament shall submit to ATP a report of the tournament and its affairs as requested by ATP.

D. ATP Fantasy Sport and Sponsorship

ATP Tour tournaments may enter sponsorship agreements with a company that offers wagering on tennis (a "Tennis Betting Operator") subject to the terms and conditions stated in Exhibit AD. The agreements may not extend beyond December 31, 2026. ATP Challenger 125 and 175 tournaments may enter sponsorship agreements with a Tennis Betting Operator subject to those agreements being sold and controlled centrally by the ATP, the revenues are distributed to the relevant tournaments and follow the rules applicable to ATP Tour events. The agreements for ATP Challenger 125 and 175 tournaments may not extend beyond December 31, 2026. ATP will assess any negative effects of such sponsorship agreements in determining whether to extend these periods.

ATP Tour tournaments may accept sponsorship from a fantasy sport branded company promoting only the fantasy sport brand. If the company does not offer, and is not affiliated with a company that offers, wagering on tennis, or if a betting, casino, lottery or fantasy sport-branded company is not a Tennis Betting Operator and the proposed sponsorship will not promote a Tennis Betting Operator, these rules shall not apply to the sponsorship and there are no restrictions on the sponsorship agreement, except that ATP approval shall still be required and Tournament Support Personnel shall still comply with the TACP (as defined below). If, during the term of the sponsorship, the company becomes a Tennis Betting Operator or the sponsorship will promote a tennis betting brand, the sponsorship must comply with these rules. However, most fantasy sport brands offer, or are affiliated with companies that offer, wagering on tennis and constitute a Tennis Betting Operator as defined herein. In that case, all the terms and conditions in Exhibit AD apply to such fantasy sport Tennis Betting Operator. Such agreements may not extend beyond December 31, 2026.

E. On-Site Tennis Betting

No ATP Tour or ATP Challenger Tour tournament shall, directly or indirectly, solicit or facilitate any person to wager on tennis matches while at the tournament site. Allow-

VIII. THE CODE

ing betting companies, directly or through a third party, to accept any tennis wagers (electronically or otherwise) at the tournament site or any tournament related event is prohibited.

F. Determination of Violation and Penalty

The SVP – Rules & Competition shall make a reasonable investigation to determine the facts regarding all tournament on-site offenses. Upon determining that a violation has occurred, the SVP – Rules & Competition shall specify the fine and/or other punishment in written notice to the tournament. The tournament shall have the right to appeal such determination to the ATP Standards Committee, consistent with the procedures outlined in the Code.

G. Payment of Fines

Fines levied by the SVP – Rules & Competition for tournament on-site offenses shall be paid in accordance with the following:

- 1) ATP Tour and ATP Challenger Tour Tournaments. Each tournament shall promptly pay the fine to ATP.
- 2) The tournament may authorize ATP to withhold the amount of the fine from any monies owed the tournament by ATP.
- 3) If the monies owed to the tournament are insufficient to pay the fine, the tournament shall pay the balance within twenty-one (21) days after receiving written notice of the fine.

H. Procedures for Appeal

- 1) Any tournament in violation of a tournament on-site offense may, after paying all fines, appeal to the ATP Standards Committee for review of a determination of guilt and the penalty assessed.
- 2) Such appeal shall be in accordance with the procedure specified in Section 8.03 F. 4.

8.03 Tournament Major Offenses

No ATP Tour or ATP Challenger Tour tournament shall violate any provision of ATP's rules and regulations contained below under the Tournament Major Offense section of the current ATP Official Rule Book. Unless otherwise specified, violation of this section shall subject the tournament to a fine up to \$250,000, or in the case of Tournament Standards Violation under the Tournament Standards Violations Fine Table, plus any additional financial penalties specified in other rules, and/or change in membership status, and/or forfeiture of all sums, if any, previously paid to ATP.

A. Conduct Contrary to the Integrity of the Game

The favorable reputation of ATP, its tournaments and players is a valuable asset and creates tangible benefits for all ATP members. Accordingly, it is an obligation for ATP Tour or ATP Challenger Tour tournaments, owner(s), promoter(s), operator(s) or representative(s) thereof, to refrain from engaging in conduct contrary to the integrity of the game of tennis. Conduct contrary to the integrity of the game shall include, but not be limited to, comments to the news media publicized comments that unreasonably

VIII. THE CODE

attack or disparage any person or group of people, a tournament, sponsor, player, official or ATP.

Responsible expressions of legitimate disagreement with ATP policies are not prohibited. However, public comments that one of the stated persons above knows, or should reasonably know, will harm the reputation or financial best interests of a tournament, player, sponsor, official or ATP are expressly covered by this section.

B. Aggravated Behavior

- 1) No ATP Tour or ATP Challenger Tour tournament, or any person who directly or indirectly has a controlling ownership interest therein or who is the Designated Representative (as defined in the ATP By-Laws) or Tournament Director or other employee or agent of an ATP Tour or ATP Challenger Tour tournament shall engage in aggravated behavior which is defined as follows:
 - a) One incident of behavior that is flagrant and particularly injurious to the success of the ATP or its members or is singularly egregious.
 - b) A series of two (2) or more violations of this Code in consecutive years which singularly do not constitute aggravated behavior, but when viewed together establish a pattern of conduct that is collectively egregious and is detrimental or injurious to ATP and/or its members.

C. Promotional Fees

- 1) ATP Tour 500 and ATP Tour 250 tournaments have the option to offer fees for promotional services. No other ATP Tour or ATP Challenger Tour tournament owner, operator, sponsor or agent is permitted to offer, give or pay money or anything of value, nor shall the tournament permit any other person or entity to offer, give or pay money or anything of value to a player, directly or indirectly, to influence or assure or entice a player's competing in a tournament or event within the tournament, other than prize money, unless authorized to do so by ATP.
- 2) In the event the ATP CEO or Senior Vice President - Rules & Competition believes that a tournament may be violating this section, then upon demand, the tournament must furnish to the Senior Vice President - Rules & Competition or his agent access to and copies of all records to which it has access relating to such alleged prohibited compensation or, in the absence of such records, an affidavit setting forth the facts in detail with respect to any transaction under question by the Senior Vice President - Rules & Competition. In the event a tournament fails to provide such records or affidavit for such audit, it may be subject to a fine up to \$100,000 and termination of membership, pending compliance with such demand.
- 3) Violation of this section shall subject the tournament to a fine up to \$100,000 plus the amount or value of any such compensation, and termination of membership, and/or forfeiture of all sums, if any, previously paid to ATP.

D. Wagers and On-Site Tennis Betting

No ATP Tour or ATP Challenger Tour tournament, ATP member or any person who directly or indirectly has a controlling ownership interest therein or who is the Designated Representative (as defined in the ATP By-Laws) or Tournament Director or other employee or agent of an ATP Tour or ATP Challenger Tour tournament or ATP member (excluding employees or agents who do not have executive or material man-

VIII. THE CODE

agement authority) shall engage in any form of gambling or wagering in connection with any ATP Tour or ATP Challenger Tour tournament.

E. Wild Cards

No ATP Tour or ATP Challenger Tour tournament, or any person who directly or indirectly has a controlling ownership interest therein or who is the Designated Representative (as defined in the ATP By-Laws) or Tournament Director or other employee or agent of an ATP Tour or ATP Challenger Tour tournament shall directly or indirectly, accept compensation in exchange for a wild card.

F. Investigation, Determination, Imposition and Review

- 1) The Senior Vice President - Rules & Competition shall investigate all facts concerning any alleged tournament violation of an ATP rule or regulation and shall provide written notice of such investigation to the tournament involved. The tournament shall be given at least five (5) days (excluding weekends) to provide to the Senior Vice President - Rules & Competition, directly or through counsel, such evidence as the tournament deems to be relevant to the investigation. The Senior Vice President - Rules & Competition shall conduct the investigation in consultation with the applicable ATP Regional EVP or SVP.
- 2) Upon the completion of his investigation, the Senior Vice President - Rules & Competition shall determine the innocence or guilt of the tournament involved and, in the latter case, shall state in writing the facts as found by him, his conclusions and the penalty to be imposed on the tournament. A copy of the decision of the Senior Vice President - Rules & Competition shall be promptly delivered to the tournament with copies to the ATP CEO, or in the case of Standards Violations, the ATP Standards Committee and the applicable ATP Regional EVP or SVP.
- 3) All fines shall be paid by the tournament by delivery to the Senior Vice President - Rules & Competition within twenty-one (21) days after receipt of written notice.
- 4) Any tournament found to have violated an ATP rule, regulation or condition of approval that results in a fine, may, after paying all fines, petition the ATP CEO for discretionary review, or in the case of Standards Violations, the ATP Standards Committee. This petition shall be in writing and must be filed with the ATP CEO, Senior Vice President - Rules & Competition, or the ATP Standards Committee (as applicable) within twenty-one (21) days after notice of the determination and penalty is received by the tournament. (The Senior Vice President - Rules & Competition shall forward the review petition promptly to the ATP CEO or ATP Standards Committee (as applicable)). Such petition shall state in detail the basis for the appeal. Within twenty-one (21) days after receipt of the petition, the ATP CEO or his designee, or in the case of Standards Violations, the ATP Standards Committee shall determine whether the appeal should proceed to a hearing or if a determination based upon the facts as presented is appropriate. If the ATP CEO or his designee, or in the case of Standards Violations, the ATP Standards Committee determines that the appeal should not proceed to a hearing, then the decision, upon notice to the tournament, becomes final. This decision may affirm, reverse or modify the decision of the Senior Vice President - Rules and Competition. If the ATP CEO or his designee, or in the case of Standards Violations, the ATP Standards Committee determines that the appeal should proceed to a hearing, he shall designate a date, time and place for the hearing of the appeal, and the ATP CEO or his designee, or in the case of Standards Violations, the ATP

VIII. THE CODE

Standards Committee shall notify the tournament and the Senior Vice President - Rules & Competition. At the hearing, the tournament and the Senior Vice President - Rules & Competition shall present to the ATP CEO or his designee, or in the case of Standards Violations, the ATP Standards Committee, their respective positions on the facts. On the appeal, the ATP CEO or his designee, or in the case of Standards Violations, the ATP Standards Committee may affirm, reverse or modify the decision of the Senior Vice President - Rules & Competition. If the appeal is decided against the tournament, then the ATP CEO or his designee, or in the case of Standards Violations, the ATP Standards Committee shall charge to the tournament the reasonable costs of the appeal, which shall include, but not be limited to, the reasonable travel and living expenses incurred by all witnesses..

- 5) If the penalty imposed on the tournament includes a recommendation for loss or change in tournament membership status, that recommendation shall be reviewed by the ATP Board, which may implement, modify or reject the recommendation of the Senior Vice President - Rules & Competition or ATP Standards Committee. The imposition of any non-fine penalty by the ATP Board shall be made in accordance with the By-laws.
- 6) Service of any document on a tournament as is required by this section shall be deemed completed if mailed to the Tournament Director at the address indicated in the tournament application or as subsequently revised by the tournament member. Any written communication to be sent to the ATP CEO or Senior Vice President - Rules & Competition, or in the case of Standards Violations, the ATP Standards Committee should be addressed as follows, unless notice of change is subsequently published.

ATP CEO	OR	SVP - Rules & Competition or ATP Standards Committee
22 Worple Road		ATP
Wimbledon		201 ATP Tour Blvd.
SW14 4DD		Ponte Vedra Beach, FL 32082, USA
Telephone: +44 207 381 7890		Telephone: +1 904 285 8000
Facsimile: +44 207 381 7895		Facsimile: +1 904 779 3300

- 7) ATP is authorized to obtain collection of all overdue fines along with costs, if any, by all reasonable means, including legal proceedings as may be deemed necessary and appropriate.

8.04 Player Code of Conduct (“Code”)

A. Entry/Withdrawal Offenses

Entry Obligations. No player or team entered into the main draw or moved into the main draw as a direct acceptance of a tournament may withdraw after the entry and withdrawal deadline or not appear for first-round match(es) without penalty as described below. The Senior Vice President, Rules & Competition shall make such investigation as is reasonable to determine the facts regarding any such entry offense and, upon determining that a violation has occurred, shall specify the fine.

VIII. THE CODE

B. Fines

1) ATP Tour Tournaments

- a) The provisions relating to assessment and payment of withdrawal, late withdrawal or punctuality fines for tournaments are separate from but in addition to the provisions of the player ATP commitment. The penalties are:

i) Singles

- aa) **ATP Tour 250 Only.** Withdrawals occurring prior to the 10 AM, Eastern time, USA, Friday withdrawal deadline:

ATP Pepperstone Rankings (most recent)	Third (3rd) Offense	Fourth (4th) Offense	Fifth (5th) and Subsequent Offenses
1 - 10	\$10,000	\$20,000	\$40,000
11 - 25	\$5,000	\$10,000	\$20,000
26 - 50	\$2,000	\$4,000	\$8,000
51-100	\$1,000	\$2,000	\$4,000
101 +	\$500	\$1,000	\$2,000

- bb) **ATP Tour Masters 1000, ATP Tour 500 & 250 events.**

Withdrawals occurring after the 10 AM, Eastern Time, USA, Friday withdrawal deadline (Late Withdrawals):

ATP Pepperstone Rankings (most recent)	First (1st) Offense	Second (2nd) Offense	Third (3rd)* and Subsequent Offenses
1 - 10	\$20,000	\$40,000	\$80,000
11 - 25	\$10,000	\$20,000	\$40,000
26 - 50	\$4,000	\$8,000	\$16,000
51-100	\$2,000	\$4,000	\$8,000
101 +	\$1,000	\$2,000	\$4,000

*For purposes of determining 2nd, 3rd and Subsequent Offenses, only Late Withdrawals are counted.

ii) Doubles.

- aa) If the withdrawal was after 10 AM, Eastern time, USA, Friday and prior to the onsite sign-in deadline then the fine is \$1,000 per team member (doubled if team would have been seeded).

- bb) If the withdrawal was after the on-site sign-in deadline then this is to be considered as a Late Withdrawal and the fine is \$2,500 per team member (doubled if team would have been, or was, seeded).

- iii) **Doubles Qualifying.** If the withdrawal was after 10 AM Eastern time, USA, Friday, then the fine is \$500 per team member (doubled if the team would have been seeded).

VIII. THE CODE

iv) Doubles – Exceptions

aa) If both members of the team were on-site at the time of the withdrawal and the withdrawal was due to a medical condition, then neither player is subject to a fine.

bb) If the withdrawal was due to one or both members of the team being accepted into the main draw singles of another event, then neither player is subject to a fine.

b) Fines shall be doubled in the case of any player who would have been seeded, based on the most recent Pepperstone ATP Rankings.

c) **ATP Tour Masters 1000 or ATP Tour 500 Qualifying.** Third and subsequent withdrawals from the qualifying competition will be fined \$250 or \$500 if he would have been seeded based upon the most recent Pepperstone ATP Rankings.

ATP Tour 250 Qualifying. Third and subsequent withdrawals from the qualifying competition will be fined \$250 or \$500 if he would have been seeded based upon the most recent Pepperstone ATP Rankings.

All ATP Tour Qualifying events. If the player withdraws after the 10 AM Eastern time, USA, Friday deadline, or is a No Show, it is a Late Withdrawal and the fine shall be \$1,000 (or \$2,000 if seeded).

d) In circumstances that are flagrant and particularly injurious to the success of a tournament, or are singularly egregious, a single violation of this section shall also constitute the player Major Offense of Aggravated Behavior.

2) ATP Challenger Tour Tournaments

a) The penalty for fourth and subsequent withdrawals is a fine of \$250 for each offense and applies to singles. Fines shall be doubled in the case of any player who would have been seeded, based on the most recent Pepperstone ATP Rankings.

b) Any singles withdrawal occurring after 10 AM, Eastern Time, USA on Friday, shall be assessed a fine of \$1,000 (or \$2,000 if seeded).

c) **ATP Challenger Tour Qualifying.** Fifth and subsequent withdrawals from the qualifying competition will be fined \$150 or \$300 if he would have been seeded based upon the most recent Pepperstone ATP Rankings. If the player withdraws after the 10 AM Eastern time, USA, Friday deadline, or is a No Show, it is a Late Withdrawal and the fine shall be \$500 (or \$750 if seeded).

d) ATP Challenger Doubles.

i) If the withdrawal was after 10 AM, Eastern time, USA, Friday and prior to the onsite sign-in deadline then the fine is \$500 per team member (doubled if team would have been seeded).

ii) If the withdrawal was after the on-site sign-in deadline then this is to be considered as a Late Withdrawal and the fine is \$1,000 per team member (doubled if team would have been, or was, seeded).

iii) Doubles Exceptions apply as noted above for ATP Tour.

C. Tournament Rebates

Tournaments shall receive a rebate from ATP when the following conditions have occurred:

1) **ATP Tour Masters 1000.** All fine amounts collected as a result of late withdrawals shall be returned to the tournament where the late withdrawal occurred.

VIII. THE CODE

2) **ATP Tour 500.** All fine amounts collected as a result of late withdrawals shall be returned to the tournament where the late withdrawal occurred.

3) **ATP Tour 250.** All fine amounts collected as a result of withdrawals or late withdrawals shall be returned to the tournament where the withdrawal or late withdrawal occurred.

4) **ATP Tour Qualifying.** All fine amounts collected as a result of withdrawals or late withdrawals shall be returned to the tournament where the withdrawal or late withdrawal occurred.

D. Withdrawal Penalties

1) **ATP Tour 500.** Any player withdrawing after the entry/withdrawal deadline shall have a ranking penalty assessed in accordance with procedures specified in the ranking section of this rule book. Players shall not have the ranking penalty assessed if they complete the requirements for “promotional activities”; are out of competition for 30 days; or the withdrawal complied with the requirements for an on-site withdrawal. Players may appeal withdrawal penalties to a Tribunal who will determine whether the penalties are affirmed or set aside.

2) **ATP Tour Masters 1000.** Any player withdrawing from the main draw shall have a ranking penalty assessed in accordance with procedures specified in the ranking section of this rule book and be suspended from a subsequent ATP Tour Masters 1000 event. This event shall be the event where the player earned the highest point total during the previous 12 months. Subsequent withdrawals will carry a second suspension from the next event where the player earned his second highest point total. Additional withdrawals will include further suspensions in the same manner. Players shall not have the suspension penalty assessed if they complete the requirements for “promotional activities” or the withdrawal complied with the requirements for an on-site withdrawal. Players may appeal suspension penalties to a Tribunal who will determine whether the penalties are affirmed or set aside (see sections J & K). Ranking penalties are automatic and cannot be appealed.

NOTE¹: If there were no 1000 results, the suspension would be from the next Masters 1000 event he is accepted as a Direct Acceptance.

NOTE²: Players with grandfathered earned complete commitment reduction from all ATP Tour Masters 1000 events, who withdrew from that event for any reason the previous year, do not need to submit an appeal to avoid the suspension penalty.

E. Retirement or Withdrawal Penalty (On-Site)

1) A player who, because of injury or illness, retires during a match or withdraws during the tournament week must submit to an on-site medical examination by the designated tournament Doctor. Any player who retires during a match must be examined by the tournament Doctor prior to the end of play on the day of the retirement. Failure to submit to such examination shall be a violation of this section and shall subject a player to a fine at ATP Tour tournaments of \$10,000 (\$2,500 for the qualifying competition) or at ATP Challenger Tour tournaments to a fine of \$1,000, (\$500 for the qualifying competition), or the amount of prize money won at the tournament, whichever is greater.

VIII. THE CODE

- 2) Following any on-site retirement or withdrawal, the Supervisor at the next tournament in which the player wants to play, may require the player to submit to an on-site examination by the designated tournament Doctor and receive authorization from the Supervisor before competing in any future ATP Tour and ATP Challenger Tour tournaments. The Supervisor's authorization shall be based on the following: the results of the on-site medical examination; a review of such results with one of ATP's medical services directors, if possible; and any other appropriate information.

No Medical? Big Mistake

Case: *A player retires from his singles match and leaves the tournament site without having been examined by the tournament Doctor.*

Later, it is discovered that the player has left the tournament city. What action does the Supervisor take?

Decision: *Any player who fails to submit to an on-site examination by the tournament Doctor after retiring from a match shall be subjected to a fine of \$10,000 (\$1,000 for ATP Challenger Tour tournaments) or the amount of prize money won at the tournament, whichever is greater.*

F. Special Exempt/Wild Card Non-Appearance

A player who accepts a wild card or a special exempt pursuant to the procedures set forth under section 7.10, special exempts, shall appear for play. A violation of this section would be considered as a late withdrawal and be subject to the penalties set forth under late withdrawals.

G. Payment of Fines

The player shall pay all fines to ATP within ten (10) days after the notice of fine is provided to the player. All collected entry/withdrawal fine amounts, with the exception of Challenger fines, shall be returned to the event from which the fine was incurred.

H. Playing Another event

- 1) No player who has entered and been accepted into the main draw or qualifying of an ATP Tour or ATP Challenger Tour tournament shall play in any other tennis event during the period of such tournament, except if appropriately released by ATP. Once a player enters and is accepted into the main draw or qualifying of the singles or doubles competition, he is committed to that tournament for the week, unless released by the Senior Vice President - Rules & Competition or Supervisor. A violation of this section shall constitute the Major Offense of Aggravated Behavior.
- 2) A player who has entered and been accepted into the main draw of an ATP Tour or ATP Challenger Tour tournament shall be permitted to sign-in and compete in the doubles event of the same tournament if his withdrawal was for medical reasons and he is determined by the Supervisor, upon written medical advice, to be physically capable to compete on a professional level of play.
- 3) A player may receive permission from a Tournament Director of an ATP Tour 250 tournament to compete in a special event on the Monday of that tournament.

VIII. THE CODE

I. Repeal of Withdrawal Fines and/or Penalties

1) ATP Tour 250

a) Consecutive Withdrawals

- i) Players with multiple consecutive withdrawals* who are out of competition for thirty (30) days or more due to injury will not be subject to a fine as long as verified and approved medical forms are provided.

Note: The count shall begin on the withdrawal deadline date; the date of the retirement; the date of the late withdrawal; or the date of the on-site withdrawal, whichever was chronologically first.

- ii) A player must not compete in any other tennis event during those periods.

*Each consecutive withdrawal must be prior to 10 AM on Friday, before the tournament.

b) On-Site Medical Examination.

Players who withdraw after 10 AM Eastern Time, USA on Friday (or in the case of doubles, after the entry deadline) before a tournament shall not have the late withdrawal fine assessed if determined to be unfit to play that week if:

- i) The player who is still competing in a tournament or Davis Cup* after the Friday 10 AM deadline is forced to withdraw/retire and is examined by that event's Doctor and determined to be unfit for the following week's tournament; or
- ii) The player was on-site at the event when the withdrawal occurred and is determined to be unfit for play by that tournament's Doctor. Players who are examined by the on-site tournament Doctor shall receive tournament provided hotel rooms through the night of the examination.

* A withdrawal from Davis Cup must be from a "live" match, for medical reasons.

c) Promotional Activities.

A player who was not on-site when the withdrawal/late withdrawal occurred but travels to the tournament within the first three (3) days of the main draw, unless otherwise determined by ATP, and participates in a reasonable amount of promotional activities over a two (2) day period, as determined by ATP, shall not have the applicable fines assessed. Players who travel to the event to complete their promotional activity requirement shall receive full hospitality from the day of arrival through the night following the completion of their promotional obligation.

d) Appeal.

The player may appeal the fine to the SVP - Rules and Competition as specified below under "Review of Penalties for Entry and Commitment Offenses".

2) ATP Tour 500

a) Consecutive Withdrawals

- i) Players with multiple consecutive withdrawals* who are out of competition for thirty (30) days or more due to injury will not be subject to a late withdrawal fine or a ranking penalty as long as verified and approved medical forms are provided.

Note: The count shall begin on the withdrawal deadline date; the date of the retirement; the date of the late withdrawal; or the date of the on-site withdrawal, whichever was chronologically first.

- ii) A player must not compete in any other tennis event during those periods.

*Each consecutive withdrawal must be prior to 10 AM on Friday, before the tournament.

VIII. THE CODE

b) On-Site Medical Examination.

Players who withdraw after 10 AM Eastern Time, USA on Friday (or in the case of doubles, after the on-site entry deadline) before a tournament shall not have the late withdrawal fine or ranking penalty assessed if determined to be unfit to play that week if:

- i) The player who is still competing in a tournament or Davis Cup* after the Friday 10 AM deadline is forced to withdraw/retire and is examined by that event's Doctor and determined to be unfit for the following week's tournament; or
- ii) The player was on-site at the event when the withdrawal occurred and is determined to be unfit for play by that tournament's Doctor. Players who are examined by the on-site tournament Doctor shall receive tournament provided hotel rooms through the night of the examination.

*A withdrawal from Davis Cup must be from a "live" match, for medical reasons.

c) Promotional Activities.

A player who was not on-site when the withdrawal/late withdrawal occurred but travels to the tournament within the first three (3) days of the main draw, unless otherwise determined by ATP, and participates in a reasonable amount of promotional activities over a two (2) day period, as determined by ATP, shall not have the applicable fine and ranking penalties assessed. Players who travel to the event to complete their promotional activity requirement shall receive full hospitality from the day of arrival through the night following the completion of their promotional obligation.

d) Appeal.

The player may appeal the fine and ranking penalty to the Appeals Tribunal as specified below under "Review of Penalties for Entry and Commitment Offenses". See also ATP Tour 500 - Ranking Penalty, page 240.

- ### e) Replacement Event.
- A commitment player who has received a zero (0) point ranking penalty for withdrawing from an ATP Tour 500 event may replace the zero (0) point by playing an additional ATP Tour 500 event in that same calendar year for a total of four (4) played. The replacement tournament must be after the 500 withdrawal that has resulted in a ranking penalty. Only one (1) additional ATP Tour 500 event per year may be used to replace an ATP Tour 500 ranking penalty. See also ATP Tour 500 - Ranking Penalty, page 240.

3) ATP Tour Masters 1000

a) On-Site Medical Examination.

Players who withdraw after 10 AM Eastern Time, USA on Friday (or in the case of doubles, after the entry deadline) before a tournament shall not have the late withdrawal fine and the suspension assessed if determined to be unfit to play that week if:

- i) The player who is still competing in a tournament or Davis Cup* after the Friday 10 AM deadline is forced to withdraw/retire and is examined by that event's Doctor and determined to be unfit for the following week's tournament; or
- ii) The player was on-site at the event when the withdrawal occurred and is determined to be unfit for play by that tournament's Doctor. Players who are examined by the on-site tournament Doctor shall receive tournament provided hotel rooms through the night of the examination.

*A withdrawal from Davis Cup must be from a "live" match, for medical reasons.

VIII. THE CODE

b) Promotional Activities.

A player who was not on-site when the withdrawal/late withdrawal occurred but travels to the tournament within the first three (3) days of the main draw, unless otherwise determined by ATP, and participates in a reasonable amount of promotional activities over a two (2) day period, as determined by ATP, shall: (i) not have the applicable fine assessed, (ii) may recoup potential bonus pool money under Section 1.07.H.2 and (iii) shall not have the suspension penalties assessed. Players who travel to the event to complete their promotional activity requirement shall receive full hospitality from the day of arrival through the night following the completion of their promotional obligation.

c) Appeal.

The player may appeal the fine and suspension to the Appeals Tribunal as specified below under "Review of Penalties for Entry and Commitment Offenses".

d) Exceptions.

The player will not have the suspension assessed if he has grandfathered earned commitment reductions and withdraws prior to the withdrawal deadline and he did not withdraw in any manner from the same event the previous year. For the avoidance of doubt, the ranking penalty is automatic and unappealable regardless of any grandfathered ATP Masters 1000 exemptions.

4) ATP Challenger Tour/ATP Qualifying/ATP Challenger Tour Qualifying

a) Consecutive Withdrawals

- i) Players with multiple consecutive withdrawals* who are out of competition for 30 days or more due to injury will not be subject to a fine as long as verified and approved medical forms are provided.
- ii) A player must not compete in any other tennis event during those periods.
Note: The count shall begin on the withdrawal deadline date; the date of the retirement; the date of the late withdrawal; or the date of the on-site withdrawal, whichever was chronologically first.

*Each consecutive withdrawal must be prior to 10 AM on Friday, before the tournament.

b) On-Site Medical Examination.

Players who withdraw after 10 AM Eastern Time, USA on Friday (or in the case of doubles, after the entry deadline) before a tournament shall not have the late withdrawal fine assessed if determined to be unfit to play that week if:

- i) The player who is still competing in a tournament or Davis Cup* after the Friday 10 AM deadline is forced to withdraw/retire and is examined by that event's Doctor and determined to be unfit for the following week's tournament; or
- ii) The player is examined on-site, at the event from which he withdrew, and determined to be unfit for play by that tournament's Doctor during qualifying or within the first three (3) days of the main draw for Challengers/ATP Tour Qualifying. Players who are examined by the on-site tournament Doctor shall receive tournament provided hotel rooms through the night of the examination.

*A withdrawal from Davis Cup must be from a "live" match, for medical reasons.

c) Appeal.

The player may appeal the fine to the SVP - Rules and Competition as specified below under "Review of Penalties for Entry and Commitment Offenses".

VIII. THE CODE

No Penalty After Retirement

Case: A player is injured at an ATP Tour tournament and is forced to retire from his match. He is also unable to compete in the next week's tournament. The injury occurred after 10 AM, Friday, Eastern Time, USA. Must the player travel to the next tournament to be examined by that tournament's Doctor to avoid the appropriate penalties?

Decision: No. If the player is forced to retire after 10 AM, Friday, Eastern Time, USA, he may be examined by that tournament's Doctor.

J. Review of Penalties for Entry and Commitment Offenses

Any player found to have committed a United Cup, ATP Tour Masters 1000 or ATP Tour 500 entry or commitment offense may petition the Appeal Tribunal for discretionary review. ATP Tour 250, ATP Tour Qualifying and ATP Challenger Tour appeals shall be submitted to and determined by the ATP Senior Vice President – Rules and Competition. This written petition shall detail the basis for the appeal.

1) Deadline. The deadline for filing an appeal is as follows:

ATP Tour Masters 1000 - 6:00 PM Eastern USA on the Tuesday of the event week; except that:

96-draw tournaments shall be the first Thursday of the tournament week. If the Tribunal requests additional information, the player will have 24 hours from receipt of this notice to submit the requested information.

ATP Tour 500 - 10 days from the Monday of the event week.

If the Tribunal requests additional information, the player will have 48 hours from receipt of this notice to submit the requested information.

ATP Tour 250/ATP Tour Qualifying/ATP Challenger Tour - 10 days from the Monday of the event week.

If the SVP - Rules and Competition requests additional information, the player will have 48 hours from receipt of this notice to submit the requested information.

Appeals must be submitted in writing to the Appeals Tribunal/SVP - Rules and Competition and received prior to the deadline. Send electronically via email or fax to:

Miro Bratoev
Senior Vice President - Rules & Competition
201 ATP Tour Boulevard
Ponte Vedra Beach, Florida 32082 USA
Email: miro.bratoev@atptour.com

2) Determination. The Tribunal President/SVP - Rules and Competition shall review the petition and make a determination within the following time period:

ATP Tour Masters 1000 - 10 AM Eastern USA on the Friday* of the event week.

*For 96-draw tournaments, the determination shall be made by 10 AM Eastern USA on the 2nd Friday of the event.

ATP Tour 500 - 20 days from the Monday of the event week.

ATP Tour 250/ATP Tour Qualifying/ATP Challenger Tour - 20 days from the Monday of the event week.

VIII. THE CODE

3) Scope of determination. The Tribunal's/SVP - Rules and Competition decision on each case is limited to the following:

United Cup

Late Withdrawal Fine, if applicable

ATP Tour Masters 1000

Suspension

Late Withdrawal Fine, if applicable.

ATP Tour 500

Ranking penalty

Late Withdrawal Fine, if applicable.

ATP Tour 250/ATP Tour Qualifying/ATP Challenger Tour

Withdrawal Fine

Late Withdrawal Fine

K. Tribunal.

The ATP Board of Directors and ATP CEO shall nominate designees for the appeals tribunal as follows:

- 1) The three members of the board representing the players shall nominate a designee to serve a one (1) year term on the tribunal.
- 2) The three members of the board representing the tournaments shall nominate a designee to serve a one (1) year term on the tribunal.
- 3) The ATP CEO shall nominate a designee to serve a one (1) year term on the tribunal.
- 4) **Medical Advisor.**
 - a) A person nominated by the medical services committee shall be present, if requested by the three (3) voting members of the Tribunal, at all tribunal meetings to offer advice and expert opinion on medical matters presented to the Tribunal.
 - b) The advisor has no vote in any appeal decisions.

L. On-Site Offenses/Procedures

The on-site offense provisions shall apply to every player during his participation in an ATP Tour or ATP Challenger Tour tournament. On-site includes tournament hotels, transportation, all tournament facilities and activities.

1) Dress and Equipment

Every player shall dress and present himself for play in a professional manner. Clean and customarily acceptable tennis attire as approved by ATP shall be worn. A player who violates this section may be ordered by the Chair Umpire or Supervisor to change his attire or equipment immediately. Failure of a player to comply with such order may result in an immediate default.

a) Identification/Visible

No visible identification shall be permitted on a player, his clothing, products or equipment on court during a match or at any press conference or tournament ceremony, except as follows:

i) ATP Definitions.

1. **Clothing Designs.** Clothing designs will not be interpreted as manufacturer's logos and such logos can be incorporated into the clothing

VIII. THE CODE

design, provided they conform to the size and placement restrictions.

2. **Commercial Identification.** Corporate or product identification other than the manufacturer of the item, including social media usernames, hashtags, and URLs.
 3. **Tennis Equipment Manufacturer.** The tennis equipment manufacturer is the entity that distributes, or offers for sale, tennis racquets, clothing, strings or shoes.
 4. **Clothing Manufacturer.** Clothing manufacturer is the corporate or product identification, trademarks (regardless of registration status) or other recognizable names presented in the form of a logo or mark on the clothing product in question.
 5. **Size Limitation.**
 - If a patch, the size is determined by the area of the actual patch. If a solid color patch is the same color as the clothing, then the size of the actual patch will be determined by the size of the logo identification, as described below.
 - If not a patch, the area of a logo or mark shall be determined by the circumference of a circle or the perimeter of a triangle or rectangle drawn around the logo or mark.
- ii) **Logo Usage.** All logos or patches must be firmly attached at all points on the clothing or equipment. All commercial ID logos placed on the shirt front or collar must be embroidered or screen printed. All manufacturer logos must be embroidered, screen printed or otherwise professionally attached at all points.
1. **Bags, Towels or Other Items.** Standard logos of tennis equipment manufacturers on each item plus two (2) separate commercial identifications on one (1) bag, neither of which may exceed six (6) square inches (39 sq. cm.).
 2. **Drink Containers.** Players are permitted to use drink containers on-court if they are of reasonable size and they contain no logo or writing of the drink manufacturer. ATP has designated three (3) beverage categories of drinks for purposes of this rule: bottled water, electrolyte or other drinks. The Supervisor may approve for use on-court a reasonably sized drink container that has a logo or writing, not to exceed four (4) square inches (26 sq. cm.) if:
 - The center court drink sponsor is the same as the player's drink container manufacturer, or;
 - The advertised center court drink sponsor(s) is not in the same beverage category as the player's drink container.
 3. **Hat or Headband.** One (1) standard logo of a clothing manufacturer or a tennis equipment manufacturer and/or one (1) commercial identification, both of which may contain writing. Neither shall exceed four (4) square inches (26 sq. cm.).

Restrictions:

 - The commercial logo must be located on the side of the hat / headband and worn so that it is positioned on the side of the head;
 - No hat or headband, with or without logos, may be worn during the awards ceremony;
 - Once a player has competed in the first match of his first event with a commercial brand logo on his hat/headband then he may

VIII. THE CODE

not change commercial brands during that calendar year, unless approved by ATP.

Note: Players shall include a clause in their contracts permitting them to opt out at the end of any year in the event ATP rules change to prohibit a commercial brand logo on the hat or headband in the manner described above.

4. **Wristband.** One (1) standard logo of a clothing manufacturer or tennis equipment manufacturer, which may contain writing, not to exceed four (4) square inches (26 sq. cm.)
5. **Racquet.** Standard logos of the manufacturer shall be permitted on racquets and strings.
6. **Shirt, Sweater or Jacket.**
 - **Front, Back and Collar.** Two (2) standard logo positions of the clothing manufacturer or commercial ID, neither of which exceeds six (6) square inches (39 sq. cm.), may be placed in any location (i.e. 2 on the front, or 1 on the front and 1 on the collar) or one (1) logo of the clothing manufacturer or commercial ID which may not exceed six (6) square inches (39 sq. cm.), may be placed on the front or collar and then an additional clothing manufacturer logo, not to exceed four (4) square inches (26 sq. cm.), may be placed on the back. Logos may contain writing. Once a player has competed in the first match of his first event with a commercial brand logo on the front, collar or headgear, he may not change brands during that calendar year, unless approved by ATP. No new commercial logo may be added to the shirt front for events following the US Open through the Nitto ATP Finals.

Note: Players shall include a clause in their contracts permitting them to opt out at the end of any year in the event ATP rules change to prohibit a commercial brand logo on the front of a shirt, sweater or jacket in the manner described above.

ATP Premier / Platinum Sponsor Patch. An additional commercial identification patch may be placed on the back of the shirt, below the collar, if part of the ATP Premier / Platinum sponsor patch program. This program is optional and is in addition to any manufacturer identification on the back of the shirt.
 - **Sleeves.** Two positions for commercial (i.e., non-clothing manufacturer) or manufacturer's identification for each sleeve, neither of which exceeds six (6) square inches (39 sq. cm.). A maximum of two (2) logos may be placed within each 6 square inch (39 sq. cm.) position. Logos may contain writing.
 - **Sleeveless.** Two (2) logo positions of the clothing manufacturer or commercial ID none of which exceeds six (6) square inches (39 sq. cm.) may be placed on the front of the shirt. If no more than one (1) logo is placed on the front or collar of the shirt, then one (1) manufacturer logo may be placed on the back of the shirt, not to exceed four (4) square inches (26 sq. cm.).
 - **Other.** A logo of the clothing manufacturer, without the name of the manufacturer or any other writing, may be placed once or repeatedly within an area not to exceed twelve (12) square inches (77.5 sq. cm.) in one of the following positions:
 - a. On each of the shirt sleeves, or
 - b. On the outer seams (sides of torso) of the shirt.

VIII. THE CODE

7. Shorts.

- **Front and Back.** Two (2) standard logos of the clothing manufacturer neither of which exceeds two (2) square inches (13 sq. cm.), may be placed on the front or back of the shorts; or two (2) standard logos of the clothing manufacturer neither of which exceeds four (4) square inches (26 sq. cm.), may be placed as follows: one (1) logo on the front and one (1) logo on the back of the shorts. Logos may contain writing.
- Compression shorts and/or compression sleeves may contain two (2) standard logos of the clothing manufacturer which must not exceed two (2) square inches (13 sq. cm.) or one (1) standard logo of the clothing manufacturer which must not exceed four (4) square inches (26 sq. cm.).

8. **Socks /Shoes.** Standard logos of the manufacturer of the article may appear on each sock and each shoe.

Tattoo as Logo

Case: A player arrives on court wearing an approved sleeveless shirt. The Chair Umpire notices that the player has a tattoo of the clothing manufacturer on his upper arm. If there is no issue with the size, is this allowed?

Decision: No. The rules for both clothing manufacturer and commercial I.D. logo placement clearly specify where these logos may be placed.

- iii) **Restrictions /Government.** Any commercial or other identification that violates applicable governmental and/or television regulations is prohibited.
- iv) **Restrictions/Other Tennis event.** The identification by use of the name, emblem, logo, trademark, symbol or other description of any tennis circuit, series of tennis events, tennis exhibition or tournament other than the "ATP" is prohibited on all dress or equipment at any ATP Tour and ATP Challenger Tour tournaments, unless otherwise approved by ATP.
- v) **Restrictions /Timing.** Once a player has competed in the first match of his first event with a commercial brand logo in either of the two locations (shirt front and/or hat/headband), he may not change brands during that calendar year, unless approved by ATP.
- Note:** Players shall include a clause in their contracts permitting them to opt out at the end of any year in the event ATP rules change to prohibit a commercial brand logo on the front of a shirt, sweater or jacket in the manner described above.
- vi) **Restrictions / General.** Tobacco and companies associated with tennis gambling will be prohibited from any endorsements on player clothing. ATP reserves the right to prohibit any identification it deems not to be in the best interest of the game and/or ATP.

b) Shoes

- i) **General.** Players are required to wear tennis shoes generally accepted as proper tennis attire. Shoes shall not cause damage to the court other than what is expected during the normal course of a match or practice. Damage to a court may be considered as physical or visible, which may include a shoe that leaves marks beyond what is considered acceptable. The Supervisor has the authority to determine that a shoe does not meet the criteria of "customarily acceptable" and may order the player to change.

VIII. THE CODE

- ii) **Clay Courts.** Players are required to wear tennis shoes generally accepted for play on clay courts or granular surfaces. The Supervisor has the authority to determine that a tennis shoe's sole does not conform and can prohibit its use at any ATP Tour or ATP Challenger Tour tournament. Grass court shoes should not be worn during a match on clay courts.
- iii) **Grass Courts.** In ATP Tour and ATP Challenger Tour tournaments played on grass courts, no shoes other than those with rubber soles, without heels, ribs, studs or covering, shall be worn by players.
- aa) Special grass court shoes shall not be used without the express approval of ATP, based on the following specifications:
- 1) The pimples or studs on the base of the sole should be vertical from the outsole and shall have a maximum top diameter of three (3) millimeters and a minimum top diameter of two (2) millimeters. The maximum height of the pimples or studs shall be two (2) millimeters, from the base of the shoe. The hardness of any pimple or studs shall be between 55 and 60 based on a Shore "A" scale. The number of pimples per square inch shall be no less than 15 and no more than 28.
 - 2) Shoes with pimples or studs around the outside of the toes shall not be permitted. The foxing / sidewall can be contoured only in the medial forefoot and medial toe area but only within the following restrictions. The contoured area may begin in the transition area between outsole and sidewall but can only go to a maximum of 1.5 cm up the sidewall. This contoured area must be flat (not textured or undulating) but can be stepped with no more than 5 steps each no more than 1 mm in depth.
 - 3) Forefoot and heel areas may be separated but there should be no more than a 2 mm step in the outsole of the shoe.
 - Approval of special grass court shoes should be received by ATP at least ninety (90) days in advance of the grass court tournament.

All shoes approved for play in 2008 shall continue to be approved.

c) Violations/Fines

Any player who violates this section and is not defaulted shall be subject to the following fines:

- i) **Commercial Identification.** Violation of the provisions with respect to commercial identifications shall result in a fine up to:
- \$2,000 for ATP Challenger Tour tournaments.
 - \$30,000 for ATP Tour 250 tournaments.
 - \$40,000 for ATP Tour 500 tournaments.
 - \$60,000 for ATP Tour Masters 1000 tournaments.

The maximum fine will increase by one hundred percent (100%) for each consecutive violation during the same calendar year.

ii) **Tennis Equipment Manufacturer's logo.** Violation of the provisions with respect to standard logos of manufacturers shall result in a fine up to:

- \$500 for ATP Challenger Tour tournaments.
- \$30,000 for ATP Tour 250 tournaments.
- \$40,000 for ATP Tour 500 tournaments.
- \$60,000 for ATP Tour Masters 1000 tournaments.

The maximum fine will increase by one hundred percent (100%) for each consecutive violation during the same calendar year.

VIII. THE CODE

iii) **Other Tennis event.** Violation of the provisions with respect to the name of an event other than the "ATP" shall result in a fine up to:

- \$5,000 for ATP Challenger Tour tournaments.
- \$30,000 for ATP Tour 250 tournaments.
- \$40,000 for ATP Tour 500 tournaments.
- \$60,000 for ATP Tour Masters 1000 tournaments.

The maximum fine will increase by one hundred percent (100%) for each consecutive violation during the same calendar year.

iv) **Unacceptable Attire.** Violation of the provisions with respect to unacceptable attire shall result in a fine up to:

- \$1,000 for ATP Challenger Tour tournaments
- \$30,000 for ATP Tour 250 tournaments.
- \$40,000 for ATP Tour 500 tournaments.
- \$60,000 for ATP Tour Masters 1000 tournaments.

The maximum fine will increase by one hundred percent (100%) for each consecutive violation during the same calendar year.

2) Point Penalty Schedule

a) The Point Penalty Schedule to be used for Code Violations is as follows:

FIRST OFFENSE	WARNING
SECOND OFFENSE	POINT PENALTY
THIRD AND EACH SUBSEQUENT OFFENSE	GAME PENALTY

However, after the third Code Violation, the Supervisor shall determine whether each subsequent offense shall constitute a default.

b) In ATP Tour and ATP Challenger Tour tournaments and events, Code Violations shall be levied by the Chair Umpire for on-court offenses. In the event that the Chair Umpire fails to levy a code violation, then the Supervisor may order him to do so.

c) In doubles, code violations shall be assessed against the team.

3) Code Violations Not Witnessed By Chair Umpire

Occasionally, there are code violations by players that are not witnessed by the Chair Umpire. The Line Umpire should immediately approach the Chair Umpire and report the facts of the violation, during which time the Chair Umpire should turn off all microphones in the area of the chair. The Chair Umpire may ask the player to respond to such report; thereafter, the Chair Umpire must make a decision and he either dismisses the report or declares a code violation and assesses a penalty. If a code violation is assessed, then the Chair Umpire must announce such violation to the player, opponent and spectators. If in his opinion there was a code violation, but because of the time of discovery (another point has been played), it would be inappropriate to issue a Code Violation Warning, Point or Game Penalty, then he/she must notify the player that he/she will refer the matter to the Supervisor for action after the match. If a serious violation that may warrant an Immediate Default has been reported and acted upon no later than the end of the next changeover, the ATP Supervisor may be called to discuss an Immediate Default. The Supervisor may order the Chair Umpire to issue a code violation for a violation witnessed or not witnessed by the Chair Umpire.

Case 1: A Line Umpire reports to the Chair Umpire an incident which occurred three (3) points earlier, may the Chair Umpire issue a Warning, Point or Game Penalty?

Decision 1: No, in this case a Code Violation may be issued only if the violation was reported immediately (before the next point is played).

VIII. THE CODE

Case 2: Same situation as Case 1 above except that the violation reported is a serious violation that may warrant an Immediate Default. May the Supervisor/Referee be called to discuss an Immediate Default?

Decision 2: Yes, as long as the violation has been reported and acted upon no later than the end of the next changeover. Once the first point of the game immediately following the changeover has been played then no Code Violation for an Immediate Default may be issued. The player may however be subject to a fine as determined by the Supervisor.

4) Offenses

a) Ball Abuse

i) Players shall not violently, dangerously or with anger hit, kick or throw a tennis ball while on the grounds of the tournament site except in the reasonable pursuit of a point during a match (including warm-up). For purposes of this rule, abuse of balls is defined as intentionally or recklessly hitting a ball out of the enclosure of the court, hitting a ball dangerously or recklessly within the court or hitting a ball with disregard of the consequences.

ii) Violation of this section shall subject a player to a fine of up to \$350 for each violation. In addition, if such violation occurs during a match, the player shall be penalized in accordance with the Point Penalty Schedule.

b) Racquet or Equipment Abuse

i) Players shall not violently, dangerously or with anger hit, kick or throw a racquet or other equipment within the precincts of the tournament site. For purposes of this rule, abuse of racquets or equipment is defined as intentionally, dangerously and violently destroying or damaging racquets or equipment or intentionally and violently hitting the net, court, umpire's chair or other fixture during a match out of anger or frustration.

ii) Violation of this section shall subject a player to a fine up to \$500 for each violation. In addition, if such violation occurs during a match, the player shall be penalized in accordance with the Point Penalty Schedule.

c) Physical Abuse

i) Players shall not at any time physically abuse any official, opponent, spectator or other person within the precincts of the tournament site. For purposes of this rule, physical abuse is the unauthorized touching of an official, opponent, and spectator or other person.

ii) Violation of this section shall subject a player to a fine up to \$20,000 for ATP Challenger Tour tournaments, \$30,000 for ATP Tour 250 tournaments, \$40,000 for ATP Tour 500 tournaments, \$60,000 for ATP Tour Masters 1000 tournaments for each violation. The maximum fine will increase by one hundred percent (100%) for each consecutive violation during the same calendar year. In addition, if such violation occurs during a match, the player shall be penalized in accordance with the Point Penalty Schedule. In circumstances that are flagrant and particularly injurious to the success of a tournament, or are singularly egregious, the ATP Supervisor may refer the matter to the ATP Fines Committee who shall conduct an investigation to determine whether the player Major Offense of Aggravated Behavior or Conduct Contrary to the Integrity of the Game has occurred. Prize money earned at that event shall be held by ATP until

VIII. THE CODE

the ATP Fines Committee has concluded their investigation and made a determination.

d) Verbal Abuse

- i) Players shall not at any time directly or indirectly verbally abuse an official, opponent, sponsor, spectator or any other person within the precincts of the tournament site. Verbal abuse is defined as any statement about an official, opponent, sponsor, spectator or any other person that implies dishonesty or is derogatory, insulting or otherwise abusive.
- ii) Violation of this section shall subject a player to a fine up to \$20,000 for ATP Challenger Tour tournaments, \$30,000 for ATP Tour 250 tournaments, \$40,000 for ATP Tour 500 tournaments, \$60,000 for ATP Tour Masters 1000 tournaments for each violation. The maximum fine will increase by one hundred percent (100%) for each consecutive violation during the same calendar year. In addition, if such violation occurs during a match, the player shall be penalized in accordance with the Point Penalty Schedule. In circumstances that are flagrant and particularly injurious to the success of a tournament, or are singularly egregious, the ATP Supervisor may refer the matter to the ATP Fines Committee who shall conduct an investigation to determine whether the player Major Offense of Aggravated Behavior or Conduct Contrary to the Integrity of the Game has occurred. Prize money earned at that event shall be held by ATP until the ATP Fines Committee has concluded their investigation and made a determination.

e) Audible Obscenity

- i) A player shall not use an audible obscenity while on-site. Audible obscenity is defined as the use of words commonly known and understood to be profane and uttered clearly and loudly enough to be heard.
- ii) Violation of this section shall subject a player to a fine up to \$5,000 for each violation. In addition, if such violation occurs during a match, the player shall be penalized in accordance with the Point Penalty Schedule. In circumstances that are flagrant and particularly injurious to the success of a tournament, or are singularly egregious, a single violation of this section shall also constitute the player Major Offense of Aggravated Behavior.

f) Visible Obscenity

- i) Players shall not make obscene gestures of any kind while on-site. Visible obscenity is defined as the making of signs by a player with hands and/or racquet or balls that commonly have an obscene meaning.
- ii) Violation of this section shall subject a player to a fine up to \$5,000 for each violation. In addition, if such violation occurs during a match, the player shall be penalized in accordance with the Point Penalty Schedule. In circumstances that are flagrant and particularly injurious to the success of a tournament, or are singularly egregious, a single violation of this section shall also constitute the player Major Offense of Aggravated Behavior.

g) Unsportsmanlike Conduct

- i) Players shall at all times conduct themselves in a sportsmanlike manner and give due regard to the authority of officials and the rights of opponents, spectators and others. Unsportsmanlike conduct is defined as any misconduct by a player that is clearly abusive or detrimental to the success of a tournament, ATP and/or the Sport. In addition, unsportsmanlike conduct shall include, but not be limited to, the giving, making, issuing,

VIII. THE CODE

authorizing or endorsing any public statement having, or designed to have, an effect prejudicial or detrimental to the best interest of the tournament and/or the officiating thereof.

- ii) Players and their support team members accredited at any event must comply with the physical distancing and COVID-19 precautionary measures applicable for each event. Any repetitive or blatant breach of those measures may be considered a violation of the code of conduct under this Section or the Major Offense of Conduct Contrary to the Integrity of the Game depending on the severity of the violation.
 - iii) Violation of this section shall subject a player to a fine up to \$20,000 for ATP Challenger Tour tournaments, \$30,000 for ATP Tour 250 tournaments, \$40,000 for ATP Tour 500 tournaments, \$60,000 for ATP Tour Masters 1000 tournaments for each violation. The maximum fine will increase by one hundred percent (100%) for each consecutive violation during the same calendar year. In addition, if such violation occurs during a match, the player shall be penalized in accordance with the Point Penalty Schedule. In circumstances that are flagrant and particularly injurious to the success of a tournament, or are singularly egregious, the ATP Supervisor may refer the matter to the ATP Fines Committee who shall conduct an investigation to determine whether the player Major Offense of Aggravated Behavior or Conduct Contrary to the Integrity of the Game has occurred. Prize money earned at that event shall be held by ATP until the ATP Fines Committee has concluded their investigation and made a determination.
- ### h) Best Efforts
- i) A player shall use his best efforts during the match when competing in a tournament. Violation of this section shall subject a player to a fine up to \$20,000 for ATP Challenger Tour tournaments, \$30,000 for ATP Tour 250 tournaments, \$40,000 for ATP Tour 500 tournaments, \$60,000 for ATP Tour Masters 1000 tournaments for each violation. The maximum fine will increase by one hundred percent (100%) for each consecutive violation during the same calendar year.
 - ii) For purposes of this rule, the Supervisor and/or the Chair Umpire shall have the authority to penalize a player in accordance with the Point Penalty Schedule. In circumstances that are flagrant and particularly injurious to the success of a tournament, or are singularly egregious, the ATP Supervisor may refer the matter to the ATP Fines Committee who shall conduct an investigation to determine whether the player Major Offense of Aggravated Behavior or Conduct Contrary to the Integrity of the Game has occurred. Prize money earned at that event shall be held by ATP until the ATP Fines Committee has concluded their investigation and made a determination.
- ### i) Leaving the Court
- i) A player shall not leave the court area during a match (including the warm-up) without the permission of the Chair Umpire or Supervisor.
 - ii) Violation of this section shall subject a player to a fine up to \$3,000 for ATP Challenger Tour tournaments, \$30,000 for ATP Tour 250 tournaments, \$40,000 for ATP Tour 500 tournaments, \$60,000 for ATP Tour Masters 1000 tournaments for each violation. The maximum fine will increase by one hundred percent (100%) for each consecutive violation during the same calendar year. In addition, the player may be defaulted and shall be subject to the additional penalties for failure to complete match.

VIII. THE CODE

j) Failure to Complete Match

- i) A player must complete a match in progress unless he is reasonably unable to do so.
- ii) Violation of this section shall subject a player to a fine up to \$5,000 for ATP Challenger Tour tournaments, \$30,000 for ATP Tour 250 tournaments, \$40,000 for ATP Tour 500 tournaments, \$60,000 for ATP Tour Masters 1000 tournaments. The maximum fine will increase by one hundred percent (100%) for each consecutive violation during the same calendar year. Violation of this section shall subject a player to immediate default and shall also constitute the Major Offense of Aggravated Behavior.

k) Ceremonies

- i) All tournament finalists must attend and participate in the post-match ceremonies, unless he is physically unable to do so as determined by the tournament Doctor. This includes retirements and finals not played due to a walkover.
- ii) Violation of this section shall subject a player to a fine up to \$5,000.

l) Coaching and Coaches

- i) Players shall not receive coaching during a tournament match*. Communications of any kind, audible or visible, between a player and a coach may be construed as coaching. Coaches on-site are prohibited from:
 - aa) Using an audible obscenity or making obscene gestures of any kind.
 - bb) Abusing any official, opponent, spectator or other person, verbally or physically.
 - cc) Engaging in conduct contrary to the integrity of the game of tennis. Conduct contrary to the integrity of the game shall include, but not be limited to, comments to the news media that unreasonably attack or disparage a tournament, sponsor, player, official or ATP. Responsible expressions of legitimate disagreement with ATP policies are not prohibited. However, public comments that one of the stated persons above knows, or should reasonably know, will harm the reputation or financial best interest of a tournament, player, sponsor, official or ATP are expressly covered by this section.
- ii) Violation of this section shall subject a player to a fine up to \$5,000 for each violation. In addition, if such violation occurs during a match, the player shall be penalized in accordance with the Point Penalty Schedule. In circumstances that are flagrant and particularly injurious to the success of a tournament, or are singularly egregious, the Supervisor shall have the authority to relocate the position of a coach if there is reasonable belief that coaching is occurring or the Supervisor may order the coach to be removed from the match site or tournament site and upon his failure to comply with such order, may declare an immediate default of such player.

*Coaching is allowed at ATP Tour and Challenger Tour tournaments through the end of 2023 on a trial basis with the following conditions:

- The coach must sit in the tournament's designated coaches' seats
- Verbal coaching is permitted only when the player is at the same end of the court
- Verbal coaching may consist of a few words and/or short phrases (no conversations are permitted)
- Non-verbal coaching (hand signals) is permitted

VIII. THE CODE

- Coaching (verbal and non-verbal) is allowed only if it does not interrupt play or create any hindrance to the opponent
- Players may approach their coach or engage in conversation with their coach ONLY during the opposing player's Medical Timeout or a Toilet Break/Change of Attire Break
- Coaches may not speak to their player, when the player leaves the court for any reason
- Penalties and fines to apply for abuse or misuse of the coaching conditions

Electronic devices

Case: May a player listen to an mp3 player or other device on a changeover?

Decision: A player is not allowed to use any electronic devices (e.g. CD players, mobile phones, etc.) during matches, unless approved by the Supervisor. (Tour Policy)

m) Default

- i) **During the match.** The Supervisor may default a player either for a single violation of the Code (immediate default) or as outlined in the Point Penalty Schedule.
- ii) **On-site.** The Supervisor may withdraw a player from all events for a single violation of the Code occurring during the event but not during a player's match.
- iii) In all cases of default, the Supervisor's decision shall be final and may not be appealed.
- iv) **Penalties:**
 - aa) Any player who is defaulted shall lose all prize money (gross prize money to be paid to ATP), hotel accommodations and points earned for that event at that tournament.
 - bb) At the discretion of the Supervisor, the player may be withdrawn from all other events, if any, in that tournament.
 - cc) In addition, if the Senior Vice President - Rules & Competition determines that the default was particularly injurious to the success of the tournament or detrimental to the integrity of the sport, he may consider additional penalties (fines and/or suspensions).
- v) The exception is when the offending incident involves:
 - aa) A violation of the punctuality or dress and equipment provisions set forth in the Code; or
 - bb) As a result of a medical condition; or
 - cc) A match ending on a delay penalty (Code Violation for Delay of Game) if the delay penalty was the result of a medical condition.
 - dd) A member of a doubles team did not cause any of the misconduct code violations that resulted in the team being defaulted.
- vi) **In doubles:**
 - aa) A default assessed for violation of the Code shall be assessed against the team.
 - bb) The Supervisor will assess the default penalties against both players on the team, unless the provisions in 4 above apply.
 - cc) At the discretion of the Supervisor, one or both of the players may be withdrawn from all other events, if any, in that tournament.
 - dd) The partner of the player who caused the default shall receive points and prize money from the previous round.

VIII. THE CODE

Default - List Penalties

Case: If a player is defaulted through the Code of Conduct for misconduct, what penalties result?

Decision: The player may be withdrawn from any other event he is entered in, as determined by the Supervisor; lose all points and gross prize money earned for the event where he was defaulted; and hotel accommodations, in addition to the fines that may be imposed for the code violations. If the player is removed from the other event as well, he will lose all points and prize money earned from both events, and hotel accommodations.

n) Punctuality

Players shall be ready to play when their matches are called.

- i) Any player not ready to play within ten (10) minutes after his match is called shall be fined \$250.
- ii) For televised matches with an announced “walk-on” time, players not ready to walk-on at the announced time may be issued a fine at the sole discretion of the ATP Supervisor. Normal fines may be in the range of \$1,000-\$5,000 but in extreme cases could be up to a maximum of \$10,000.
- iii) Any player not ready to play within fifteen (15) minutes after his match is called may be fined up to an additional \$750 and shall be defaulted unless the Supervisor, after consideration of all relevant circumstances, elects not to declare a default. In such case, the Supervisor shall immediately inform the Senior Vice President - Rules & Competition. This section applies only to those players who are or have been on-site.

Late Transportation

Case: The scheduled transportation is late to pick up players from the tournament hotel. A player is defaulted for punctuality and subsequently arrives on-site with tournament transportation. Should the default be rescinded and the match played?

Decision: The player is defaulted. Transportation is a service provided by the tournament; however, the player is responsible for arriving on time for his match.

o) Continuous Play

- i) **Delay of Play.** A player will receive a warning for the first violation and be subject to a fine for each subsequent violation (\$250 then doubled for each additional violation) during that week’s event for violating the following timings:

Action	Time Allowed	
	ATP Tour	ATP Challenger
Reaching the net for the pre-match meeting. Timing begins when second player/team reaches the appropriate bench.	60 seconds	60 seconds
Warm-up. Time begins at the conclusion of the pre-match meeting.	4 minutes	5 minutes

VIII. THE CODE

Time Allowed		
Start of play. Players must show that they are ready to start play. Timing begins at the conclusion of the 4 or 5 minute warm-up.	60 seconds	60 seconds

- ii) **Delay of Game.** Once the match has begun, play shall be continuous and a player shall not unreasonably delay a match for any cause. A maximum of twenty-five (25) seconds shall elapse from the moment the ball goes out of play until the time the ball is struck for the next point. If such serve is a fault, then the second serve must be struck by the server without delay. The exception is at a ninety (90) second changeover or a one hundred twenty (120) set break. The procedures for enforcing this rule are as follows:

aa) 25 Seconds Between Points.

- 1) Start stopwatch when the player is ordered to play or when the ball goes out of play.
- 2) Assess time violation or code violation if the ball is not struck for the next point within the twenty-five (25) seconds allowed. There is no time warning prior to the expiration of the twenty-five (25) seconds.

bb) Changeover (Ninety (90) Seconds) and Set Break (One Hundred and Twenty (120) Seconds).

- 1) Start stopwatch the moment the ball goes out of play.
- 2) Announce “Time” after sixty (60) / ninety (90) seconds have elapsed.
- 3) Announce “15 Seconds” if one or both of the players are still at their chairs and/or have not started toward their playing positions after seventy-five (75) / one hundred and five (105) seconds have elapsed.
- 4) Assess time violation or code violation (after medical time-out or treatment) if the ball is not struck for the next point within the ninety (90) / one hundred and twenty (120) seconds allowed provided there has been no interference which prevented the server from serving within that time.

NOTE: When requested by television, “Time” shall be announced after ninety (90) seconds for a changeover and one hundred twenty (120) seconds for a set break.

cc) Time Violations.

Violating a provision of this Section, as server or receiver, shall be penalized by a “Time Violation – Warning” and each subsequent violation shall be penalized as follows:

- **Server.** When serving the time violation shall result in a “fault”.
- **Receiver.** When it is determined that the receiver is the cause of the time violation, then the receiver shall be penalized by the assessment of one (1) point penalty. The receiver must also play to the reasonable pace of the server. A Time Violation may be issued in this case prior to the expiration of twenty-five (25) seconds if the receiver’s actions are delaying the reasonable pace of the server. Assess a code violation if the receiver is con-

VIII. THE CODE

sistently or obviously delaying the server, thus employing “Unsportsmanlike Conduct”.

- **Server/Receiver** following a toilet break. Point Penalty.

Note: A second time violation occurs when a player who has received a prior warning as either the server or receiver is issued another time violation as either server or receiver. Example is Player A had received a warning for not serving within the 25 second limit; later, as receiver, Player A is deemed to not be playing to the reasonable pace of the server. This would be considered a second violation and a point penalty would be issued.

p) **Post-Match Media Availability**

- All players scheduled to play on televised courts will be required, if requested, to perform a pre-match TV interview on the day of the match (not to exceed 2 minutes in total). The interview may be conducted at either the player’s practice court or as the players approach the court for walk-on as determined by the host and player’s national broadcasters.
- Unless injured and physically unable to appear, a player or team must be available, as determined by ATP, on court (for TVs only), in the mixed zone or media conference area after the conclusion of each match whether the player or team was the winner or loser. Post-match media obligations include three (3) interviews, with the news service, host and player’s national broadcasters. This rule shall also apply to matches won or lost as a result of a withdrawal or retirement.
- Violation of this section shall subject a player to a fine in accordance with the following schedule (based on most recent position in the Pepperstone ATP Rankings):

1 - 10	\$20,000
11 - 25	\$10,000
26 - 50	\$5,000
51 - 100	\$3,000
101 +	\$1,000

Fines will be increased to the next higher level for any national player. Fines will double for each repeat offense within an ATP Circuit Year.

For ATP Challenger Tour events, a violation of this section shall result in a fine of \$500.

q) **Pre-Tournament Media Availability**

All players will be required, if requested, to take part in media availability prior to their first match at each tournament.

r) **ATP STARS Program Penalties**

Players shall be required to participate in ATP sponsored activities at each ATP Tour tournament. Failure to participate in a scheduled activity due to non-appearance or tardiness shall be deemed a missed activity. Violation of this section shall subject a player to a fine as indicated below:

Fine Schedule (based on most recent position in the Pepperstone ATP Rankings):

VIII. THE CODE

1 - 10	\$20,000
11 - 25	\$10,000
26 - 50	\$5,000
51 - 100	\$3,000
101 +	\$1,000

Fines will be increased to the next higher level for any national player. Fines will double for each repeat offense within an ATP Circuit Year.

s) **Champion’s Media Tour**

Each winner of a Grand Slam or the Nitto ATP Finals, if requested, is obligated to participate in media tour as arranged by ATP during the days immediately following the finals of any such tournament. Players and their agents will be consulted with respect to the scope and substance of the activities to take place during the media tour to ensure that the player is comfortable with the proposed activities. ATP will cover all expenses incurred by a player while participating in the media tour.

t) **Special Functions**

Each player, if requested, is obligated to attend the ATP Awards Show and up to two (2) additional ATP sponsored/conducted special events. Players and their agents will be consulted in advance to ensure that attendance at any such event(s) will not substantially intrude upon the player’s schedule. Players and their agents will also be consulted with respect to the scope and substance of the events to ensure that the player is comfortable with attending the event(s).

M. Determination of Violation and Penalty

- The Supervisor shall make a reasonable investigation to determine the facts regarding all player on-site offenses. Upon determining that a violation has occurred, the Supervisor shall specify the fine and/or other punishment in written notice to the player. The Supervisor may limit the fines levied during qualifying competition as follows:
 - ATP Tour Tournament Qualifying Competition. A maximum of \$500 for each violation.
 - ATP Challenger Tour Tournament Qualifying Competition. A maximum of \$100 for each violation.
- The ATP Fines Committee shall have the authority to investigate statements or actions made by a player that are not heard or seen by on-court officials by reviewing tapes of televised matches. After reviewing all facts and circumstances, the ATP Fines Committee may determine that a violation of the Code has occurred and shall specify the fine and/or other punishment. The player shall be given written notice of the violation and fine. The player shall have the right to appeal such determination to the ATP Senior Vice President - Rules & Competition, consistent with the procedures outlined in the Code.

N. Payment of Fines

Fines levied by the Supervisor for player on-site offenses shall be paid in accordance with the following:

VIII. THE CODE

- 1) **ATP Tour and ATP Challenger Tour Tournaments.** Each tournament shall deduct fines from the player's winnings, if any, and promptly pay the fine to ATP. In the event that the player's winnings are insufficient to pay the fine, the player shall pay the balance within twenty (20) days after the tournament to ATP.

O. Procedures for Appeal

- 1) Except for appeals of violations of the Stars Program, any player in violation of a player on-site offense may, after paying all fines, appeal to the ATP Fines Committee for review of a determination of guilt and the penalty assessed.
- 2) Any player found to have committed a player on-site offense may appeal such decision in writing to the ATP Fines Committee. Such appeal shall be lodged within ten (10) days of the on-site offense. The ATP Fines Committee shall review the Appeal within twenty-one (21) days and, if necessary, designate a date, time and place for a hearing. At the hearing, the player shall present to the ATP Fines Committee his respective positions on the facts. The ATP Fines Committee may affirm, reverse or modify the penalty initially imposed by the Supervisor.

P. Appeal of Violations of STARS Program

- 1) All appeals concerning the ATP STARS Program shall be governed by the procedures in this section.
- 2) A player can file a written appeal with the Senior Vice President - Rules & Competition within ten (10) days after the player's receipt of notification of a violation of the Stars Program. As a condition to filing an appeal, the player must pay the fine prescribed in the Program for the violation.
- 3) Upon receipt of a timely written appeal, the Senior Vice President - Rules & Competition, or his designee, shall appoint a committee to hear and decide the appeal, and also shall appoint one of the committee members to act as the committee's chairman. ATP may provide reasonable compensation and reimbursement of expenses to committee members.
- 4) The committee shall convene a hearing to hear the appeal and shall render its written decision on the case as soon as practicable following the conclusion of the hearing. The decision shall be by majority of the committee members.
- 5) The procedure prior to and at the hearing shall be at the discretion of the committee chairman, including but not limited to the decision to conduct the hearing by telephone conference or in person. In establishing such procedures, the chairman shall take into account the amount of the fine involved and any other relevant considerations.
- 6) The committee shall not be bound by judicial rules governing the procedure or the admissibility of evidence, provided that the hearing is conducted in a fair manner with a reasonable opportunity for each party to submit evidence, address the committee and present his or its case.
- 7) In all appeals, ATP will appear and defend the finding of a violation, and shall have the burden of proving, by a preponderance of the evidence, that there has been a violation of the STARS Program.
- 8) The committee's decision shall be the full, final and complete disposition of the appeal and will be binding on all parties.

VIII. THE CODE

- 9) If the player's appeal is upheld, the Senior Vice President - Rules & Competition shall refund to the player the fine paid by the player in connection with this appeal.

Q. Notice and Service

- 1) Any written communication to be sent to the ATP CEO or Senior Vice President - Rules & Competition should be addressed as follows, unless notice of change is subsequently published.
ATP Fines Committee or SVP - Rules & Competition
ATP Americas
201 ATP Blvd
Ponte Vedra Beach, FL 32082, USA
Telephone: +1 904 285 8000
- 2) **Service.** Service to a player of any notice or other document shall be deemed completed if mailed to the player at his home address or other address designated by the player.

8.05 Player Major Offenses/Procedures

A. Offenses

1) Aggravated Behavior

- a) No player, their coaches, Physiotherapist, therapist, physician, management representative, agent, family member, tournament guest, business associate or other affiliate or associate of any player ("Related Persons"), or any other person who receives accreditation at an Event at the request of the player or any other Related Person, at any ATP Tour or ATP Challenger Tour tournament shall engage in aggravated behavior which is defined as follows:
 - i) One or more incidents of behavior designated in this Code as constituting aggravated behavior.
 - ii) One incident of behavior that is flagrant and particularly injurious to the success of a tournament, or is singularly egregious, including the sale of credentials.
 - iii) A series of two (2) or more violations of this Code within a twelve (12) month period which singularly do not constitute aggravated behavior, but when viewed together establish a pattern of conduct that is collectively egregious and is detrimental or injurious to ATP Tour or ATP Challenger Tour tournaments.
- b) Violation of this section shall subject a player to a fine up to \$100,000 or the amount of prize money won at the tournament, whichever is greater, and/or suspension from play in ATP Tour and ATP Challenger Tour tournaments or events for a minimum period of twenty-one (21) days and a maximum period of one (1) year. The suspension shall commence on the Monday after the expiration of the time within which an appeal may be filed, or, in the case of appeal, commencing on the Monday after a final decision on appeal. Violation of this Section by a Related Person may result in a maximum penalty of permanent revocation of accreditation and denial of access to all ATP Tour and ATP Challenger Tour Tournaments.

2) Conduct Contrary to the Integrity of the Game

The favorable reputation of ATP, its tournaments and players is a valuable asset and creates tangible benefits for all ATP members. Accordingly, it is an obligation

VIII. THE CODE

for ATP players and Related Persons, to refrain from engaging in conduct contrary to the integrity of the game of tennis.

- a) Conduct contrary to the integrity of the game shall include, but not be limited to, publicized comments that unreasonably attack or disparage any person or group of people, a tournament, sponsor, player, official or ATP. Responsible expressions of legitimate disagreement with ATP policies are not prohibited. However, public comments that one of the stated persons above knows, or should reasonably know, will harm the reputation or financial best interests of a tournament, player, sponsor, official or ATP are expressly covered by this section.
- b) A player, or related person, that has at any time behaved in a manner severely damaging to the reputation of the sport, including submitting a falsified Covid-19 vaccination record, may be deemed by virtue of such behavior to have engaged in conduct contrary to the integrity of the Game of Tennis and be in violation of this Section.
- c) A player, or related person, convicted of a violation of a criminal or civil law of any jurisdiction may be deemed by virtue of such conviction to have engaged in conduct contrary to the integrity of the Game of Tennis.
- d) A player, or related person, charged with a violation of a criminal or civil law of any jurisdiction may be deemed by virtue of such charge to have engaged in conduct contrary to the integrity of the Game of Tennis and the ATP Fines Committee may provisionally suspend such player, or related person, from further participation in ATP tournaments pending a final determination of the criminal or civil proceeding.
- e) Violation of this section shall subject the player to a fine of up to \$250,000 and/or suspension from play in ATP Tour or ATP Challenger Tour tournaments for a period of up to three (3) years. Violation of this Section by a Related Person may result in a maximum penalty of permanent revocation of accreditation and denial of access to all ATP Tour and ATP Challenger Tour Tournaments.

3) Prohibited Promotional Fees

- a) ATP Tour 500 and 250 tournaments have the option to offer fees for promotional services. No other ATP Tour or ATP Challenger Tour tournament owner, operator, sponsor or agent is permitted to offer, give or pay money or anything of value, nor shall the tournament permit any other person or entity to offer, give or pay money or anything of value to a player, directly or indirectly, to influence or assure a player's competing in a tournament, other than prize money, unless authorized to do so by ATP.
- b) Violation of this section shall subject the player to a fine up to \$20,000 for ATP Challenger Tour tournaments, \$30,000 for ATP Tour 250 tournaments, \$40,000 for ATP Tour 500 tournaments, \$60,000 for ATP Tour Masters 1000 tournaments plus the amount of value of any such payment, and/or to suspensions from play in ATP Tour and ATP Challenger Tour tournaments for a period of up to three (3) years. The suspension shall begin on the Monday after the expiration of the time within which an appeal may be filed, or, in the case of appeal, commencing on the Monday after a final decision on appeal. The maximum fine will increase by one hundred percent (100%) for each consecutive violation during the same calendar year.
- c) If the ATP Fines Committee believes that a player may be violating this section, then upon demand, the player or his agent, must furnish or provide access to the ATP Fines Committee copies of all records relating to their par-

VIII. THE CODE

ticipation in or, in the absence of such records, an affidavit setting forth the facts with respect to any transaction in question. In the event a player fails to provide the records or affidavit, the ATP Fines Committee may suspend him from participation in ATP Tour and ATP Challenger Tour tournaments pending compliance with such demand.

B. Procedures

1) Determination and Penalty

The ATP Fines Committee shall conduct such investigation of an alleged player major offense as they, in their sole discretion, determine is appropriate and necessary. Upon completion of their investigation, the ATP Fines Committee shall determine whether a player major offense has occurred and, if so, shall fix a penalty to be imposed. A copy of the decision setting forth such penalty shall be promptly delivered to the player.

2) Payment of Fines

The player shall pay all fines levied for player major offenses to ATP by delivery to the ATP Fines Committee within twenty-one (21) days after receiving written notice.

3) Appeal

Any player who has received a penalty for a player major offense may, after paying all monetary fines, appeal such determination by filing a written notice with the ATP Senior Vice President - Rules & Competition within five (5) days (excluding weekends) of such player's receipt of notice of such determination. Upon receiving such notice of appeal, the ATP Senior Vice President - Rules & Competition or his designee shall set a date and place for the hearing.

4) Hearing on Appeal

The ATP Senior Vice President - Rules & Competition or his designee shall conduct the hearing on appeal in accordance with the following:

- a) **Burden of Proof.** The ATP Fines Committee has the responsibility to prove the violation by a preponderance of the evidence.
- b) **Rules.** The ATP Senior Vice President - Rules & Competition or his designee must conduct the hearing in a fair and orderly manner with opportunity for each side to present its evidence as to the facts involved, and the player and his representative, if any, and the ATP Fines Committee are bound to cooperate fully to this end.
- c) **Statement of Position.** The ATP Senior Vice President - Rules & Competition or his designee may request the ATP Fines Committee and the player to state in writing their respective positions on the facts, the provision(s) of the Code allegedly violated and the penalty specified and file the same with the ATP Senior Vice President - Rules & Competition or his designee at least three (3) days prior to the hearing, with a copy to each other.
- d) **Presentation.** The ATP Fines Committee and the player may present evidence personally or through counsel. Each party shall have the right to present and to cross-examine witnesses, and to offer documentary evidence and testimony by affidavit or deposition. Except for purposes of rebuttal, documentary evidence and affidavits shall not be admissible unless a copy is submitted at least three (3) days prior to the hearing to the ATP Senior Vice President - Rules & Competition or his designee and to the other party.

VIII. THE CODE

Should objection be made to the introduction of an affidavit, the ATP Senior Vice President - Rules & Competition or his designee may determine in his discretion that the interests of fairness require that the individual be produced to testify at the hearing, or alternatively, that such affidavit be excluded. In the case of the former, a reasonable continuance may be granted for production of such witness.

- e) **Hearing.** The hearing shall be closed to the public. Once commenced, the hearing shall continue from day to day until concluded, unless the ATP Senior Vice President - Rules & Competition or his designee allows otherwise. Postponements, adjournments or any form of delay shall be permitted only in the case of documented emergency and at the sole discretion of the ATP Senior Vice President - Rules & Competition or his designee. Requests for postponement shall be submitted in writing to the ATP Senior Vice President - Rules & Competition or his designee.
- f) **Record.** Each party shall have the right to have the hearing recorded or transcribed at its expense.
- g) **Interpreter-Legal Advisor.** The ATP Senior Vice President - Rules & Competition or his designee may, at his discretion, make provisions for the presence of an interpreter and/or legal advisor for the hearing. The reasonable expenses of such interpreter or legal advisor shall be assumed by ATP pending the final decision of the ATP Senior Vice President - Rules & Competition or his designee and the taxing of costs as is provided in the decision on appeal.

5) Decision on Appeal

As soon as practicable after the conclusion of the hearing on appeal, the ATP Senior Vice President - Rules & Competition or his designee shall render a written decision, which decision shall constitute the full, final and complete disposition of the issue and will be binding upon the player and upon all members of ATP. The ATP Senior Vice President - Rules & Competition or his designee may vacate, affirm or modify in whole or in part the penalty, but may not increase it. Notwithstanding the foregoing, the ATP Senior Vice President - Rules & Competition or his designee may tax the losing party, whether ATP or the player, all reasonable costs of the Appeal, including, but not limited to, the expenses and charges of the interpreter, legal advisor and any adverse witness required upon objection to testify concerning facts originally presented by way of affidavit. If the costs are taxed against a player, then they must be paid by the player to ATP by delivery to the ATP Fines Committee within (10) days after receipt of the decision of the ATP Senior Vice President - Rules & Competition or his designee.

C. Suspensions and Collection of Fines

1) Suspension - Weeks/Scope

Whenever any suspension is involved as a penalty for a violation of the Code, only weeks with ATP Tour or ATP Challenger Tour tournaments shall be included in the suspension period.

2) Stay of Suspensions Pending Appeal

Whenever a player is suspended by ATP and an appeal either of right or discretionary review is filed, then the suspension shall be stayed pending the resolution of the appeal.

3) Suspension for Non-Payment of Fines

VIII. THE CODE

If a fine is not paid in a timely fashion, ATP may suspend, pending payment, the party fined from further participation in any ATP Tour and ATP Challenger Tour tournament. In addition, ATP is authorized to collect all overdue fines along with costs, if any, by all reasonable means, including deduction of the fine from any subsequent winnings, or through legal proceedings. When a fine is deducted from prize money being paid in non-U.S. currency, the official ATP exchange rate shall be applicable to the payment of the fine, to the extent deducted.

8.06 Tennis Anti-Corruption Program (“TACP”)

Complete rules of the TACP can be found at <https://www.itia.tennis/tacp/rules>.

8.07 Final Dispute Resolution

- A. Any dispute between or among ATP, its Tournaments or its players (with the exception of any dispute relating to or arising out of a change in tournament class membership status) arising out of the application of any provision of this Rulebook which is not finally resolved by applicable provisions of the Rulebook shall be submitted exclusively to the Court of Arbitration for Sport (“CAS”) for final and binding arbitration in accordance with CAS’s Code of Sports-Related Arbitration. The decision of CAS in that arbitration shall be final, non-reviewable, non-appealable and enforceable. No claim, arbitration, lawsuit or litigation concerning the dispute shall be brought in any other court or tribunal. Any request for CAS arbitration shall be filed with CAS within 21 days of any action by ATP which is the subject of the dispute.
- B. In the event any provision of this rule is determined invalid or unenforceable, the remaining provisions shall not be affected. This rule shall not fail because any part of the rule is held invalid.

VIII. THE CODE

IX. PEPPERSTONE ATP RANKINGS

9.01 Definitions

- A.** The 2023 Pepperstone ATP Doubles Team Rankings is the mathematical method of ranking men's doubles pairs on a calendar-year basis.
- B.** The Pepperstone ATP Rankings and the Pepperstone ATP Doubles Rankings are the objective merit-based method used for determining qualification for entry and seeding in all tournaments for both singles and doubles.
- C.** The Pepperstone ATP Rankings and Pepperstone ATP Doubles Rankings are run approximately 45 times per year.
- D.** Every player who has earned Pepperstone ATP Rankings points or Pepperstone ATP Doubles Rankings points in an eligible professional tournament during the entry ranking period is included in the Pepperstone ATP Rankings or Pepperstone ATP Doubles Rankings.
- E.** The Pepperstone ATP Rankings or Pepperstone ATP Doubles Rankings period is the immediate past 52 weeks, except for:
 - * Nitto ATP Finals, singles and doubles, which is dropped on the Monday following the last ATP Tour event of the following year.
 - * ITF tournaments that are only entered into the system on the second Monday following the tournament's week.Once entered, all tournaments, except for the Nitto ATP Finals, remain in the system for 52 consecutive weeks.

9.02 Eligibility

Unless otherwise approved by ATP, Pepperstone ATP Rankings and Pepperstone ATP Doubles Rankings points are awarded to all tournaments or series of tournaments that meet the following criteria. (An event seeking an exception must petition ATP in writing at least 90 days in advance of the tournament.):

- A.** Events classified as ATP Tour and ATP Challenger Tour events. Also, Grand Slam, ITF M 25+H, ITF M 25, ITF M 15+H and ITF M 15 events.
- B.** Prize money must be paid in a manner consistent with the breakdowns approved by ATP.
- C.** Selection of direct acceptances shall be determined according to the Pepperstone ATP Rankings or Pepperstone ATP Doubles Rankings. The Pepperstone ATP Rankings and Pepperstone ATP Doubles Rankings lists utilized shall not be more than 42 days prior to the start of the tournament.
- D.** The minimum size for a draw is 28 singles players and 16 doubles teams unless otherwise approved by ATP.
- E.** The composition of the draws shall be consistent with ATP rules. Tournaments are required to provide hotel accommodation consistent with ATP rules.

IX. PEPPERSTONE ATP RANKINGS

9.03 Pepperstone ATP Rankings

A. Commitment Players. The year-end Pepperstone ATP Rankings is based on calculating, for each player, his total points from the four (4) Grand Slams, the eight (8) mandatory ATP Tour Masters 1000 tournaments and the Nitto ATP Finals of the ranking period, the United Cup and his best seven (7) results from the United Cup, all ATP Tour 500, ATP Tour 250, ATP Challenger Tour and ITF Men's WTT tournaments. For every Grand Slam, mandatory ATP Tour Masters 1000 tournament or United Cup for which a player is not in the main draw, and was not (and, in the case of a Grand Slam, would not have been, had he and all other players entered) a main draw direct acceptance on the original acceptance list, and never became a main draw direct acceptance, the number of his results from all other eligible tournaments in the ranking period, that count for his ranking, is increased by one (1). In weeks where there are not four (4) Grand Slams and eight (8) ATP Tour Masters 1000 tournaments in the ranking period, the number of a player's best results from all eligible tournaments in the ranking period will be adjusted accordingly. Once a player is accepted in the main draw of one of these twelve (12) tournaments, as a direct acceptance, a qualifier, a special exempt or a lucky loser, or having accepted a wild card, his result in this tournament shall count for his ranking, whether or not he participates.* In a 52-week period, players shall be permitted to replace up to 3 mandatory ATP Tour Masters 1000 singles main draw results with a better score from an ATP Tour 500 or ATP Tour 250 event, when the replacing score is achieved after the ATP Tour Masters 1000 score that is being replaced. Notwithstanding the foregoing sentence, the player must have competed and not received a ranking penalty at the ATP Tour Masters 1000 tournament to replace the score.

B. Non-commitment Players. The Pepperstone ATP Rankings is based on calculating, for each player, his total points from the four (4) Grand Slams, the eight (8) mandatory ATP Tour Masters 1000 tournaments and the Nitto ATP Finals of the ranking period, and his best seven (7) results from the United Cup, all ATP Tour 500, ATP Tour 250, ATP Challenger Tour and ITF Men's WTT tournaments. For every Grand Slam or mandatory ATP Tour Masters 1000 tournament for which a player is not in the main draw, and was not (and, in the case of a Grand Slam, would not have been, had he and all other players entered) a main draw direct acceptance on the original acceptance list, and never became a main draw direct acceptance, the number of his results from all other eligible tournaments in the ranking period, that count for his ranking, is increased by one (1). In weeks where there are not four (4) Grand Slams and eight (8) ATP Tour Masters 1000 tournaments in the ranking period, the number of a player's best results from all eligible tournaments in the ranking period will be adjusted accordingly. Once a player is accepted in the main draw of one of these twelve (12) tournaments, as a direct acceptance, a qualifier, a special exempt or a lucky loser, or having accepted a wild card, his result in this tournament shall count for his ranking, whether or not he participates. In a 52-week period, players shall be permitted to replace up to 3 mandatory ATP Tour Masters 1000 singles main draw results with a better score from an ATP Tour 500 or ATP Tour 250 event, when the replacing score is achieved after the ATP Tour Masters 1000 score that is being replaced. Notwithstanding the foregoing sentence, the player must have competed and not received a ranking penalty at the ATP Tour Masters 1000 tournament to replace the score.*

C. ATP Tour 500 – Ranking Penalty. A player's (Commitment and Non-Commitment players) withdrawal from an ATP Tour 500 event whether on time or after the 10 AM

IX. PEPPERSTONE ATP RANKINGS

deadline, shall result in a zero (0) point ranking penalty. Further non-consecutive withdrawals shall result in a zero (0) point ranking penalty assessed for each additional withdrawal. Players with multiple consecutive withdrawals who are out of competition for 30 days or longer due to injury will not be subject to a ranking penalty as long as verified and approved medical forms are provided; or, a player shall not have the ranking penalty imposed if he completes the Promotional Activities requirement as specified under "Repeal of Withdrawal Fines and/or Penalties" or if the on-site withdrawal procedures apply. Players may also appeal withdrawal penalties to a Tribunal who will determine whether the penalties are affirmed or set aside.* A commitment player who has received a zero (0) point ranking penalty for withdrawing from an ATP Tour 500 event may replace the zero (0) point by playing an additional ATP Tour 500 event in that same calendar year for a total of four (4) played. The replacement tournament must be after the 500 withdrawal that has resulted in a ranking penalty. Only one (1) additional ATP Tour 500 event per year may be used to replace an ATP Tour 500 ranking penalty.

* **Note 1:** Commitment players who are unable to fulfill their commitment, are not eligible to appeal the ranking penalty.

Note 2: (Applicable for **9.03 A. B. C.**). Players returning to competition with an Entry Protection Ranking may replace ranking penalties assessed during the period of injury with results obtained at tournaments following their return to competition.

D. Loser points for the rounds achieved are awarded to players in any tournament not completed.

E. Ties. When two or more players have the same total number of points, ties shall be broken as follows:

- 1) the most total points from the Grand Slams, ATP Tour Masters 1000 mandatory tournaments and Nitto ATP Finals main draws, and if still tied, then,
- 2) the fewest events played, counting all missed Grand Slams, ATP Tour Masters 1000 tournaments they could have played (as described under A. above) as if played, and if still tied, then,
- 3) the highest number of points from one single tournament, then, if needed, the second highest, and so on.

F. Entry Protection

1) Petition. A player may petition the ATP CEO, or his designee, for an entry protection when he is physically injured or has a documented medical illness and does not compete in any tennis event, including Special Events – Exhibitions, for a minimum period of six (6) months. The written petition must be received within six (6) months after his last tournament and must provide medical documentation including a letter from a treating licensed physician confirming the injury or illness. Each petition shall be evaluated on a case by case basis by the ATP Medical Services Committee.

2) Calculation and Use. The entry protection shall be a position in the Pepperstone ATP Rankings, as determined by the player's average Pepperstone ATP Rankings position during the first three (3) months* after his last event played. The entry protection shall be for entry into the main draw or qualifying competition or for special exempt consideration. The entry protection shall not be used for seeding

IX. PEPPERSTONE ATP RANKINGS

purposes or lucky loser consideration.

*The player must be ranked (have at least one singles ranking point for a singles protected ranking and/or one doubles ranking point for a doubles protected ranking) during each week of this three (3) month period.

A player who has been out of competition and is applying for Entry Protection may not include any period of (Doping, Corruption and/or Conduct) suspension in the player's weeks away from competition in order to qualify for Entry Protection.

3) Limit of Use.

a) If a player is physically injured and does not compete in any tennis event for a period of at least six (6) months but less than twelve (12) months, the entry protection shall be in effect for the first nine (9) singles and the first nine (9) doubles tournaments that the player competes* in using the entry protection (excluding wild cards and entries as a direct acceptance with his current position in the Pepperstone ATP Rankings) or for the period up to nine (9) months beginning with the first tennis event, including Special Events – Exhibitions, that the player competes in, whichever occurs first.

b) If a player is physically injured and does not compete in any tennis event for a period of twelve (12) months or longer, the entry protection shall be in effect for the first twelve (12) singles tournaments and the first twelve (12) doubles tournaments that the player competes* in using the entry protection (excluding wild cards and entries as a direct acceptance with his current position in the Pepperstone ATP Rankings) or for the period up to twelve (12) months beginning with the first tennis event, including Special Events – Exhibitions, that the player competes in, whichever occurs first.

*Note: For purposes of this rule, once the player is included in the draw or accepts prize money as an on-site withdrawal, the event shall count against the players' total as specified under a) and b) above. The United Cup shall not count against a player's total protected ranking allowance.

c) The use of a protected ranking to enter the singles and/or doubles of a Grand Slam event is limited to once per Grand Slam event.

d) The use of a protected ranking to enter the singles and/or doubles of the United Cup is limited to one (1) per the duration of the player's Protected Ranking.

4) **Expiration Date.** A player has three (3) years from his original last event played to activate his protected ranking and will not be eligible to use his entry protected ranking beyond this date. A player who does not compete in any tennis event, including Special Events – Exhibitions, for a period of three (3) years from the date of his original last event played will have his entry protection revoked.

5) **Re-injury Protection.** A player who has returned to competition and re-injures himself may petition for a "freeze" of the nine (9) or twelve (12) month limit for competing using his protected ranking. To be eligible for the "freeze" the player must be out of competition for a minimum of three (3) months, the written petition for the "freeze" must be received within this period. Upon the player's return to competition he shall have the same number of events and weeks remaining as were available when the "freeze" went into effect. A maximum of two (2) "freezes" are allowed during the nine (9) or twelve (12) month period.

Note: For purposes of this rule, three (3) months is calculated at thirteen (13) weeks; six (6) months is calculated at twenty-six (26) weeks; nine (9) months is calculated at thirty-nine (39) weeks; and twelve (12) months is calculated at

IX. PEPPERSTONE ATP RANKINGS

fifty-two (52) weeks.

Case: A player requests an entry protection freeze after the three (3) year expiration has passed; however, his last event played is before the three (3) year expiration date. Can the player "freeze" his protected ranking?

Decision: A player cannot request a "freeze" after the three (3) year expiration has passed.

Case: A player returns to competition following a "freeze", the number of weeks remaining from the freeze extend beyond the three (3) year expiration date. Can the player use all remaining weeks past the three (3) year expiration date?

Decision: A player cannot extend the use of his entry protected ranking beyond the three (3) year expiration date.

Case: A player accepted in an ATP Tour, ATP Challenger Tour main draw or ATP Tour/Challenger Qualifying list using a PR, withdraws prior to the withdrawal deadline and accepts a WC into the same event. Does this tournament count towards the total tournaments at which a player may use his PR?

Decision: No, this tournament will not count towards the player's total of tournaments.

G. Points.

- 1) Points shall be allocated based on tournament category (Grand Slam, Nitto ATP Finals, ATP Tour Masters 1000, ATP Tour 500, ATP Tour 250, ATP Challenger Tour and ITF Men's WTT events).
- 2) Points are assigned to the losers of the round indicated. Any player who reaches the second round by drawing a bye and then loses shall be considered to have lost in the first round and shall receive first round loser's points. Wild cards at Grand Slams and ATP Tour Masters 1000 events receive points only from the 2nd round. No points are awarded for a first round loss at ATP Tour 500 & 250 events, ATP Challenger Tour or ITF Men's WTT events.
- 3) Players qualifying for the main draw through the qualifying competition shall receive qualifying points in addition to any points earned, as per the following table, with the exception of ITF Men's WTT events.
- 4) In addition to the points allocated as per the following table, points shall be allocated to losers at Grand Slam, ATP Tour Masters 1000, ATP Tour 500 and ATP Tour 250 tournaments qualifying events, as follows:

Grand Slams	16 points for a last round loss 8 points for a second round loss
ATP Tour Masters 1000	16 points for a last round loss (*) 0 points for a first round loss
ATP Tour 500	10 points for a last round loss (**) 0 points for a first round loss
ATP Tour 250	6 points for a last round loss (***)

IX. PEPPERSTONE ATP RANKINGS

0 points for a first round loss

* 8 points only if the main draw is larger than 56

** 4 points only if the main draw is larger than 32

*** 3 Points only if the main draw is larger than 32

5) Point table.	W	E	SF	QF	R16	R32	R64	R128	Q	Q3	Q2
Grand Slams	2000	1200	720	360	180	90	45	10	25	16	8
Nitto ATP Finals*	1500										
ATP 1000 - 96 Draw	1000	600	360	180	90	45	25	10	16		8
ATP 1000 - 48/56 Draw	1000	600	360	180	90	45	10		25		16
United Cup**	500										
ATP Tour 500 - 48 Draw***	500	300	180	90	45	20			10		4
ATP Tour 500 - 32 Draw***	500	300	180	90	45				20		10
ATP Tour 250 - 48 Draw	250	150	90	45	20	10			5		3
ATP Tour 250 - 32 Draw	250	150	90	45	20				12		6
Challenger 175	175	100	60	32	15				6		3
Challenger 125	125	75	45	25	11				5		2
Challenger 100	100	60	36	20	9				5		2
Challenger 75	75	50	30	16	7				4		2
Challenger 50	50	30	17	9	4				3		1
ITF M 25/25+H ****	25	16	8	3	1						
ITF M 15/15+H ****	15	8	4	2	1						

* Nitto ATP Finals 1,500 for undefeated Champion (200 for each round robin match win, plus 400 for a semi-final win, plus 500 for the final win)

** For details, see Section 4.03 G.

*** The doubles qualifying team shall receive 45 ranking points. The team losing in the final round of qualifying shall receive 25 ranking points.

Teams receiving a first round Bye and subsequently losing in the final round receive no points.

**** Pepperstone ATP Doubles Rankings points will be awarded in ITF M 25/25+H and ITF 15/15+H tournaments beginning with the quarter-final round.

9.04 Pepperstone ATP Doubles Rankings

A. The Pepperstone ATP Doubles Rankings is based on calculating, for each player, his total points from his best 19 results from all eligible tournaments, including the Nitto ATP Finals (Doubles) played in the Ranking period. For entry purposes there are no mandatory events, however, once a player is included in the main draw of any of the four (4) Grand Slams or the eight (8) ATP Tour Masters 1000, as a direct acceptance, a qualifier, alternate or a lucky loser or having accepted a wild card, his result in one of these twelve (12) tournaments, shall count for his ranking, whether or not he participates. The exception to this is once per player per calendar year, a player whose

IX. PEPPERSTONE ATP RANKINGS

team is forced to withdraw after the draw has been made but prior to the team's first match shall not have the withdrawal count as a tournament played for purposes of ranking.

B. Loser points for the rounds achieved are awarded to players in any tournament not completed.

C. Ties. When two or more players have the same total number of points, ties shall be broken as follows:

- 1) the fewest events played*, and if still tied, then,
- 2) the most total points from the Grand Slams, ATP Tour Masters 1000 mandatory tournaments and the Nitto ATP Finals (Doubles), and if still tied, then
- 3) the highest number of points from one single tournament, then, if needed, the second highest, etc.

*Once a team is included in the main draw of a Grand Slam or one of the eight (8) ATP Tour Masters 1000 it shall count as an event played whether or not the team actually participated.

Note: The method for breaking ties on-site, between teams, is described under Selections of Entries.

D. **Entry Protection.** The Entry Protection, as described above for the Pepperstone ATP Rankings, applies for doubles under the same provisions.

E. **Points.** The provisions set forth under 9.03.E.1), 2) and 3) related to the Pepperstone ATP Rankings apply to doubles as well, the point table being similar, except that the second-round loser column becomes irrelevant. No points are awarded in the first round at any event.

Doubles - After First Round:

Should a doubles match in an ATP Tour or ATP Challenger Tour event be untested or fail to be completed, the losing team shall only receive points and prize money from the previous round unless one of the following exceptions is applicable:

- a) Neither player was in the singles main draw;
- b) Both players used, or could have used**, their doubles ranking for entry into the doubles draw (does not apply to wild card teams).
- c) The retiring/withdrawing player is still in the singles competition and at the time of the medical examination is declared unfit to play in the singles of that event or, if no longer involved in the singles competition of that event, is forced to withdraw from the singles or doubles*** of the next tournament in which he is entered.
 - i) For ATP Tour events if the retiring/withdrawing player was not in the singles draw of that event and is forced to withdraw from the next event in which he is accepted in the main draw (singles or doubles).
 - ii) For ATP Challenger events if the retiring/withdrawing player was not in the singles draw of that event and is forced to withdraw from the following week's event (single or doubles) after the withdrawal deadline.
- d) The retiring/withdrawing player was not involved in the singles draw of that event and:

IX. PEPPERSTONE ATP RANKINGS

- i) For ATP Tour events is forced to withdraw from the next event in which he is entered (singles or doubles).
 - ii) For ATP Challenger events is forced to withdraw from the following week's event (singles or doubles***).
- e) The retiring/withdrawing player had withdrawn/retired from his singles match, which was scheduled the same day; or, if the doubles match is scheduled for a following day the player is examined by the tournament Doctor and is declared unfit for competition in the doubles event.

** Example: Player A is not in the singles draw and his doubles ranking is 20; his partner, Player B, is in the singles draw with a ranking of 15. Player B's doubles ranking is 30. The cutoff for their method of entry is 60. Using player B's doubles ranking would have kept them as a direct acceptance so they qualify for exception b) above.

*** For ATP Challenger events the withdrawal for doubles must be after the withdrawal deadline.

Case: *Player A retires / withdraws from the doubles for medical reasons. Player A is also in the singles draw but is not scheduled to play his next match until the next day. On the day of his scheduled singles match Player A withdraws from the singles and receives medical documentation from the Tournament Doctor declaring him unfit for competition. The medical condition is the same condition that caused the doubles retirement / withdrawal.*

Decision: *In this case the doubles team shall receive points / prize money from the round reached.*

Case: *Player A retires from the singles competition due to a medical issue. He is in the doubles competition but is not scheduled to play doubles that day. Player A is examined by the tournament Doctor who confirms that the medical issue is such that the player would not be able to compete in the doubles that week. May Player A's withdrawal and medical be accepted even though he is not scheduled to play doubles that day?*

Decision: *If the medical issue is such that the tournament Doctor can confirm the player's condition will not improve enough to compete in the doubles that week then the player may withdraw immediately and the medical is valid. Player A and his partner shall be eligible to receive ranking points and prize money from the round reached.*

Case: *Player A withdraws from the singles competition due to food poisoning, he is in the doubles competition but is not scheduled to play doubles until the next day. Player A would like to withdraw from the doubles immediately, however the tournament Doctor says he cannot declare him unfit for play for a match scheduled the following day.*

Decision: *If Player A withdraws from the doubles without a medical from the tournament Doctor declaring him unfit for play then the team receives ranking points / prize money from the previous round.*

Note: *In cases where the condition of the player is likely to improve in a short time period the tournament Doctor should examine the*

IX. PEPPERSTONE ATP RANKINGS

player on the day of the match to determine his status and if he feels the player is fit for competition.

9.05 2023 Pepperstone ATP Doubles Team Rankings

A. Each team is ranked according to its total points from its best 19 results from all eligible tournaments (Grand Slam, ATP Tour, including the Nitto ATP Finals, ATP Challenger Tour, ITF Men's WTT) played in the calendar year.

B. Loser points for the rounds achieved are awarded to players in any tournament not completed.

C. Ties. Ties between two or more teams having the same total number of points shall be broken using the same methods as for breaking ties between players in the Pepperstone ATP Doubles Rankings.

D. Points. The provisions set forth under 7.08 E., including a), b) and c), apply as well when calculating the 2023 Pepperstone ATP Doubles Team Rankings.

9.06 Retiring from the Professional Tennis Circuit

Any player wishing to officially retire from the professional tennis circuit must submit a signed Player Retirement Form to the Vice President, Player Relations of ATP. Once the signed form is received the player shall be removed from the Pepperstone ATP Rankings (singles and doubles). The player also agrees to the terms of the Tennis Anti-Doping Program regarding reinstatement protocol.

IX. PEPPERSTONE ATP RANKINGS

X. EXHIBITS

EXHIBIT A.01 - ATP Tour Official Tournament Stamps



EXHIBIT A.02 - Size Relationships - Men Only Events



Size Relationship: Tournament Logo
MUST be a minimum of 60% of the surfaced area of the tournament logo



Size Relationship: Tournament Title
MUST be a minimum of 60% of the surface area of the tournament title

X. EXHIBITS

EXHIBIT A.03 - Size Relationship - Combined Events



Size Relationship: WTA Logo
 MUST be the same visual size (cover the same surface area)



Size Relationship: Tournament Logo
 MUST be at a minimum, equal size to the WTA Logo or 30% of the surface area of the tournament logo, whichever is greater.



Size Relationship: Tournament Title
 MUST be at a minimum, equal size to the WTA Logo or 30% of the surface area of the tournament title, whichever is greater.

X. EXHIBITS

EXHIBIT A.04 - Positioning

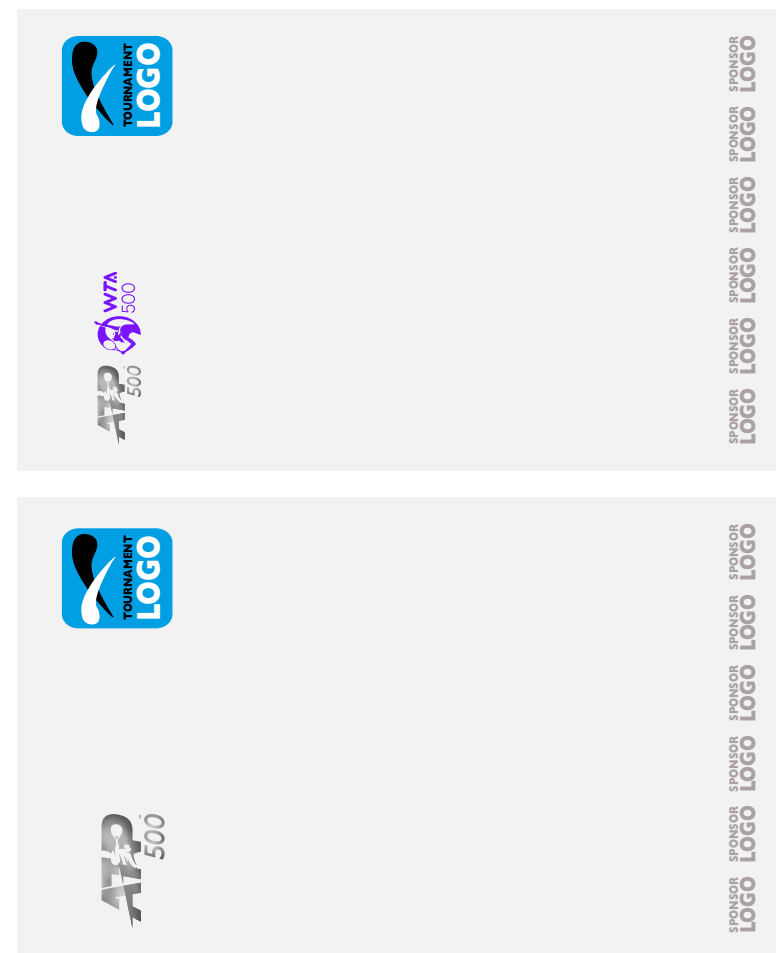

MUST be placed closest to the tournament logo of tournament title, away from sponsor logos. NEVER add to sponsor logo strips

X. EXHIBITS

EXHIBIT A.05 - Exclusion Area

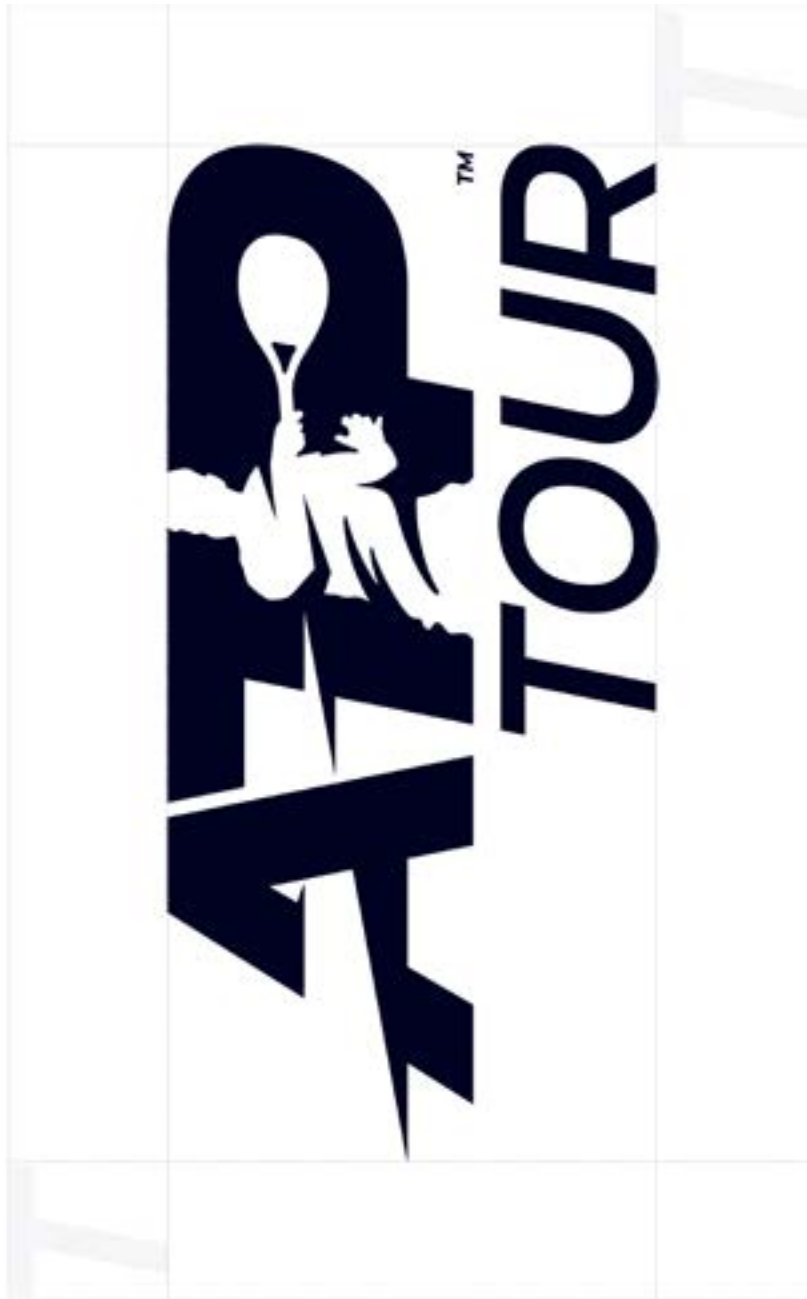

X. EXHIBITS

EXHIBIT A.06.1 - Acceptable & Unacceptable uses - Men Only

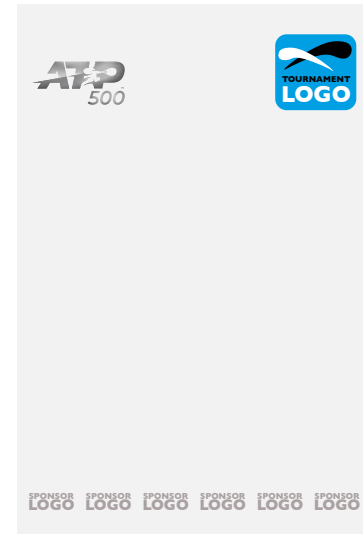

DO

place the ATP Tour Official Tournament Stamp closest to the tournament logo. Ensure it is at least 60% of the surface area of the tournament logo and is positioned away from sponsor logos, federation names or any other brand mark

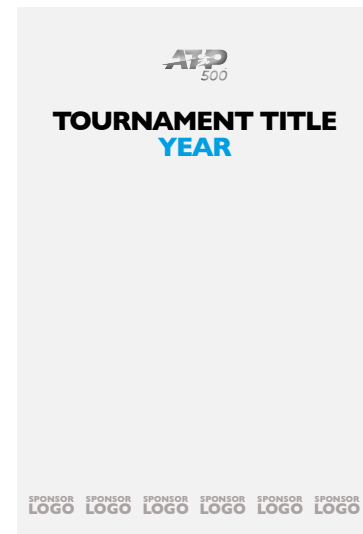

DO

place the ATP Tour Official Tournament Stamp closest to the tournament title when it is used larger than, or in place of the tournament logo. Ensure it is at least 60% of the surface area of the tournament title and is positioned away from the sponsor logos, federation names or any other brand mark.

X. EXHIBITS

EXHIBIT A.06.2 - Acceptable & Unacceptable Uses - Men Only

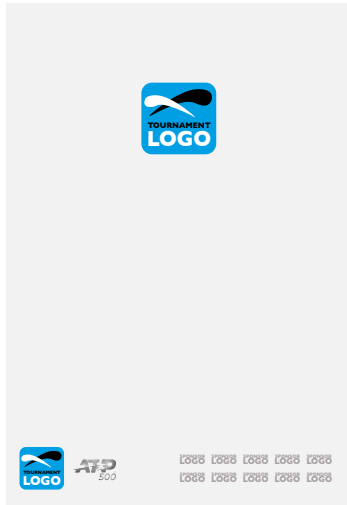

DO NOT
apply rules to the smallest tournament logo or tournament title on this page.

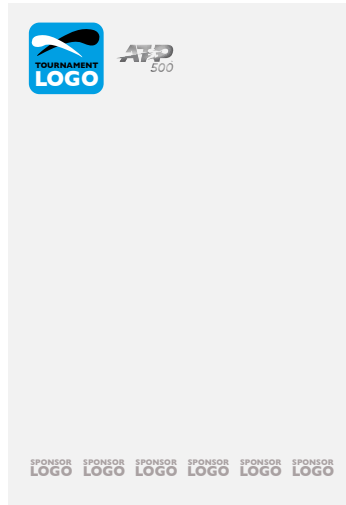

DO NOT
make the ATP Tour Official Tournament Stamp smaller than 60% of the tournament logo or tournament title.

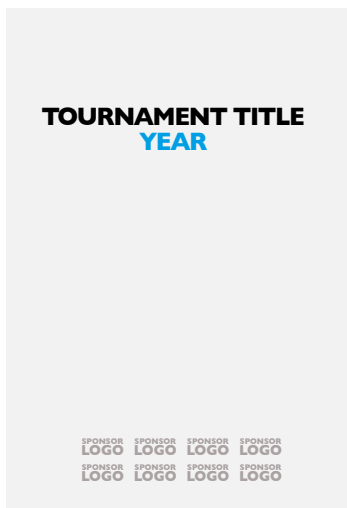

DO NOT
omit the ATP Tour official Tournament Stamp when using a tournament title in place of a tournament logo.

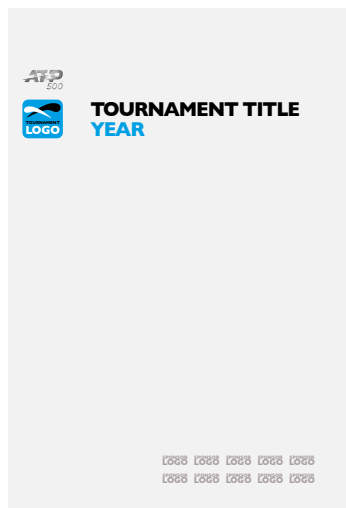

DO NOT
Apply rules to the smallest tournament logo or tournament title when both are used on a page. The 60% applies to the greater of the two.

X. EXHIBITS

EXHIBIT A.06.3 - Acceptable & Unacceptable Uses - Men only

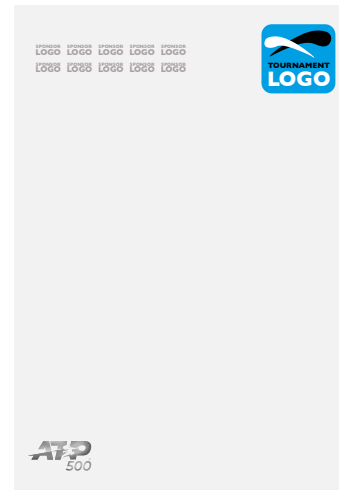

DO NOT
Place sponsor logos closest to the tournament logo or tournament title

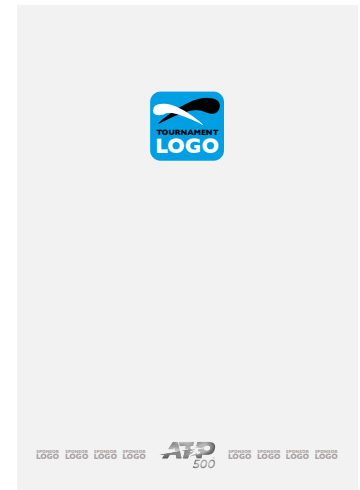

DO NOT
place the ATP Tour Official Tournament Stamp alongside sponsor logos or add it to sponsor logo strips

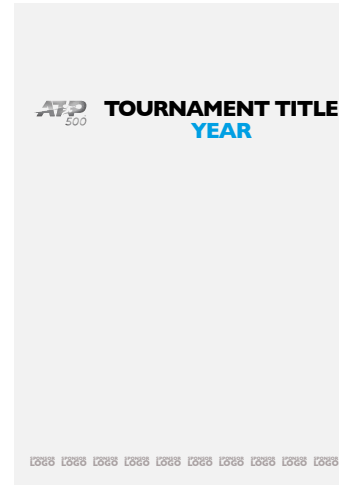

DO NOT
make the ATP Tour Official Tournament Stamp smaller than 60% of the surface area of the tournament logo or tournament title

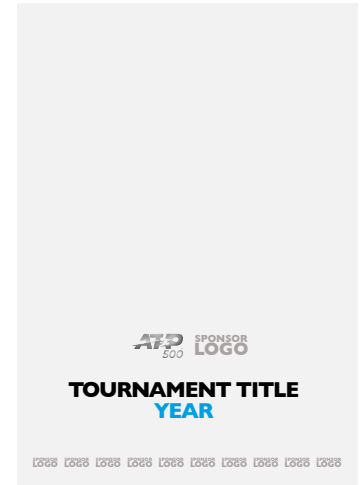

DO NOT
break the exclusion area for sponsor logos

X. EXHIBITS

EXHIBIT A.06.4 Acceptable & Unacceptable Uses - Combined

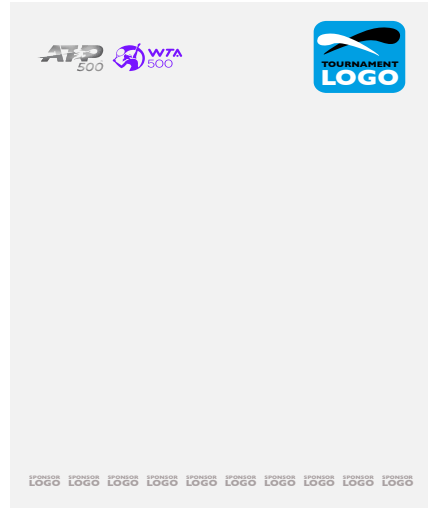

DO

place the ATP Tour Official Tournament Stamp closest to the tournament logo. The ATP Tour Official tournament stamp must be at a minimum, equal size to the WTA logo or 30% of the surface area of the tournament logo, whichever is greater. Position away from sponsor logos, federation names or any other brand mark.

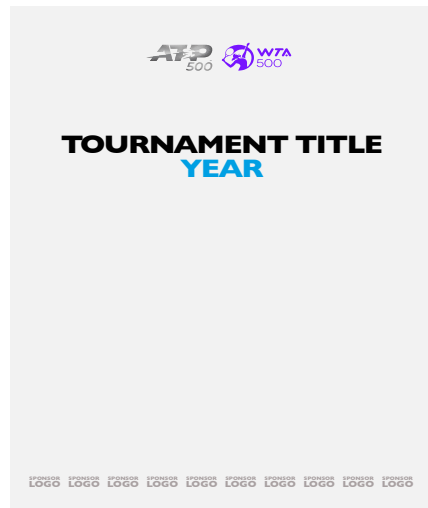

DO

place the ATP Tour Official Tournament Stamp closest to the tournament title when it is used larger than, or in place of, the tournament logo. The ATP Tour Official Tournament Stamp must be at a minimum equal size to the WTA logo or 30% of the surface area of the tournament title, whichever is greater. Position away from sponsor logos, federation names or any other brand mark.

X. EXHIBITS

EXHIBIT A.06.5 Acceptable & Unacceptable Uses - Combined

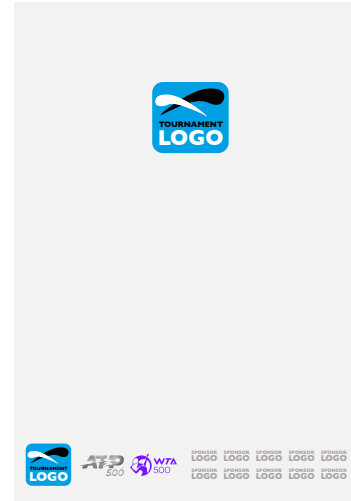

DO NOT

apply rules to the smallest tournament logo or tournament title on the page.

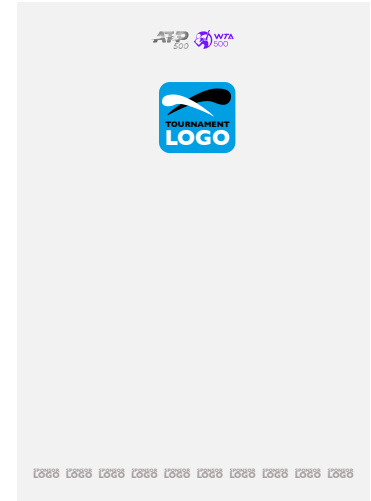

DO NOT

make the ATP Tour Official Tournament Stamp smaller than 30% of the surface area of the tournament logo.

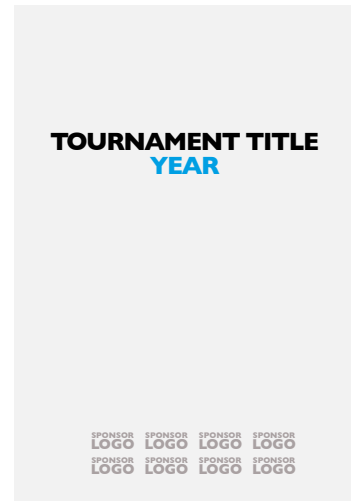

DO NOT

omit the ATP Tour Official Tournament Stamp when using a tournament title in place of a tournament logo.

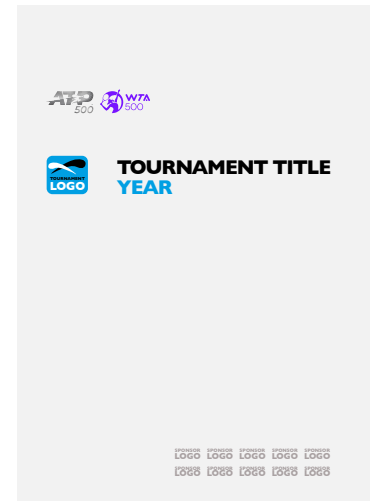

DO NOT

apply rules to smallest tournament logo or tournament title when both are used on the page. 30% rule applies to the greater of the two.

X. EXHIBITS

EXHIBIT A.06.6 - Acceptable & Unacceptable Uses - Combined

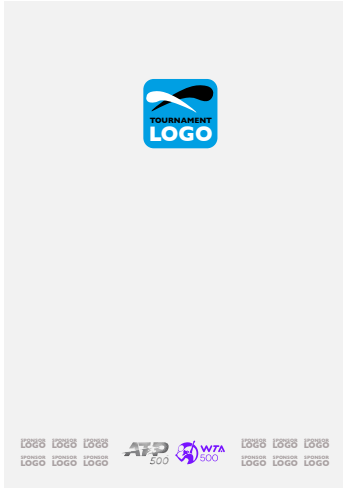

DO NOT
place the ATP Tour Official Tournament Stamp alongside sponsor logos or add it to sponsor logo strips.

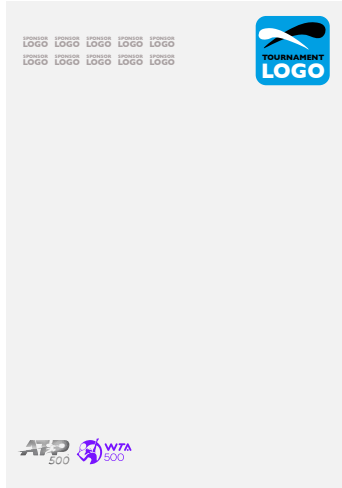

DO NOT
make the WTA Logo visually larger than the ATP Tour Official Tournament Stamp. DO NOT place sponsor logos closer to the tournament logo or tournament title.

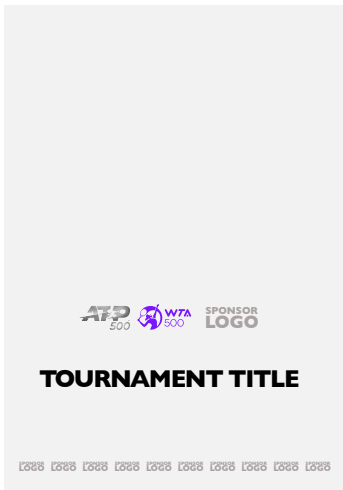

DO NOT
break the exclusion area for sponsor logos.

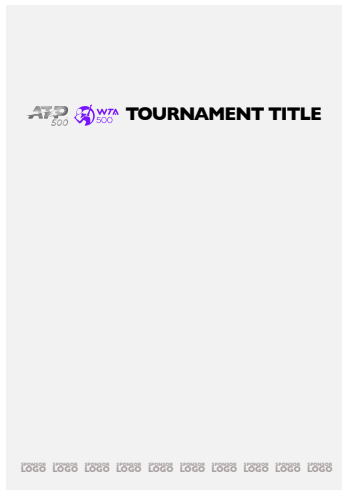

DO NOT
make the size of the ATP Tour Official Tournament Stamp smaller than 30% of the surface area of the tournament logo tournament title.

X. EXHIBITS

EXHIBIT A.07 - Website Exhibit



EXHIBIT A.08 - Scoreboards / Draw Boards



X. EXHIBITS

EXHIBIT A.09 - Electronic Devices



X. EXHIBITS

EXHIBIT A.10 - Nets / Net Signage

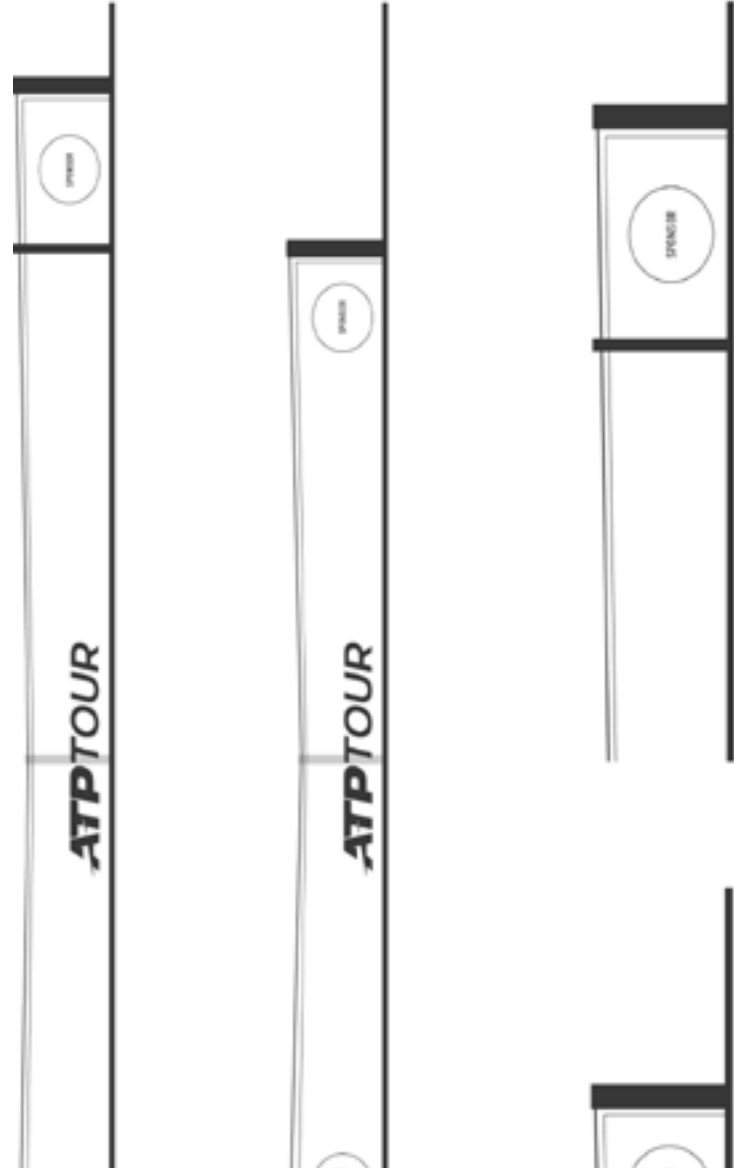

X. EXHIBITS

EXHIBIT A.11 - Media Backdrop



X. EXHIBITS

EXHIBIT A.12 - Court Surface Color

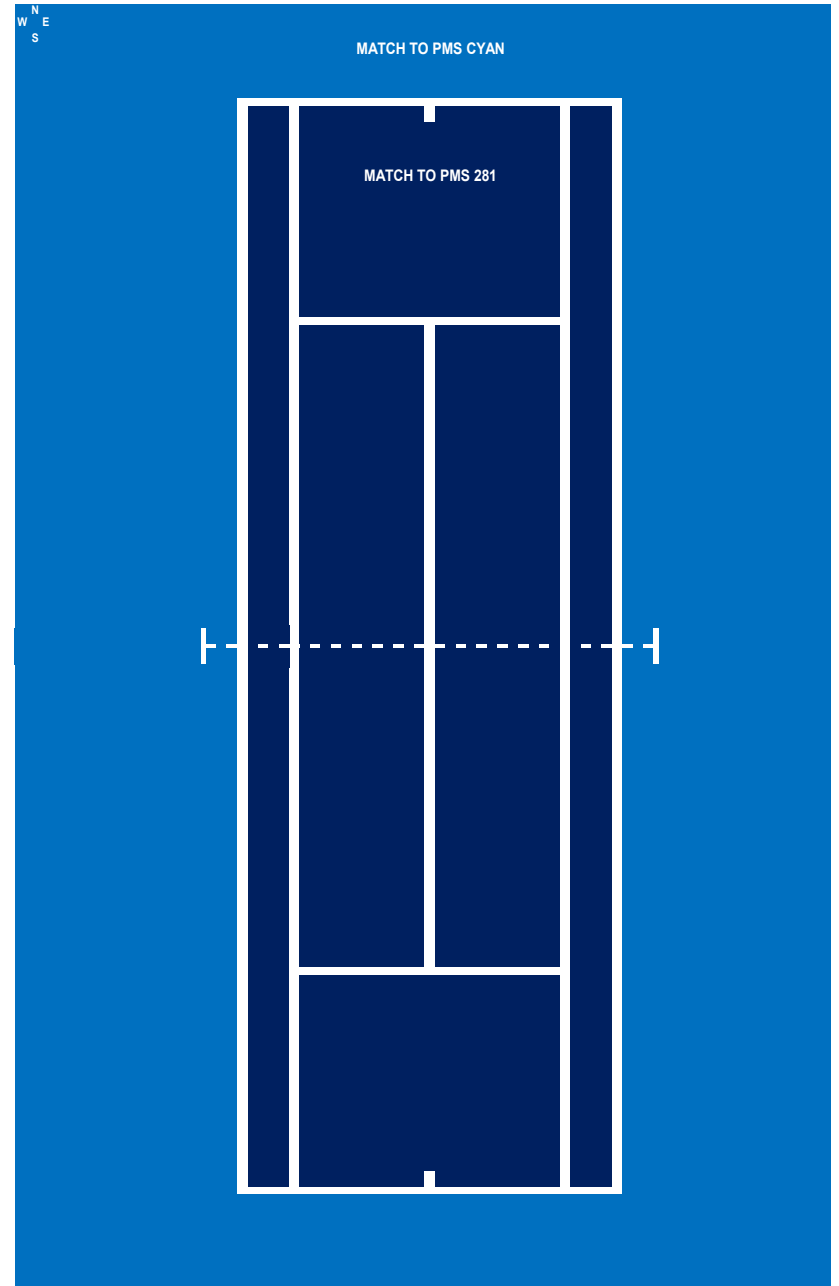

X. EXHIBITS

EXHIBIT A.13.1 - Court Host Locality - Option 1 - Hard Court

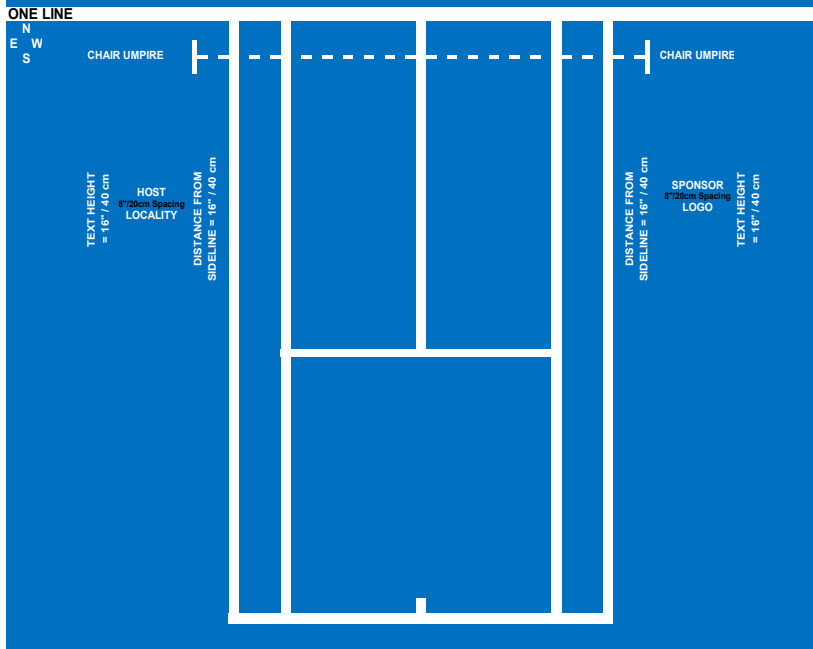
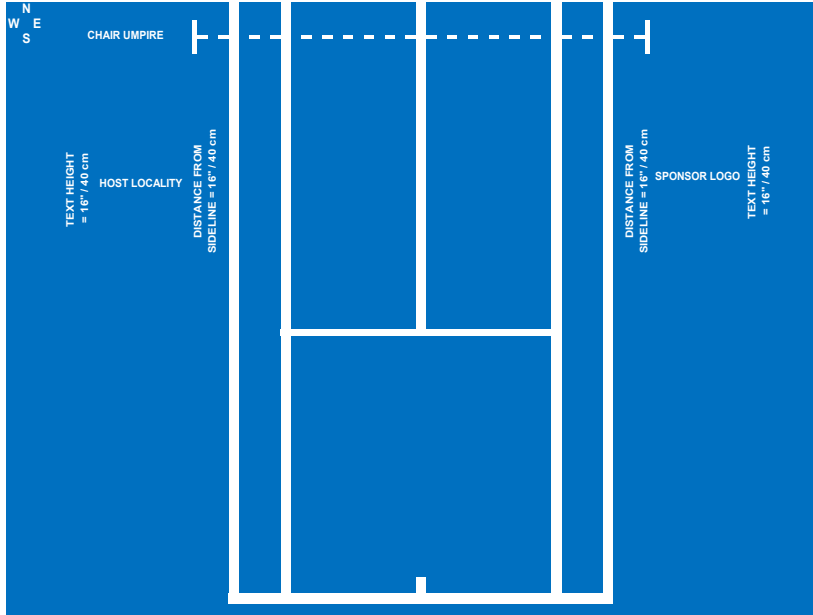

TWO LINES

X. EXHIBITS

EXHIBIT A.13.1 - Court Host Locality - Option 1 - Clay Court

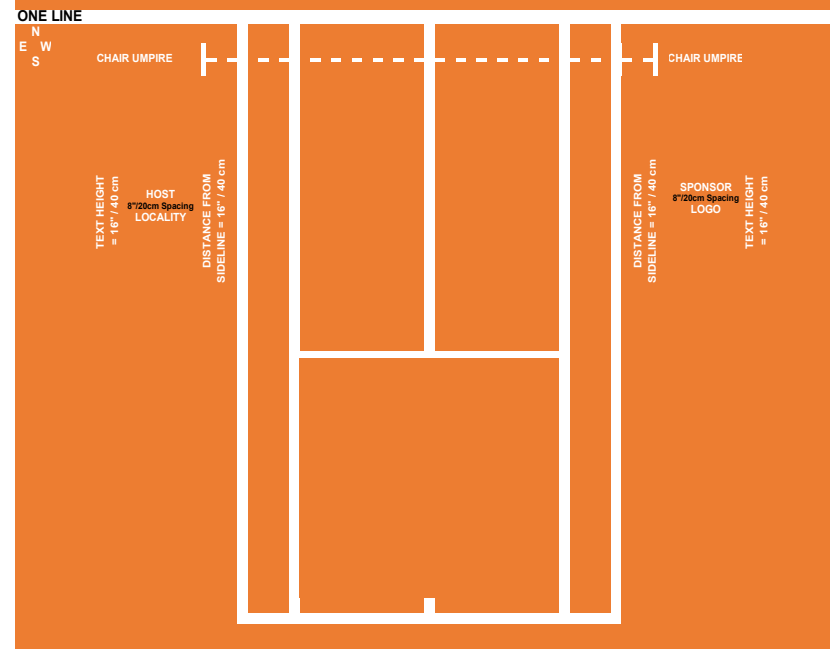
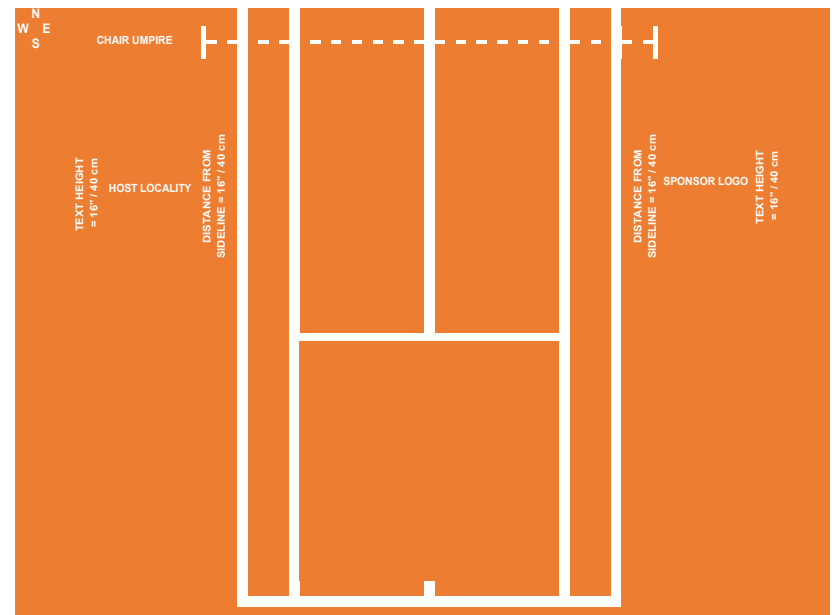

TWO LINES

X. EXHIBITS

EXHIBIT A.13.2 - Court Host Locality - Option 2 - Text

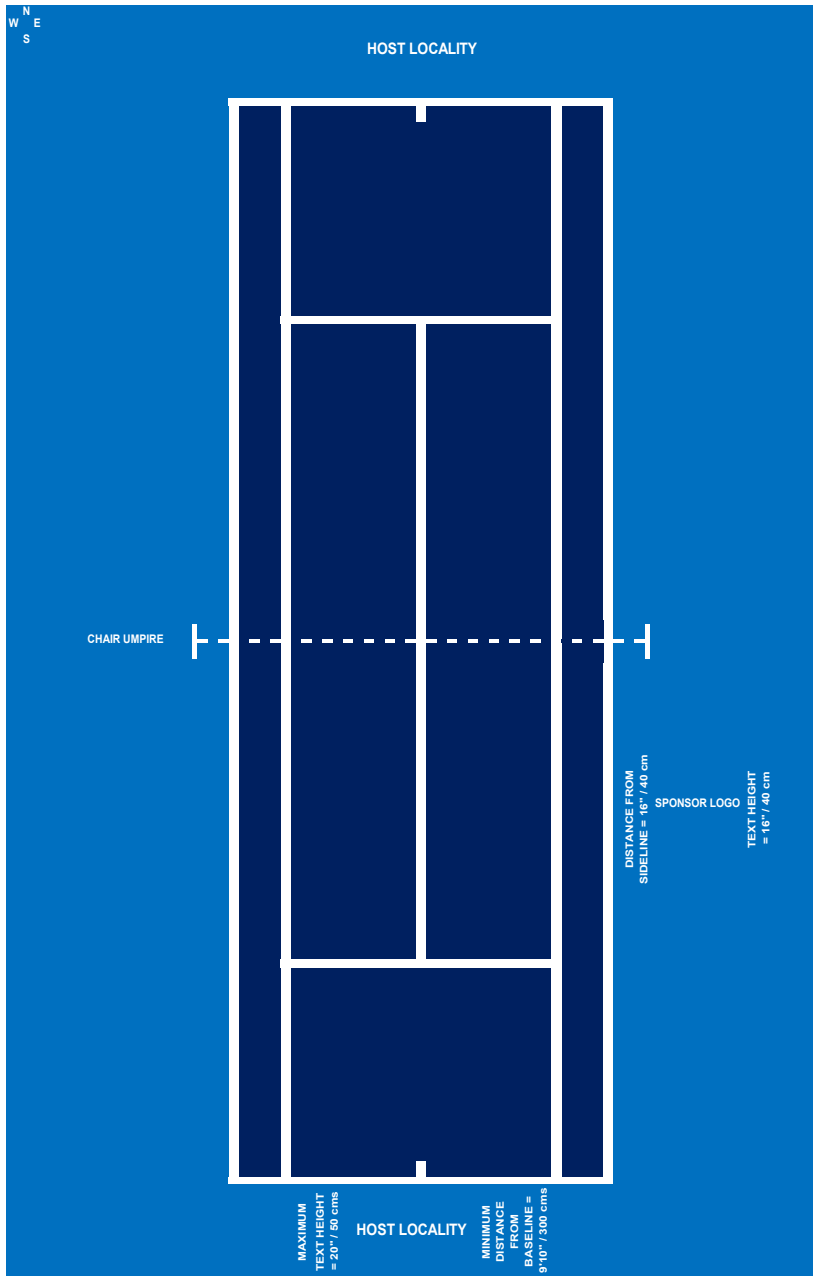

X. EXHIBITS

EXHIBIT A.13.2 - Court Host Locality - Option 2 - Logo

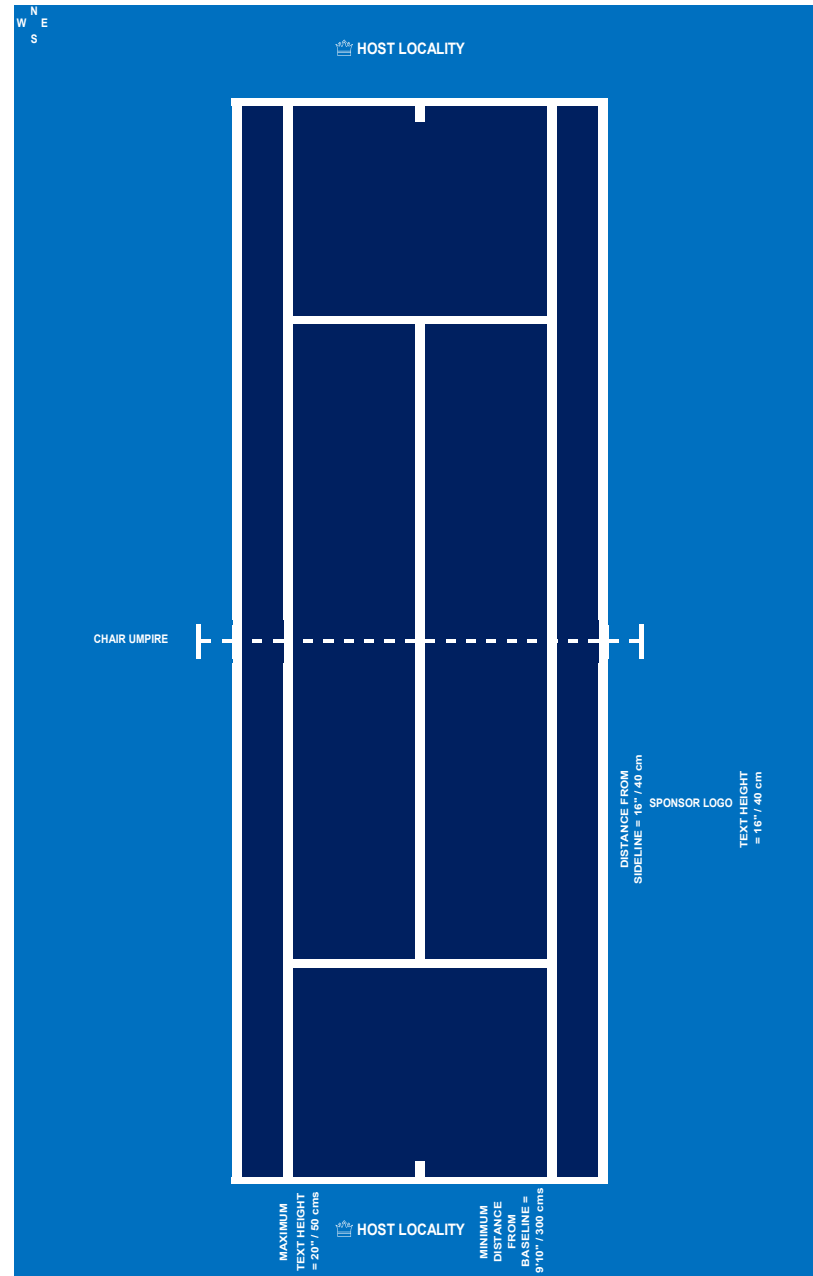

X. EXHIBITS

EXHIBIT A.13.3 - ATP Challenger Tour Court Surface ID

X. EXHIBITS

EXHIBIT A.14 - Court Backdrops



X. EXHIBITS

EXHIBIT A.15 - ATP Challenger Tour Brand Mark



Positive



Negative

EXHIBIT A.16 - ATP Challenger Tour Website



X. EXHIBITS

EXHIBIT A.17. ATP Challenger Tour Court Backdrops



X. EXHIBITS

EXHIBIT B - ATP Tour Logo

ATP Tour Trademark and Logo (Terms and Conditions)

In addition to Exhibit A, the following are the terms and conditions for the use of any ATP Tour trademark or logo (collectively referred to herein as the "ATP Logo"). Only ATP Tour tournaments referred to in CIRCUIT REGULATIONS shall be permitted to use the ATP Logo. ATP Challenger Tour tournaments are authorized to use only the ATP Challenger Tour Brand Mark (collectively referred to herein as the "Challenger Tour Brand Mark") (see "EXHIBIT A.15").

- 1) Each tournament acknowledges that ATP has created the ATP Logo and has used the ATP Logo on and in connection with the promotion of the sport of tennis, recreational facilities, tennis videos, sporting goods, clothing, various printed matter, and other officially licensed products and merchandise, and have sought worldwide trademark registration for same and, through the use of the ATP Logo, ATP has developed goodwill associated with the ATP Logo.
- 2) Subject to the terms and conditions set forth herein, ATP hereby authorizes each tournament, by this license, to use the ATP Logo (and the applicable 1,000, 500 or 250 Tournament Stamp) or Challenger Tour Brand Mark, as applicable, in connection with the advertising and promotion of such tournament. This authorization and license shall (i) in the case of each ATP Tour tournament, be subject to such ATP Tour tournament remaining a member in good standing of ATP as well as compliance with the other terms and conditions set forth herein, and (ii) in the case of each ATP sanctioned tournament or event, including ATP Challenger Tour events, be subject to such tournament maintaining its sanction with ATP in good standing as well as compliance with the other terms and conditions set forth herein. Such license will be limited to written advertising and publicity, such use being for the sole purpose of identifying a tournament as an ATP Tour or Challenger Tour tournament and will not extend to any use that exploits the ATP Logo or Challenger Tour Brand Mark in any other fashion or to the use of the ATP Logo or Challenger Logo on merchandising or products of any kind without the express written approval of ATP.
- 3) Use of the ATP Logo or Challenger Logo by a tournament shall be restricted to the advertising and promotion of such tournament. The use of the ATP Logo must be approved in advance by ATP.
- 4) The use of the ATP Logo or Challenger Tour Brand Mark by a tournament does not extend to use on merchandise or resold products without the express written approval of ATP, unless obtained through an official ATP licensee.
- 5) However, the ATP Logo or Challenger Tour Brand Mark may be used by a tournament to produce and sell tournament T-shirts and sweatshirts (not collared shirts) with the ATP Logo or Challenger Tour Brand Mark not to exceed four (4) square inches (26 sq. cm.). Express written approval is required from ATP if a tournament wants to produce these items itself. No approval is required if the T-shirts and sweatshirts are obtained from an approved ATP licensee.
- 6) Each tournament hereby acknowledges that ATP owns all rights, title and interest in and to the ATP Logo (and the applicable 1,000, 500 or 250 Tournament Stamp) and Challenger Logo and each tournament agrees it will do nothing inconsistent with such ownership nor attack ATP's title or interest in and to the ATP

X. EXHIBITS

Logo or Challenger Tour Brand Mark other than the right to use the ATP Logo or Challenger Tour Brand Mark in accordance with this agreement.

- 7) Each tournament agrees that it will not file a trademark application or otherwise attempt to register the ATP Logo (and the applicable 1,000, 500 or 250 Tournament Stamp) or Challenger Tour Brand Mark, or any trademark or logo that may incorporate the ATP Logo or Challenger Tour Brand Mark, for any goods or services whatsoever. Each tournament shall promptly notify ATP of any infringement of the ATP Logo or Challenger Tour Brand Mark or any act of unfair competition by third parties relating to the ATP Logo or Challenger Tour Brand Mark, whenever such infringement or act shall come to the attention of a tournament.
- 8) Each tournament agrees that all goodwill that is or shall become associated with the ATP Logo or Challenger Tour Brand Mark shall be the sole property of ATP.
- 9) Each tournament agrees to use the ATP Logo or Challenger Tour Brand Mark strictly in compliance with and in observance of any and all applicable laws and strictly in accordance with ATP rules and regulations and guidelines and will take whatever steps are reasonably necessary to fully protect ATP's ownership of the ATP Logo and Challenger Tour Brand Mark, including, without limitation, such legends, markings and notices in connection therewith as may be required by ATP.
- 10) Each tournament agrees that such tennis tournament and related services identified in connection with the ATP Logo and Challenger Tour Brand Mark shall be of the highest quality and shall conform to the high standards and reputation of ATP. Each tournament acknowledges that the provisions of this paragraph are of the essence of this authorization and license.
- 11) If a tournament shall fail to perform or observe any term, condition, agreement, or covenant in this "EXHIBIT B - ATP Tour Logo", ATP shall have the right to automatically terminate this authorization and license forthwith.

X. EXHIBITS

EXHIBIT C - Broadcast Standards

Broadcast Quality Standards

1) Tape Delay/Repeats

Tournaments may not license to domestic or international broadcasters the right to telecast any portion of any match more than 48 hours after the termination of that match, and not more than (3) times within that 48-hour period, unless written authorization is obtained in advance from ATP. Each repeated telecast during the same day must be scheduled in a different part of the day in the same time zone. In the case of any telecast that is not live, tournaments must ensure that broadcasters provide a continuously visible on-screen legend stating "Tape Delay".

The requirement in the above paragraph shall not apply to telecasts under the following situations.

- a) Less than five (5) minutes of continuous action (including time between points) or less than three (3) minutes of match highlights on any news or highlights program.
- b) If because of rain delay or other unavoidable cessation in play, the scheduled broadcast match is canceled, the 48-hour tape delay restriction will be lifted. Any previously recorded match from the current year's competition or last year's competition can be repeated as "filler" programming.

2) Broadcaster's Responsibilities

Each tournament must incorporate the following terms within their Broadcaster contracts.

- a) Host Broadcaster and all International Broadcasters must graphically identify the broadcast with the ATP's logo at the commencement of each broadcast and during the broadcast no less than once an hour, each occurrence lasting no less than five (5) seconds, so as to make clear that the tournament being played is an official ATP event.
- b) Host Broadcaster must supply ATP, or ATP designee with one international dirty HDCam or DigiBeta of the final match or on a Portable Hard Drive with a USB 3.0 or FireWire 800 port (or a Beta SP if no other option). Recordings must be available to the ATP Senior Vice President - Rules & Competition on-site immediately after signing off the air or sent to an ATP office promptly after the tournament.
- c) With respect to any live match scores or related statistical data provided to broadcaster by ATP, or its designee, or collected by broadcaster, such broadcasters shall agree (i) not to onward supply, sublicense or otherwise make such scores and data available to any third party for use not related to the broadcast, and (ii) to restrict their use of such scores and data to use on a contemporaneous basis within their live broadcast of any match; any other use shall be subject to a delay of at least :30 seconds.
- d) All tournament agreements with Host Broadcasters must comply with, and shall be subject to, all ATP rules as amended from time to time.

3) Technical Requirements

Each tournament must incorporate the following technical terms within their Host Broadcaster contract. These conditions represent the minimum technical standards necessary to produce a quality broadcast.

X. EXHIBITS

Cameras

No less than five (5) cameras must be used on Center court (and no less than three (3) cameras on other courts)) for an acceptable tennis broadcast.

Camera 1: Tripod camera high up in the stands (Center Court line).

Camera 2: Tripod camera approximately three (3) rows lower than Camera 1 (Center Court line). (Example 1)

Cameras 3 and 4: Camera objective lens height approximately 1.00m (see attached charts for camera positions). Used for player close-ups for cutting into coverage and isos.

These cameras may be positioned on the same or opposite side from where the players sit down.

Camera 5: Low angle camera on court behind the baseline usually aligned with sideline (see attached chart, Camera Example 2)

Note: Cameras 1, 2, 3, and 4 need to be on secure tripods with fully rotating camera mounts, and remotely controlled irises.

Lenses

Lenses for Camera 1 should be 18:1. Lenses for Cameras 2, 3, and 4 should be 50:1.

Microphones

- 1) Four (4) corner court microphones must be positioned in the corners of the court and adjacent to Cameras 3 and 4.
- 2) At least one (1) microphone must be placed for purposes of picking up sound from the crowd.
- 3) One (1) microphone must be placed on the umpire's chair.

Center Court Masters 1000 Tournaments: ATP Masters 1000 tournament shall provide a fully cabled site and infrastructure for aerial camera system on center court.

Television Regulation Regarding Same Day Exclusivity

No tournament Class member shall be permitted to telecast or grant any telecaster the right to telecast, in any country in the territory of Europe, all or any portion of any tennis match on the same day as a tennis match from any ATP event that is being telecast in such country by a telecaster to which ATP has granted telecast rights, unless (x) such tournament Class member (i) is obligated to grant such rights pursuant to a binding agreement entered into prior to September 4, 1994, and furnished to the General Counsel of ATP pursuant to the ATP Board's resolution of September 4, 1994, or (ii) has received the written permission of the ATP CEO, or (y) the telecast right granted by the tournament Class member is to a host broadcaster whose television signal is carried only in the country in which that member's tournament is conducted, subject to such reasonable "spillage" into other countries as may be approved by the ATP CEO; provided, however, that the foregoing shall not limit the right of any tournament Class member to permit the telecast of up to three (3) minutes in the aggregate of any match in respect of any local, regional, national or international news or sports news programming.

X. EXHIBITS

EXAMPLE 1

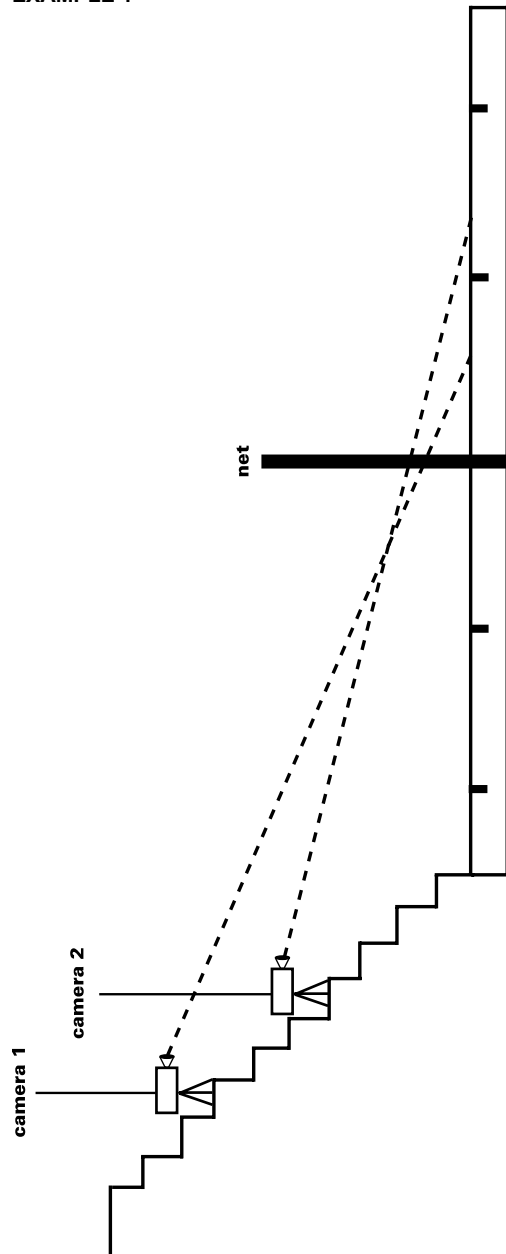

EXAMPLE 2

Standard Camera Position for Tennis Broadcast

X. EXHIBITS

EXAMPLE 2

Standard Camera Positions for Tennis Broadcast

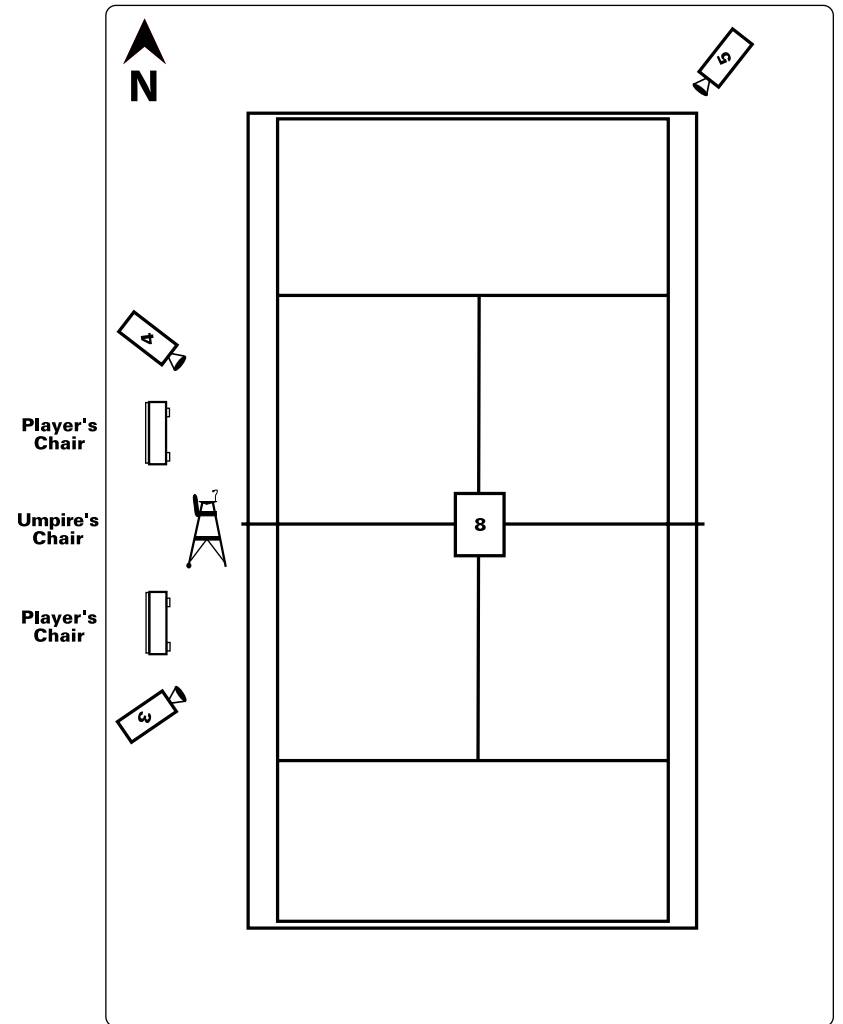

X. EXHIBITS

EXHIBIT D - Attendance Standards

ATP Tour Tournament Attendance Quality Standards

Set forth below for each of the tournament classes are two attendance standard recommendations. In each year of operation, each ATP Tour tournament class member is expected to meet both of these recommendations. A member not meeting the recommended attendance standard three (3) years in a row (excluding extenuating circumstances) must present to the ATP Standards Committee a strategic plan on how they will meet the recommended standard in future years.

1) Recommended Attendance Standards

a) ATP Tour Masters 1000 & ATP Tour 500 tournaments

The recommended total attendance is calculated as follows:

- Start of main draw through Thursday.
 - o 50% of the actual seating capacity* for match courts, as specified in section 1.20, multiplied by the number of sessions.
- Friday through Sunday
 - o 75% of the Center Court capacity* multiplied by the number of sessions.
- The sum of these totals determine the recommended total attendance for the week.

b) ATP Tour 250

The recommended total attendance is calculated as follows:

- Start of main draw through Tuesday.
 - o 25% of the Center Court seating capacity multiplied by the number of sessions.
- Wednesday and Thursday
 - o 50% of the Center Court seating capacity multiplied by the number of sessions.
- Friday through Sunday
 - o 75% of the Center Court capacity multiplied by the number of sessions.
- The sum of these totals determine the recommended total attendance for the week.

* For events that cover Center Court seats, available seats on that day will be used to determine percentages, however, this number may not be less than the minimum requirement.

2) Minimum Weekend Attendance

The average minimum attendance per session during the final weekend of play is recommended to be in excess of 75% of capacity for the Center Court.

3) Measurement

- a) On a daily basis during the operation of each tournament, each tournament class member shall provide the ATP Supervisor with attendance figures in writing on a per session basis for each session held during the prior day. Such report shall set forth both total spectator attendance and the percentage of capacity. Each tournament class member shall promptly provide the ATP Supervisor or other member of the ATP staff with any backup necessary to verify its spectator attendance figures if such information is requested.

X. EXHIBITS

- b) If the ATP Supervisor has any questions concerning the accuracy of such spectator attendance figures based upon his observation of the event, the ATP Supervisor shall promptly so notify the tournament class member and shall inform the member of what he believes is a more accurate spectator attendance count. In such circumstance, the burden will be on the tournament class member to persuade the ATP Supervisor of the accuracy of its figures. The final report of the ATP Supervisor shall be conclusive.

X. EXHIBITS

EXHIBIT E - Virtual Insertion

Each ATP Tournament must comply with the following in order to use virtual insertion technology in telecasts:

- 1) Each telecast of an ATP Tour tournament using virtually inserted signage must receive the prior approval of ATP.
- 2) The company and methodology used to produce virtually inserted signage must meet quality and technical standards and be pre-approved by ATP.
- 3) Virtually inserted signage may be inserted only in existing signage positions.
- 4) Virtually inserted signage may be altered between points if synchronized with the change of Electronically Inserted Signage if in use.
- 5) Only static logos may be inserted. No moving logos or videos may be inserted.
- 6) Virtually inserted signage must be consistent in color, graphical look and size with the Tournament's other permanent signage.

X. EXHIBITS

EXHIBIT F - Lighting

Lighting Form



Tournament City: _____
Tournament Number: _____

LIGHTING MEASUREMENTS

Date of Measurement: _____

Tournament Supervisor: _____

Referee: _____

Site name: _____

COURT NAME: _____

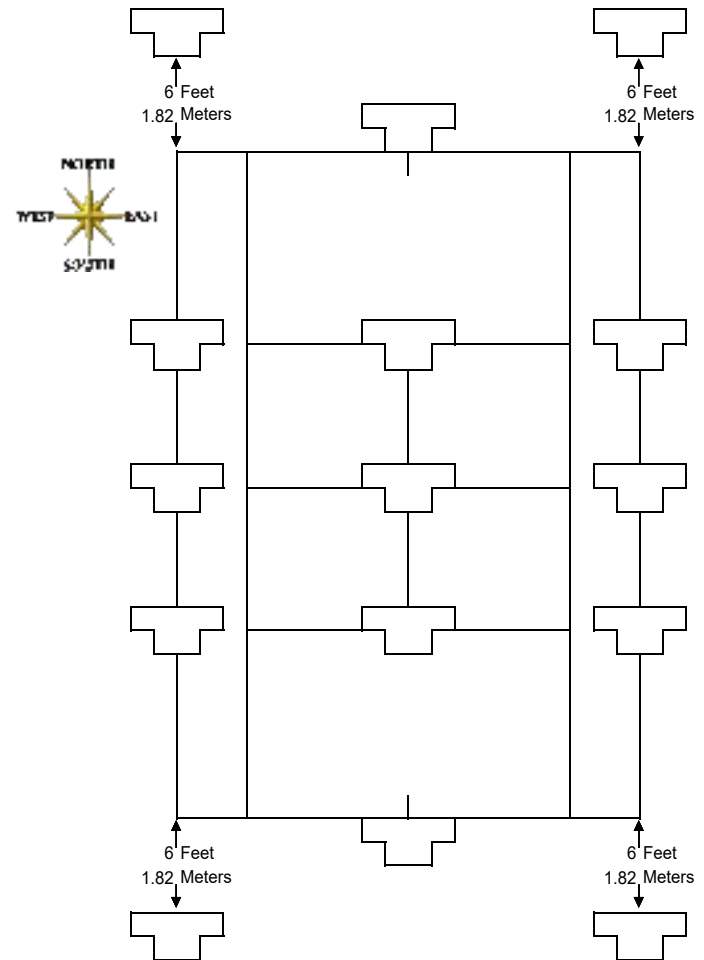

X. EXHIBITS

EXHIBIT G - ATP Challenger Tour Logo (Print & Promotional Materials)

Basic Guidelines:

- 1) The brand mark should never be modified in any way or redrawn. The three fixed elements (the ATP Challenger Tour logo type; the official ATP logo; the rectangular background field) should never be separated from each other.
- 2) Whenever possible, the ATP Challenger Tour brand mark should be reproduced in color. The one color version is for use only when color restrictions apply.
- 3) The ATP Challenger Tour brand mark should not be used on a background that may make it appear indistinct. It should always appear on an uncluttered background to ensure clarity.
- 4) The ATP Challenger Tour brand mark must be positioned in its own clear space, standing apart from other images, brand marks and/or text. In order to achieve this, the ATP Challenger Tour brand mark should always be surrounded by a minimum clear zone, at least equal in width to the ATP logo in the logotype.
- 5) The ATP Challenger Tour brand mark should not be positioned like a sponsor. It should be separated from sponsor logos in order to stand out as an endorsement of the quality and authenticity of the tournament.

EXHIBIT H - ATP Challenger Tour Logo (On-Court Version)



ATP Challenger Tour tournaments must only use the on-court version of the logo, shown above, for any signage around the court perimeter.

X. EXHIBITS

EXHIBIT I - Rules of Tennis

Rule 1	FOREWORD
Rule 2	THE COURT
Rule 3	PERMANENT FIXTURES
Rule 4	THE BALL
Rule 5	THE RACKET
Rule 6	SCORE IN A GAME
Rule 7	SCORE IN A SET
Rule 8	SCORE IN A MATCH
Rule 9	SERVER & RECEIVER
Rule 10	CHOICE OF ENDS & SERVICE
Rule 11	CHANGE OF ENDS
Rule 12	BALL IN PLAY
Rule 13	BALL TOUCHES A LINE
Rule 14	BALL TOUCHES A PERMANENT FIXTURE
Rule 15	ORDER OF SERVICE
Rule 16	ORDER OF RECEIVING IN DOUBLES
Rule 17	THE SERVICE
Rule 18	SERVING
Rule 19	FOOTFAULT
Rule 20	SERVICE FAULT
Rule 21	SECOND SERVICE
Rule 22	WHEN TO SERVE & RECEIVE
Rule 23	THE LET DURING A SERVICE
Rule 24	THE LET
Rule 25	PLAYER LOSES POINT
Rule 26	A GOOD RETURN
Rule 27	HINDRANCE
Rule 28	CORRECTING ERRORS
Rule 29	ROLE OF COURT OFFICIALS
Rule 30	CONTINUOUS PLAY
Rule 31	COACHING
	PLAYER ANALYSIS TECHNOLOGY
	RULES OF WHEELCHAIR TENNIS
	AMENDMENT TO THE RULES OF TENNIS
Appendix I	THE BALL
	CLASSIFICATION OF COURT SURFACE PACE
Appendix II	THE RACKET
Appendix III	PLAYER ANALYSIS TECHNOLOGY
Appendix IV	ADVERTISING
Appendix V	ALTERNATIVE PROCEDURES AND SCORING METHODS
Appendix VI	ROLE OF COURT OFFICIALS
Appendix VII	10 AND UNDER TENNIS COMPETITION
Appendix VIII	PLAN OF THE COURT
Appendix IX	SUGGESTIONS ON HOW TO MARK A COURT
Appendix X	RULES OF BEACH TENNIS
Appendix XI	PROCEDURES FOR REVIEW AND HEARINGS ON THE RULES OF TENNIS

References to the International Tennis Federation or ITF shall hereafter mean ITF Limited.

X. EXHIBITS

FOREWORD

The International Tennis Federation (ITF) is the governing body of the game of tennis and its duties and responsibilities include PROTECTING THE INTEGRITY OF THE GAME THROUGH determination of the Rules of Tennis.

To assist the ITF in carrying out this responsibility, the ITF has appointed a Rules of Tennis Committee which continually monitors the game and its rules, and when considered necessary makes recommendations for changes to the Board of Directors of the ITF who in turn make recommendations to the Annual General Meeting of the ITF which is the ultimate authority for making any changes to the Rules of Tennis.

Appendix V lists approved alternative procedures and scoring methods. In addition, on its own behalf or on application by interested parties, certain variations to the rules may be approved by the ITF for trial purposes only at a limited number of tournaments or events and/or for a limited time period. Such variations are not included in the published rules and require a report to the ITF on the conclusion of the approved trial.

Note: If there are any inconsistencies between the English version and Rules of Tennis translated into other languages, the English version shall prevail.

1. THE COURT

The court shall be a rectangle, 78 feet (23.77 m) long and, for singles matches, 27 feet (8.23 m) wide. For doubles matches, the court shall be 36 feet (10.97 m) wide.

The court shall be divided across the middle by a net suspended by a cord or metal cable which shall pass over or be attached to two net posts at a height of 3 ½ feet (1.07 m). The net shall be fully extended so that it completely fills the space between the two net posts and it must be of sufficiently small mesh to ensure that a ball cannot pass through it. The height of the net shall be 3 feet (0.914 m) at the Center, where it shall be held down tightly by a strap. A band shall cover the cord or metal cable and the top of the net. The strap and band shall be completely white.

- The maximum diameter of the cord or metal cable shall be 1/3 inch (0.8 cm).
- The maximum width of the strap shall be 2 inches (5 cm).
- The band shall be between 2 inches (5 cm) and 2 ½ inches (6.35 cm) deep on each side.

For doubles matches, the centers of the net posts shall be 3 feet (0.914 m) outside the doubles court on each side.

For singles matches, if a singles net is used, the centers of the net posts shall be 3 feet (0.914 m) outside the singles court on each side. If a doubles net is used, then the net shall be supported, at a height of 3 ½ feet (1.07 m), by two singles sticks, the centers of which shall be 3 feet (0.914 m) outside the singles court on each side.

- The net posts shall not be more than 6 inches (15 cm) square or 6 inches (15 cm) in diameter.
- The singles sticks shall not be more than 3 inches (7.5 cm) square or 3 inches (7.5 cm) in diameter.
- The net posts and singles sticks shall not be more than 1 inch (2.5 cm) above the top of the net cord.

X. EXHIBITS

The lines at the ends of the court are called baselines and the lines at the sides of the court are called sidelines.

Two lines shall be drawn between the singles sidelines, 21 feet (6.40 m) from each side of the net, parallel with the net. These lines are called the service lines. On each side of the net, the area between the service line and the net shall be divided into two equal parts, the service courts, by the center service line. The center service line shall be drawn parallel with the singles sidelines and half way between them.

Each baseline shall be divided in half by a center mark, 4 inches (10 cm) in length, which shall be drawn inside the court and parallel with the singles sidelines.

- The center service line and center mark shall be 2 inches (5 cm) wide.
- The other lines of the court shall be between 1 inch (2.5 cm) and 2 inches (5 cm) wide, except that the baselines may be up to 4 inches (10 cm) wide.

All court measurements shall be made to the outside of the lines and all lines of the court shall be of the same color clearly contrasting with the color of the surface.

No advertising is allowed on the court, net, strap, band, net posts or singles sticks except as provided in Appendix IV.

In addition to the court described above, the court designated as “Red” and the court designated as “Orange” in Appendix VII can be used for 10 and under tennis competition.

Note: Guidelines for minimum distances between the baseline and backstops and between the sidelines and sidestops can be found in Appendix IX.

2. PERMANENT FIXTURES

The permanent fixtures of the court include the backstops and sidestops, the spectators, the stands and seats for spectators, all other fixtures around and above the court, the Chair Umpire, Line Umpires, net umpire and ball persons when in their recognized positions.

In a singles match played with a doubles net and singles sticks, the net posts and the part of the net outside the singles sticks are permanent fixtures and are not considered as net posts or part of the net.

3. THE BALL

Balls, which are approved for play under the Rules of Tennis, must comply with the specifications in Appendix I.

The International Tennis Federation shall rule on the question of whether any ball or prototype complies with Appendix I or is otherwise approved, or not approved, for play. Such ruling may be taken on its own initiative or upon application by any party with a bona fide interest therein, including any player, equipment manufacturer or National Association or members thereof. Such rulings and applications shall be made in accordance with the applicable Review and Hearing Procedures of the International Tennis Federation (see Appendix X).

X. EXHIBITS

The event organizers must announce in advance of the event:

- a. The number of balls for play (2, 3, 4 or 6).
- b. The ball change policy, if any.

Ball changes, if any, can be made either:

- i) After an agreed odd number of games, in which case, the first ball change in the match shall take place two games earlier than for the rest of the match, to make allowance for the warm-up. A tie-break game counts as one game for the ball change. A ball change shall not take place at the beginning of a tie-break game. In this case, the ball change shall be delayed until the beginning of the second game of the next set; or
- ii. At the beginning of a set

If a ball gets broken during play, the point shall be replayed.

Case 1: *If a ball is soft at the end of a point, should the point be replayed?*

Decision: *If the ball is soft, not broken, the point shall not be replayed.*

Note: Any ball to be used in a tournament which is played under the Rules of Tennis, must be named on the official ITF list of approved balls issued by the International Tennis Federation.

4. THE RACKET

Rackets, which are approved for play under the Rules of Tennis, must comply with the specifications in Appendix II.

The International Tennis Federation shall rule on the question of whether any racket or prototype complies with Appendix II or is otherwise approved, or not approved, for play. Such ruling may be undertaken on its own initiative, or upon application by any party with a bona fide interest therein, including any player, equipment manufacturer or National Association or members thereof. Such rulings and applications shall be made in accordance with the applicable Review and Hearing Procedures of the International Tennis Federation (see Appendix X).

Case 1: *Is more than one set of strings allowed on the hitting surface of a racket?*

Decision: *No. The rule mentions a pattern (not patterns) of crossed strings. (See Appendix II)*

Case 2: *Is the stringing pattern of a racket considered to be generally uniform and flat if the strings are on more than one plane?*

Decision: *No.*

Case 3: *Can vibration damping devices be placed on the strings of a racket? If so, where can they be placed?*

Decision: *Yes, but these devices may only be placed outside the pattern of the crossed strings.*

Case 4: *During a point, a player accidentally breaks the strings. Can the player continue to play another point with this racket?*

Decision: *Yes, except where specifically prohibited by event organizers.*

X. EXHIBITS

Case 5: *Is a player allowed to use more than one racket at any time during play?*

Decision: *No.*

Case 6: *Can a battery that affects playing characteristics be incorporated into a racket?*

Decision: *No. A battery is prohibited because it is an energy source, as are solar cells and other similar devices.*

5. SCORE IN A GAME

- a. Standard game

A standard game is scored as follows with the server's score being called first:

No point	-	"Love"
First point	-	"15"
Second point	-	"30"
Third point	-	"40"
Fourth point	-	"Game"

except that if each player/team has won three points, the score is "Deuce". After "Deuce", the score is "Advantage" for the player/team who wins the next point. If that same player/team also wins the next point, that player/team wins the "Game"; if the opposing player/team wins the next point, the score is again "Deuce". A player/team needs to win two consecutive points immediately after "Deuce" to win the "Game".

b. Tie-break game

During a tie-break game, points are scored "Zero", "1", "2", "3", etc. The first player/team to win seven points wins the "Game" and "Set", provided there is a margin of two points over the opponent(s). If necessary, the tie-break game shall continue until this margin is achieved.

The player whose turn it is to serve shall serve the first point of the tie-break game. The following two points shall be served by the opponent(s) (in doubles, the player of the opposing team due to serve next). After this, each player/team shall serve alternately for two consecutive points until the end of the tie-break game (in doubles, the rotation of service within each team shall continue in the same order as during that set).

The player/team whose turn it was to serve first in the tie-break game shall be the receiver in the first game of the following set.

Additional approved alternative scoring methods can be found in Appendix V.

6. SCORE IN A SET

There are different methods of scoring in a set. The two main methods are the "Advantage Set" and the "Tie-break Set". Either method may be used provided that the one to be used is announced in advance of the event. If the "Tie-break Set" method is

X. EXHIBITS

to be used, it must also be announced whether the final set will be played as a “Tie-break Set” or an “Advantage Set”.

a. “Advantage Set”

The first player/team to win six games wins that “Set”, provided there is a margin of two games over the opponent(s). If necessary, the set shall continue until this margin is achieved.

b. “Tie-break Set”

The first player/team to win six games wins that “Set”, provided there is a margin of two games over the opponent(s). If the score reaches six games all, a tie-break game shall be played.

Additional approved alternative scoring methods can be found in Appendix V.

7. SCORE IN A MATCH

A match can be played to the best of 3 sets (a player/team needs to win 2 sets to win the match) or to the best of 5 sets (a player/team needs to win 3 sets to win the match).

Additional approved alternative scoring methods can be found in Appendix V.

8. SERVER & RECEIVER

The players/teams shall stand on opposite sides of the net. The server is the player who puts the ball into play for the first point. The receiver is the player who is ready to return the ball served by the server.

Case 1: *Is the receiver allowed to stand outside the lines of the court?*

Decision: *Yes. The receiver may take any position inside or outside the lines on the receiver’s side of the net.*

9. CHOICE OF ENDS & SERVICE

The choice of ends and the choice to be server or receiver in the first game shall be decided by toss before the warm-up starts. The player/team who wins the toss may choose:

- To be server or receiver in the first game of the match, in which case the opponent(s) shall choose the end of the court for the first game of the match; or
- The end of the court for the first game of the match, in which case the opponent(s) shall choose to be server or receiver for the first game of the match; or
- To require the opponent(s) to make one of the above choices.

Case 1: *Do both players/teams have the right to new choices if the warm-up is stopped and the players leave the court?*

Decision: *Yes. The result of the original toss stands, but new choices may be made by both players/teams.*

X. EXHIBITS

10. CHANGE OF ENDS

The players shall change ends at the end of the first, third and every subsequent odd game of each set. The players shall also change ends at the end of each set unless the total number of games in that set is even, in which case the players change ends at the end of the first game of the next set.

During a tie-break game, players shall change ends after every six points.

Additional approved alternative procedures can be found in Appendix V.

11 BALL IN PLAY

Unless a fault or a let is called, the ball is in play from the moment the server hits the ball, and remains in play until the point is decided.

12. BALL TOUCHES A LINE

If a ball touches a line, it is regarded as touching the court bounded by that line.

13. BALL TOUCHES A PERMANENT FIXTURE

If the ball in play touches a permanent fixture after it has hit the correct court, the player who hit the ball wins the point. If the ball in play touches a permanent fixture before it hits the ground, the player who hit the ball loses the point.

14. ORDER OF SERVICE

At the end of each standard game, the receiver shall become the server and the server shall become the receiver for the next game.

In doubles, the team due to serve in the first game of each set shall decide which player shall serve for that game. Similarly, before the second game starts, their opponents shall decide which player shall serve for that game. The partner of the player who served in the first game shall serve in the third game and the partner of the player who served in the second game shall serve in the fourth game. This rotation shall continue until the end of the set.

15. ORDER OF RECEIVING IN DOUBLES

The team which is due to receive in the first game of a set shall decide which player shall receive the first point in the game. Similarly, before the second game starts, their opponents shall decide which player shall receive the first point of that game. The player who was the receiver’s partner for the first point of the game shall receive the second point and this rotation shall continue until the end of the game and the set.

After the receiver has returned the ball, either player in a team can hit the ball.

Case 1: *Is one member of a doubles team allowed to play alone against the opponents?*

Decision: *No.*

X. EXHIBITS

16. THE SERVICE

Immediately before starting the service motion, the server shall stand at rest with both feet behind (i.e. further from the net than) the baseline and within the imaginary extensions of the center mark and the sideline.

The server shall then release the ball by hand in any direction and hit the ball with the racket before the ball hits the ground. The service motion is completed at the moment that the player's racket hits or misses the ball. A player who is able to use only one arm may use the racket for the release of the ball.

17 SERVING

When serving in a standard game, the server shall stand behind alternate halves of the court, starting from the right half of the court in every game.

In a tie-break game, the service shall be served from behind alternate halves of the court, with the first served from the right half of the court.

The service shall pass over the net and hit the service court diagonally opposite, before the receiver returns it.

18. FOOT FAULT

During the service motion, the server shall not:

- a. Change position by walking or running, although slight movements of the feet are permitted; or
- b. Touch the baseline or the court with either foot; or
- c. Touch the area outside the imaginary extension of the sideline with either foot; or
- d. Touch the imaginary extension of the center mark with either foot.

If the server breaks this rule it is a "Foot Fault".

Case 1: *In a singles match, is the server allowed to serve standing behind the part of the baseline between the singles sideline and the doubles sideline?*

Decision: No.

Case 2: *Is the server allowed to have one or both feet off the ground?*

Decision: Yes.

19. SERVICE FAULT

The service is a fault if:

- a. The server breaks rules 16, 17 or 18; or
- b. The server misses the ball when trying to hit it; or
- c. The ball served touches a permanent fixture, singles stick or net post before it hits the ground; or
- d. The ball served touches the server or server's partner, or anything the server or server's partner is wearing or carrying.

X. EXHIBITS

Case 1: *After tossing a ball to serve, the server decides not to hit it and catches it instead. Is this a fault?*

Decision: No. A player, who tosses the ball and then decides not to hit it, is allowed to catch the ball with the hand or the racket, or to let the ball bounce.

Case 2: *During a singles match played on a court with net posts and singles sticks, the ball served hits a singles stick and then hits the correct service court. Is this a fault?*

Decision: Yes.

20. SECOND SERVICE

If the first service is a fault, the server shall serve again without delay from behind the same half of the court from which that fault was served, unless the service was from the wrong half.

21. WHEN TO SERVE & RECEIVE

The server shall not serve until the receiver is ready. However, the receiver shall play to the reasonable pace of the server and shall be ready to receive within a reasonable time of the server being ready.

A receiver who attempts to return the service shall be considered as being ready. If it is demonstrated that the receiver is not ready, the service cannot be called a fault.

22. THE LET DURING A SERVICE

The service is a let if:

- a. The ball served touches the net, strap or band, and is otherwise good; or, after touching the net, strap or band, touches the receiver or the receiver's partner or anything they wear or carry before hitting the ground; or
- b. The ball is served when the receiver is not ready.

In the case of a service let, that particular service shall not count, and the server shall serve again, but a service let does not cancel a previous fault.

Additional approved alternative procedures can be found in Appendix V.

23. THE LET

In all cases when a let is called, except when a service let is called on a second service, the whole point shall be replayed.

Case 1: *When the ball is in play, another ball rolls onto court. A let is called. The server had previously served a fault. Is the server now entitled to a first service or second service?*

Decision: First service. The whole point must be replayed.

24. PLAYER LOSES POINT

The point is lost if:

- a. The player serves two consecutive faults; or

X. EXHIBITS

- b. The player does not return the ball in play before it bounces twice consecutively; or
- c. The player returns the ball in play so that it hits the ground, or before it bounces, an object, outside the correct court; or
- d. The player returns the ball in play so that, before it bounces, it hits a permanent fixture; or
- e. The receiver returns the service before it bounces; or
- f. The player deliberately carries or catches the ball in play on the racket or deliberately touches it with the racket more than once; or
- g. The player or the racket, whether in the player's hand or not, or anything which the player is wearing or carrying touches the net, net posts/singles sticks, cord or metal cable, strap or band, or the opponent's court at any time while the ball is in play; or
- h. The player hits the ball before it has passed the net; or
- i. The ball in play touches the player or anything that the player is wearing or carrying, except the racket; or
- j. The ball in play touches the racket when the player is not holding it; or
- k. The player deliberately and materially changes the shape of the racket when the ball is in play; or
- l. In doubles, both players touch the ball when returning it.

Case 1: *After the server has served a first service, the racket falls out of the server's hand and touches the net before the ball has bounced. Is this a service fault, or does the server lose the point?*

Decision: *The server loses the point because the racket touches the net while the ball is in play.*

Case 2: *After the server has served a first service, the racket falls out of the server's hand and touches the net after the ball has bounced outside the correct service court. Is this a service fault, or does the server lose the point?*

Decision: *This is a service fault because when the racket touched the net the ball was no longer in play.*

Case 3: *In a doubles match, the receiver's partner touches the net before the ball that has been served touches the ground outside the correct service court. What is the correct decision?*

Decision: *The receiving team loses the point because the receiver's partner touched the net while the ball was in play.*

Case 4: *Does a player lose the point if an imaginary line in the extension of the net is crossed before or after hitting the ball?*

Decision: *The player does not lose the point in either case provided the player does not touch the opponent's court.*

Case 5: *Is a player allowed to jump over the net into the opponent's court while the ball is in play?*

Decision: *No. The player loses the point.*

Case 6: *A player throws the racket at the ball in play. Both the racket and the ball land in the court on the opponent's side of the net and the opponent(s) is unable to reach the ball. Which player wins the point?*

Decision: *The player who threw the racket at the ball loses the point.*

X. EXHIBITS

Case 7: *A ball that has just been served hits the receiver or in doubles the receiver's partner before it touches the ground. Which player wins the point?*

Decision: *The server wins the point, unless it is a service let.*

Case 8: *A player standing outside the court hits the ball or catches it before it bounces and claims the point because the ball was definitely going out of the correct court.*

Decision: *The player loses the point, unless it is a good return, in which case the point continues.*

25. A GOOD RETURN

It is a good return if:

- a. The ball touches the net, net posts/singles sticks, cord or metal cable, strap or band, provided that it passes over any of them and hits the ground within the correct court; except as provided in Rule 2 and 24 (d); or
- b. After the ball in play has hit the ground within the correct court and has spun or been blown back over the net, the player reaches over the net and plays the ball into the correct court, provided that the player does not break Rule 24; or
- c. The ball is returned outside the net posts, either above or below the level of the top of the net, even though it touches the net posts, provided that it hits the ground in the correct court; except as provided in Rules 2 and 24 (d); or
- d. The ball passes under the net cord between the singles stick and the adjacent net post without touching either net, net cord or net post and hits the ground in the correct court; or
- e. The player's racket passes over the net after hitting the ball on the player's own side of the net and the ball hits the ground in the correct court; or
- f. The player hits the ball in play, which hits another ball lying in the correct court.

Case 1: *A player returns a ball which then hits a singles stick and hits the ground in the correct court. Is this a good return?*

Decision: *Yes. However, if the ball is served and hits the singles stick, it is a service fault.*

Case 2: *A ball in play hits another ball which is lying in the correct court. What is the correct decision?*

Decision: *Play continues. However, if it is not clear that the actual ball in play has been returned, a let should be called.*

26. HINDRANCE

If a player is hindered in playing the point by a deliberate act of the opponent(s), the player shall win the point.

However, the point shall be replayed if a player is hindered in playing the point by either an unintentional act of the opponent(s), or something outside the player's own control (not including a permanent fixture).

Case 1: *Is an unintentional double hit a hindrance?*

Decision: *No. See also Rule 24 (f).*

Case 2: *A player claims to have stopped play because the player thought that the opponent(s) was being hindered. Is this a hindrance?*

X. EXHIBITS

Decision: No, the player loses the point.

Case 3: A ball in play hits a bird flying over the court. Is this a hindrance?

Decision: Yes, the point shall be replayed.

Case 4: During a point, a ball or other object that was lying on the player's side of the net when the point started hinders the player. Is this a hindrance?

Decision: No.

Case 5: In doubles, where are the server's partner and receiver's partner allowed to stand?

Decision: The server's partner and the receiver's partner may take any position on their own side of the net, inside or outside the court. However, if a player is creating a hindrance to the opponent(s), the hindrance rule should be used.

27. CORRECTING ERRORS

As a principle, when an error in respect of the Rules of Tennis is discovered, all points previously played shall stand. Errors so discovered shall be corrected as follows:

- a. During a standard game or a tie-break game, if a player serves from the wrong half of the court, this should be corrected as soon as the error is discovered and the server shall serve from the correct half of the court according to the score. A fault that was served before the error was discovered shall stand.
- b. During a standard game or a tie-break game, if the players are at the wrong ends of the court, the error should be corrected as soon as it is discovered and the server shall serve from the correct end of the court according to the score.
- c. If a player serves out of turn during a standard game, the player who was originally due to serve shall serve as soon as the error is discovered. However, if a game is completed before the error is discovered the order of service shall remain as altered. In this case, any ball change to be made after an agreed number of games should be made one game later than originally scheduled.
A fault that was served by the opponents(s) before the error was discovered shall not stand.
In doubles, if the partners of one team serve out of turn, a fault that was served before the error was discovered shall stand.
- d. If a player serves out of turn during a tie-break game and the error is discovered after an even number of points have been played, the error is corrected immediately. If the error is discovered after an odd number of points have been played, the order of service shall remain as altered.
A fault that was served by the opponent(s) before the error was discovered shall not stand.
In doubles, if the partners of one team serve out of turn, a fault that was served before the error was discovered shall stand.
- e. During a standard game or a tie-break game in doubles, if there is an error in the order of receiving, this shall remain as altered until the end of the game in which the error is discovered. For the next game in which they are the receivers in that set, the partners shall then resume the original order of receiving.

X. EXHIBITS

- f. If in error a tie-break game is started at 6 games all, when it was previously agreed that the set would be an "Advantage set", the error shall be corrected immediately if only one point has been played. If the error is discovered after the second point is in play, the set will continue as a "Tie-break set".
- g. If in error a standard game is started at 6 games all, when it was previously agreed that the set would be a "Tie-break set", the error shall be corrected immediately if only one point has been played. If the error is discovered after the second point is in play, the set will continue as an "Advantage set" until the score reaches 8 games all (or a higher even number), when a tie-break game shall be played.
- h. If in error an "Advantage set" or "Tie-break set" is started, when it was previously agreed that the final set would be a match tie-break, the error shall be corrected immediately if only one point has been played. If the error is discovered after the second point is in play, the set will continue either until a player or team wins three games (and therefore the set) or until the score reaches 2 games all, when a match tie-break shall be played. However, if the error is discovered after the second point of the fifth game has started, the set will continue as a "Tie-break set". (See Appendix V)
- i. If the balls are not changed in the correct sequence, the error shall be corrected when the player/team who should have served with new balls is next due to serve a new game. Thereafter the balls shall be changed so that the number of games between ball changes shall be that originally agreed. Balls should not be changed during a game.

28. ROLE OF COURT OFFICIALS

For matches where officials are appointed, their roles and responsibilities can be found in Appendix VI.

29. CONTINUOUS PLAY

As a principle, play should be continuous, from the time the match starts (when the first service of the match is put in play) until the match finishes.

- a. Between points, a maximum of twenty-five (25) seconds is allowed. When the players change ends at the end of a game, a maximum of ninety (90) seconds are allowed. However, after the first game of each set and during a tie-break game, play shall be continuous and the players shall change ends without a rest.
At the end of each set there shall be a set break of a maximum of one hundred and twenty (120) seconds.
The maximum time starts from the moment that one point finishes until the first service is struck for the next point.
Event organizers may apply for ITF approval to extend the ninety (90) seconds allowed when the players change ends at the end of a game and the one hundred and twenty (120) seconds allowed at a set break.
- b. If, for reasons outside the player's control, clothing, footwear or necessary equipment (excluding the racket) is broken or needs to be replaced, the player may be allowed reasonable extra time to rectify the problem.
- c. No extra time shall be given to allow a player to recover condition. However, a player suffering from a treatable medical condition may be allowed one medical time-out of three minutes for the treatment of that medical condition.

X. EXHIBITS

A limited number of toilet/change of attire breaks may also be allowed, if this is announced in advance of the event.

- d. Event organizers may allow a rest period of a maximum of ten (10) minutes if this is announced in advance of the event. This rest period can be taken after the 3rd set in a best of 5 sets match, or after the 2nd set in a best of 3 sets match.
- e. The warm-up time shall be a maximum of five (5) minutes, unless otherwise decided by the event organizers.

30. COACHING

Coaching is considered to be communication, advice or instruction of any kind and by any means to a player.

In team events where there is a team captain sitting on-court, the team captain may coach the player(s) during a set break and when the players change ends at the end of a game, but not when the players change ends after the first game of each set and not during a tie-break game.

In all other matches, coaching is not allowed.

Case 1: *Is a player allowed to be coached, if the coaching is given by signals in a discreet way?*

Decision: No.

Case 2: *Is a player allowed to receive coaching when play is suspended?*

Decision: Yes.

Case 3: *Is a player allowed to receive on-court coaching during a match?*

Decision: *Sanctioning bodies may apply to the ITF to have on-court coaching allowed. In events where on-court coaching is allowed, designated coaches may enter the court and coach their players under procedures decided by the sanctioning body.*

31. PLAYER ANALYSIS TECHNOLOGY

Player analysis technology, that is approved for play under the Rules of Tennis, must comply with the specifications in Appendix III.

The International Tennis Federation shall rule on the question of whether any such equipment is approved, or not approved. Such ruling may be taken on its own initiative, or upon application by any party with a bona fide interest therein, including any player, equipment manufacturer or National Association or members thereof. Such rulings and applications shall be made in accordance with the applicable Review and Hearing Procedures of the International Tennis Federation (see Appendix X).

RULES OF WHEELCHAIR TENNIS

The game of wheelchair tennis follows the ITF Rules of Tennis with the following exceptions.

a. The Two Bounce Rule

The wheelchair tennis player is allowed two bounces of the ball. The player must return the ball before it hits the ground a third time. The second bounce can be either in or out of the court boundaries.

X. EXHIBITS

b. The Wheelchair

The wheelchair is considered part of the body and all applicable rules, which apply to a player's body, shall apply to the wheelchair.

c. The Service

The service shall be delivered in the following manner.

- i. Immediately before commencing the service, the server shall be in a stationary position. The server shall then be allowed one push before striking the ball.
- ii. The server shall throughout the delivery of the service not touch with any wheel, any area other than that behind the baseline within the imaginary extension of the center mark and sideline.
- iii. If conventional methods for the service are physically impossible for a quadriplegic player, then the player or an individual may drop the ball for such a player. However, the same method of serving must be used each time.

d. Player Loses Point

A player loses a point if:

- i. The player fails to return the ball before it has touched the ground three times; or
- ii. Subject to rule f) below the player uses any part of their feet or lower extremities as brakes or as stabilizers while delivering service, stroking a ball, turning or stopping against the ground or against any wheel while the ball is in play; or
- iii. The player fails to keep one buttock in contact with their wheelchair seat when contacting the ball.

e. The Wheelchair

Wheelchairs used in all competitions played under the Rules of Wheelchair Tennis must comply with the following specifications:

- i. The wheelchair may be constructed of any material provided that such material is non-reflective and does not constitute a hindrance to the opponent.
- ii. Wheels may have a single pushrim only. No changes to the wheelchair that afford the player a mechanical advantage are permitted, such as levers or gears. During normal play, wheels shall not leave permanent marks on, or otherwise damage, the court surface.
- iii. Subject to Rule e(v), players shall use only the wheels (including pushrims) to propel the wheelchair. No steering, braking or gearing or other device that may assist operation of the wheelchair, including energy storage systems, is permitted.
- iv. The height of the seat (including cushion) shall be fixed and players' buttocks shall remain in contact with the seat during the playing of a point. Strapping may be used to secure the player to the wheelchair.
- v. Players who meet the requirements of Article 10 of the ITF Wheelchair Tennis Classification Rules may use a wheelchair powered by electric motor(s) (a "powered wheelchair"). Powered wheelchairs must not be able to exceed 15 km/h in any direction and shall be controlled by the player only.
- vi. Applications may be made for modifications to the wheelchair for legitimate medical reasons. All such applications shall be submitted to the ITF Sport Science & Medicine Commission for approval a minimum of 60 days prior to intended use in an ITF-sanctioned event.

X. EXHIBITS

A decision to reject a proposed modification may be appealed under Appendix III of the ITF Wheelchair Tennis Regulations.

f. Propelling the Chair with the Foot

- i. If due to lack of capacity a player is unable to propel the wheelchair via the wheel then they may propel the wheelchair using one foot.
- ii. Even if in accordance with rule e) i. above a player is permitted to propel the chair using one foot, no part of the player's foot may be in contact with the ground:
 - a) during the forward motion of the swing, including when the racket strikes the ball;
 - b) from the initiation of the service motion until the racket strikes the ball.
- iii. A player in breach of this rule shall lose the point.

f. Wheelchair/Able-bodied Tennis

Where a wheelchair tennis player is playing with or against an able-bodied person in singles or doubles, the Rules of Wheelchair Tennis shall apply for the wheelchair player while the Rules of Tennis for able-bodied tennis shall apply for the able-bodied player. In this instance, the wheelchair player is allowed two bounces while the able-bodied player is allowed only one bounce.

Note: The definition of lower extremities is: the lower limbs, including the buttocks, hips, thighs, legs, ankles and feet.

AMENDMENT TO THE RULES OF TENNIS

(Article 28 of the Constitution of ITF Ltd)

The official and decisive text to the Rules of Tennis shall be for ever in the English language and no alteration or interpretation of such Rules shall be made except at an Annual General Meeting of the Council, nor unless notice of the Resolution embodying such alterations shall have been received by the ITF in accordance with Article 17 and such Resolution or one having the like effect shall be carried by a majority of two-thirds of the votes recorded in respect of the same.

Any alteration so made shall take effect as from the first day of January following unless the Meeting shall by the like majority decide otherwise.

The Board of Directors shall have power, however, to settle all urgent questions of interpretation subject to confirmation at the General Meeting next following.

This text shall not be altered at any time without the unanimous consent of a General Meeting of the Council.

X. EXHIBITS

APPENDIX I

THE BALL

For all measurements in Appendix I, SI units shall take precedence

- a. The ball shall have a uniform outer surface consisting of a fabric cover except for the Stage 3 (Red) foam ball. If there are any seams they shall be stitchless.
- b. The ball shall conform to one of types specified in the table immediately below or in the table under paragraph (d).

	TYPE 1 (FAST)	TYPE 2 (MEDIUM) ¹	TYPE 3 (SLOW) ²	HIGH ALTITUDE ³
MASS (WEIGHT)	56.0-59.4 grams (1.975-2.095 oz)	56.0-59.4 grams (1.975-2.095 oz)	56.0-59.4 grams (1.975-2.095 oz)	56.0-59.4 grams (1.975-2.095 oz)
SIZE	6.54-6.86 cm (2.57-2.70 in)	6.54-6.86 cm (2.57-2.70 in)	7.00-7.30 cm (2.76-2.87 in)	6.54-6.86 cm (2.57-2.70 in)
REBOUND	138-151 cm (54-60 inches)	135-147 cm (53-58 in)	135-147 cm (53-58 in)	122-135 cm (48-53 in)
FORWARD DEFORMATION⁴	0.56-0.74 cm (0.220-0.291 in)	0.56-0.74 cm (0.220-0.291 in)	0.56-0.74 cm (0.220-0.291 in)	0.56-0.74 cm (0.220-0.291 in)
RETURN DEFORMATION⁴	0.74-1.08 cm (0.291-0.425 in)	0.80-1.08 cm (0.315-0.425 in)	0.80-1.08 cm (0.315-0.425 in)	0.80-1.08 cm (0.315-0.425 in)
COLOR	White or Yellow	White or Yellow	White or Yellow	White or Yellow

Notes:

- ¹ This ball type may be pressurised or pressureless. The pressureless ball shall have an internal pressure that is no greater than 7 kPa (1 psi) and may be used for high altitude play above 1,219 m (4,000 feet) above sea level and shall have been acclimatized for 60 days or more at the altitude of the specific tournament.
- ² This ball type is also recommended for high altitude play on any court surface type above 1,219 m (4,000 feet) above sea level.
- ³ This ball type is pressurised and is specified for high altitude play above 1,219 m (4,000 feet) above sea level only.
- ⁴ The deformation shall be the average of a single reading along each of three perpendicular axes. No two individual readings shall differ by more than 0.08 cm (0.031 inches).

- c. In addition, all ball types specified under paragraph (b) shall conform to the requirements for durability as shown in the following table:

	MASS (WEIGHT)	REBOUND	FORWARD DEFORMATION	RETURN DEFORMATION
MAXIMUM CHANGE¹	0.4 gr (0.014 oz)	4.0 cm (1.6 in)	0.08 cm (0.031 in)	0.10 cm (0.039 in)

Notes:

- ¹ The largest permissible change in the specified properties resulting from the durability test described in the current edition of *ITF Approved Tennis Balls & Classified Court Surfaces*. The durability test uses laboratory equipment to simulate the effects of nine games of play.

X. EXHIBITS

- d. Only the ball types specified in the table below can be used in 10 and under tennis competition:

	STAGE 3 (RED) FOAM	STAGE 3 (RED) STANDARD	STAGE 2 (ORANGE) STANDARD	STAGE 1 (GREEN) STANDARD
MASS (WEIGHT)	25.0-43.0 grams (0.882-1.517 oz)	36.0-49.0 grams (1.270-1.728 oz)	36.0-46.9 grams (1.270-1.654 oz)	47.0-51.5 grams (1.658-1.817 oz)
SIZE	8.00-9.00 cm (3.15-3.54 inches)	7.00-8.00 cm (2.76-3.15 inches)	6.00-6.86 cm (2.36-2.70 inches)	6.30-6.86 cm (2.48-2.70 inches)
REBOUND	85-105 cm (33-41 inches)	90-105 cm (35-41 inches)	105-120 cm (41-47 inches)	120-135 cm (47-53 inches)
FORWARD DEFORMATION ¹	-----	-----	1.40-1.65 cm (0.551-0.650 in.)	0.80-1.05 cm (0.315-0.413 in.)
COLOUR ²	Any	Red and Yellow, or Yellow with a Red dot	Orange and Yel- low, or Yellow with an Orange dot	Yellow with a Green dot

Notes:

- ¹ The deformation shall be the average of a single reading along each of three perpendicular axes. There is no limit on the difference between individual forward deformation readings. There is no specification for return deformation.
 - ² All coloured dots shall be reasonable in size and placement.
- e. All tests for rebound, mass, size, deformation and durability shall be made in accordance with the Regulations described in the current edition of ITF Approved Tennis Balls & Classified Court Surfaces.

CLASSIFICATION OF COURT PACE

The ITF test method used for determining the pace of a court surface is ITF CS 01/02 (ITF Court Pace Rating) as described in the ITF publication entitled "ITF guide to test methods for tennis court surfaces".

Court surfaces which have an ITF Court Pace Rating of 0 to 29 shall be classified as being Category 1 (slow pace). Examples of court surface types which conform to this classification will include most clay courts and other types of unbound mineral surface.

Court surfaces which have an ITF Court Pace Rating of 30 to 34 shall be classified as being Category 2 (medium-slow pace), while court surfaces with an ITF Court Pace Rating of 35 to 39 shall be classified as being Category 3 (medium pace). Examples of court surface types which conform to this classification will include most acrylic coated surfaces plus some carpet surfaces.

Court surfaces with an ITF Court Pace Rating of 40 to 44 shall be classified as being Category 4 (medium-fast pace), while court surfaces which have an ITF Court Pace Rating of 45 or more shall be classified as being Category 5 (fast pace). Examples of court surface types which conform to this classification will include most natural grass, artificial grass and some carpet surfaces.

Case 1: Which ball type should be used on which court surface?

X. EXHIBITS

Decision: 3 different types of balls are approved for play under the Rules of Tennis, however:

- a. Ball Type 1 (fast speed) is intended for play on slow pace court surfaces
- b. Ball Type 2 (medium speed) is intended for play on medium-slow, medium and medium-fast pace court surfaces
- c. Ball Type 3 (slow speed) is intended for play on fast pace court surfaces

Note: In addition to the ball types specified under paragraph (b) above, the Stage 1 (Green) ball may be used for all levels of competitive play except for world ranking professional tennis events, Davis Cup and Billie Jean King Cup, the Olympic and Paralympic Tennis Events, World Tennis Tour Men's, Women's and Junior Tournaments and Team events sanctioned by the ITF and affiliated Regional Associations, ITF Senior Circuit and Team events and ITF Wheelchair Tennis Tour Circuit and Team events.

Each National Association shall have the right to decide which national competitive events should use the stage 1 (green) ball.

APPENDIX II

THE RACKET

For all measurements in Appendix II, SI units shall take precedence

- a. The racket shall consist of a frame and string(s). The frame shall consist of a handle and head, and may also include a throat. The head is defined as that part of the racket to which the string(s) connect. The handle is defined as that part of the racket connected to the head which is held by the player in normal use. The throat, where present, is that part of the racket that joins the handle to the head.
- b. The hitting surface, defined as the main area of the stringing pattern bordered by the points of entry of the strings into the head or points of contact of the strings with the head, whichever is the smaller, shall be flat and consist of a pattern of crossed strings, which shall be alternately interlaced or bonded where they cross. The stringing pattern must be generally uniform and, in particular, not less dense in the center than in any other area. The racket shall be designed and strung such that the playing characteristics are identical on both faces.
- c. The racket shall not exceed 73.7 cm (29.0 inches) in overall length, and 31.7 cm (12.5 inches) in overall width. The hitting surface shall not exceed 39.4 cm (15.5 inches) in overall length, when measured parallel to the longitudinal axis of the handle, and 29.2 cm (11.5 inches) in overall width, when measured perpendicular to the longitudinal axis of the handle.
- d. The racket shall be free of any attached object, protrusion or device which makes it possible to change materially the shape of the racket, or its moment of inertia about any principal axis, or to change any physical property which may affect the performance of the racket during the playing of a point. Attached objects, protrusions and devices that are approved as Player Analysis Technology, or that

X. EXHIBITS

are utilised to limit or prevent wear and tear or vibration or, for the frame only, to distribute weight, are permitted. All permissible objects, protrusions and devices must be reasonable in size and placement for their respective purpose(s).

No energy source that in any way could change or affect the playing characteristics of a racket may be built into or attached to a racket.

APPENDIX III

PLAYER ANALYSIS TECHNOLOGY

Player Analysis Technology is equipment that may perform any of the following functions with respect to player performance information:

- A. Recording
- B. Storing
- C. Transmission
- D. Analysis
- E. Communication to a player of any kind and by any means

Player Analysis Technology may record and/or store information during a match. Such information may only be accessed by a player in accordance with Rule 30.

APPENDIX IV

ADVERTISING

1. Advertising is permitted on the net as long as it is placed on the part of the net that is within 3 feet (0.914 m) from the center of the net posts and is produced in such a way that it does not interfere with the vision of the players or the playing conditions.

A mark (non-commercial) of the sanctioning body is permitted on the lower part of the net, minimum 20 inches (0.51 m) from the top of the net, as long as it is produced in such a way that it does not interfere with the vision of the players or the playing conditions.

2. Advertising and other marks or material placed at the back and sides of the court shall be permitted unless it interferes with the vision of the players or the playing conditions.
3. Advertising and other marks or material placed on the court surface outside the lines is permitted unless it interferes with the vision of the players or the playing conditions.
4. Notwithstanding paragraphs (1), (2) and (3) above, any advertising, marks or material placed on the net or placed at the back and sides of the court, or on the court surface outside the lines may not contain white or yellow or other light colors that may interfere with the vision of the players or the playing conditions.

X. EXHIBITS

5. Advertising and other marks or material are not permitted on the court surface inside the lines of the court.

APPENDIX V

ALTERNATIVE PROCEDURES AND SCORING METHODS

SCORE IN A GAME (Rule 5):

This alternatives listed in this Appendix V may be used.

"No-Ad" SCORING METHOD

A "No-Ad" game is scored as follows with the server's score being called first:

No point	-	"Love"
First point	-	"15"
Second point	-	"30"
Third point	-	"40"
Fourth point	-	"Game"

If both players/teams have won three points each, the score is "Deuce" and a deciding point shall be played. The receiver(s) shall choose whether to receive the service from the right half or the left half of the court. In doubles, the players of the receiving team cannot change positions to receive this deciding point. The player/team who wins the deciding point wins the "Game".

In mixed doubles, the player of the same gender as the server shall receive the deciding point. The players of the receiving team cannot change positions to receive the deciding point.

SCORE IN A SET (Rules 6 and 7):

1. SHORT SETS

The first player/team who wins four games wins that set, provided there is a margin of two games over the opponent(s). If the score reaches four games all, a tie-break game shall be played. Alternatively (at the discretion of the sanctioning body), if the score reaches three games all, a tie-break game shall be played.

2. SHORT SET TIE-BREAK

When playing Short Sets only, a Short Set tie-break may be used. The first player/team to win five points wins the "Game" and "Set", with a deciding point if the score reaches four all. The order and number of serves shall be determined by the sanctioning body. Players/Teams will only change ends after the first four points have been played.

3. MATCH TIE-BREAK (7 POINTS)

When the score in a match is one set all, or two sets all in best of five sets matches, one tie-break game shall be played to decide the match. This tie-break game replaces the deciding final set.

X. EXHIBITS

The player/team who first wins seven points shall win this match tie-break and the match provided there is a margin of two points over the opponent(s).

4. MATCH TIE-BREAK (10 POINTS)

When the score in a match is one set all, or two sets all in best of five sets matches, one tie-break game shall be played to decide the match. This tie-break game replaces the deciding final set.

The player/team who first wins ten points shall win this match tie-break and the match provided there is a margin of two points over the opponent(s).

Note: When using the match tie-break to replace the final set:

- the original order of service continues. (Rules 5 and 14)
- in doubles, the order of serving and receiving within the team may be altered, as in the beginning of each set. (Rules 14 and 15)
- before the start of the match tie-break there shall be a 120 seconds set break.
- balls should not be changed before the start of the match tie-break even if a ball change is due.

CHANGE OF ENDS (Rule 10):

During a tie-break game, players shall change ends after the first point and thereafter after every four points.

THE LET DURING A SERVICE (Rule 22):

“NO LET” RULE

This alternative is play without the service let in Rule 22.

When a serve that touches the net, strap or band is in play.

At the discretion of the sanctioning body, when playing doubles using Short Sets in combination with No-Ad scoring and the No-Let rule, either player on the receiving team is permitted to return a serve that touches the net, strap or band and lands within the correct service box.

APPENDIX VI

ROLE OF COURT OFFICIALS

The Referee is the final authority on all questions of tennis law and the Referee's decision is final.

In matches where a Chair Umpire is assigned, the Chair Umpire is the final authority on all questions of fact during the match.

The players have the right to call the Referee to court if they disagree with a Chair Umpire's interpretation of tennis law.

In matches where Line Umpires and net umpires are assigned, they make all calls (including foot-fault calls) relating to that line or net. The Chair Umpire has the right to overrule a Line Umpire or a net umpire if the Chair Umpire is sure that a clear mistake

X. EXHIBITS

has been made. The Chair Umpire is responsible for calling any line (including foot-faults) or net where no Line Umpire or net umpire is assigned.

A Line Umpire who cannot make a call shall signal this immediately to the Chair Umpire who shall make a decision. If the Line Umpire can not make a call, or if there is no Line Umpire, and the Chair Umpire can not make a decision on a question of fact, the point shall be replayed.

In team events where the Referee is sitting on-court, the Referee is also the final authority on questions of fact.

Play may be stopped or suspended at any time the Chair Umpire decides it is necessary or appropriate.

The Referee may also stop or suspend play in the case of darkness, weather or adverse court conditions. When play is suspended for darkness, this should be done at the end of a set, or after an even number of games have been played in the set in progress. After a suspension in play, the score and position of players on-court in the match shall stand when the match resumes.

The Chair Umpire or Referee shall make decisions regarding continuous play and coaching in respect of any Code of Conduct that is approved and in operation.

Case 1: *The Chair Umpire awards the server a first service after an overrule, but the receiver argues that it should be a second service, since the server had already served a fault. Should the Referee be called to court to give a decision?*

Decision: *Yes. The Chair Umpire makes the first decision about questions of tennis law (issues relating to the application of specific facts). However, if a player appeals the Chair Umpire's decision, then the Referee shall be called to make the final decision.*

Case 2: *A ball is called out, but a player claims that the ball was good. May the Referee be called to court to make a decision?*

Decision: *No. The Chair Umpire makes the final decision on questions of fact (issues relating to what actually happened during a specific incident).*

Case 3: *Is a Chair Umpire allowed to overrule a Line Umpire at the end of a point if, in the Chair Umpire's opinion, a clear mistake was made earlier in the point?*

Decision: *No. A Chair Umpire may only overrule a Line Umpire immediately after the clear mistake has been made.*

Case 4: *A Line Umpire calls a ball “Out” and then the player argues that the ball was good. Is the Chair Umpire allowed to overrule the Line Umpire?*

Decision: *No. A Chair Umpire must never overrule as the result of the protest or appeal by a player*

Case 5: *A Line Umpire calls a ball “Out”. The Chair Umpire was unable to see clearly, but thought the ball was in. May the Chair Umpire overrule the Line Umpire?*

Decision: *No. The Chair Umpire may only overrule when sure that the Line Umpire made a clear mistake.*

X. EXHIBITS

Case 6: *Is a Line Umpire allowed to change the call after the Chair Umpire has announced the score?*

Decision: *Yes. If a Line Umpire realizes a mistake, a correction should be made as soon as possible provided it is not as the result of a protest or appeal of a player.*

Case 7: *If a Chair Umpire or Line Umpire calls "out" and then corrects the call to good, what is the correct decision?*

Decision: *The Chair Umpire must decide if the original "out" call was a hindrance to either player. If it was a hindrance, the point shall be replayed. If it was not a hindrance, the player who hit the ball wins the point.*

Case 8: *A ball is blown back over the net and the player correctly reaches over the net to try to play the ball. The opponent(s) hinders the player from doing this. What is the correct decision?*

Decision: *The Chair Umpire must decide if the hindrance was deliberate or unintentional and either awards the point to the hindered player or order the point to be replayed.*

BALL MARK INSPECTION PROCEDURES

1. Ball mark inspections can only be made on clay courts.
2. A ball mark inspection requested by a player (team) shall be allowed only if the Chair Umpire cannot determine the call with certainty from their chair on either a point-ending shot or when a player (team) stops playing the point during a rally (returns are permitted but then the player must immediately stop).
3. When the Chair Umpire has decided to make a ball mark inspection, they should go down from the chair and make the inspection themselves. If they do not know where the mark is, they can ask the Line Umpire for help in locating the mark, but then the Chair Umpire shall inspect it.
4. The original call or overrule will always stand if the Line Umpire and Chair Umpire cannot determine the location of the mark or if the mark is unreadable.
5. Once the Chair Umpire has identified and ruled on a ball mark, this decision is final and not appealable.
6. In clay court tennis the Chair Umpire should not be too quick to announce the score unless absolutely certain of the call. If in doubt, wait before calling the score to determine whether a ball mark inspection is necessary.
7. In doubles the appealing player must make their appeal in such a way that either play stops or the Chair Umpire stops play. If an appeal is made to the Chair Umpire then they must first determine that the correct appeal procedure was followed. If it was not correct or if it was late, then the Chair Umpire may determine that the opposing team was deliberately hindered.
8. If a player erases the ball mark before the Chair Umpire has made a final decision, they concedes the call.
9. A player may not cross the net to check a ball mark without being subject to the Unsportsmanlike provision of the Code of Conduct.

X. EXHIBITS

ELECTRONIC REVIEW PROCEDURES

At tournaments where an Electronic Review System is used, the following procedures should be followed for matches on courts where it is used.

1. A request for an Electronic Review of a line call or overrule by a player (team) shall be allowed only on either a point-ending shot or when a player (team) stops playing the point during a rally (returns are permitted but then the player must immediately stop).
2. The Chair Umpire should decide to use the Electronic Review when there is doubt about the accuracy of the line call or overrule. However, the Chair Umpire may refuse the Electronic Review if they believe that the player is making an unreasonable request or that it was not made in a timely manner.
3. In doubles the appealing player must make their appeal in such a way that either play stops or the Chair Umpire stops play. If an appeal is made to the Chair Umpire then they must first determine that the correct appeal procedure was followed. If it was not correct or if it was late, then the Chair Umpire may determine that the opposing team was deliberately hindered, in which case the appealing team loses the point.
4. The original call or overrule will always stand if the Electronic Review is unable, for whatever reason, to make a decision on that line call or overrule.
5. The Chair Umpire's final decision will be the outcome of the Electronic Review and is not appealable. If a manual choice is required for the system to review a particular ball impact, a Review Official approved by the Referee shall decide which ball impact is reviewed.
6. Each player (team) is allowed three (3) unsuccessful appeals per set, plus one (1) additional appeal in the tie-break. For matches with advantage sets, players (teams) will start again with a maximum of three (3) unsuccessful appeals at 6 games all and every 12 games thereafter. For matches with match tie-break, the match tie-break counts as a new set and each player (team) starts with three (3) appeals. Players (teams) will have an unlimited number of successful appeals.

X. EXHIBITS

APPENDIX VII

10 AND UNDER TENNIS COMPETITION

Courts:

In addition to the (full sized) court described in Rule 1, the following court dimensions may be used for 10 and under tennis competition:

- A court, designated "Red" for the purposes of 10 and under tennis competition, shall be a rectangle, between 36 feet (10.97 m) and 42 feet (12.80 m) long, and between 14 feet (4.27 m) and 20 feet (6.10 m) wide. The net shall be between 31.5 inches (0.800 m) and 33.0 inches (0.838m) high at the center.
- A court, designated "Orange", shall be a rectangle, between 58 feet (17.68 m) and 60 feet (18.29 m) long, and between 20 feet (6.10 m) and 27 feet (8.23 m) wide. The net shall be between 31.5 inches (0.800 m) and 36.0 inches (0.914m) high at the center.

Balls:

Only the following ball types, which are specified in Appendix I, can be used in 10 and under tennis competition:

- A Stage 3 (Red) ball, which is recommended for play on a "red" court, by players aged up to 8 years, using a racket up to 23 inches (58.4 cm) long.
- A Stage 2 (Orange) ball, which is recommended for play on an "orange" court, by players aged 8 to 10 years, using a racket between 23 inches (58.4 cm) and 25 inches (63.5 cm) long.
- A Stage 1 (Green) ball, which is recommended for play on a full sized court, by advanced players aged 9 to 10 years, using a racket between 25 inches (63.5 cm) and 26 inches (66.0 cm) long.

Note: Other ball types described in Appendix I cannot be used in 10 and under tennis competition.

Scoring methods:

For 10 and under tennis competition using Stage 3 (Red), Stage 2 (Orange) or Stage 1 (Green) balls, scoring methods specified in the Rules of Tennis (including those specified in Appendix V) can be utilised, in addition to short duration scoring methods involving matches of one match tie-break, best of 3 tie-breaks/match tie-breaks, one short set or one regular set.

Timed matches:

For 10 and under tennis competition the tournament committee may set a specific time period for matches in the event.

X. EXHIBITS

APPENDIX VIII

PLAN OF THE COURTS

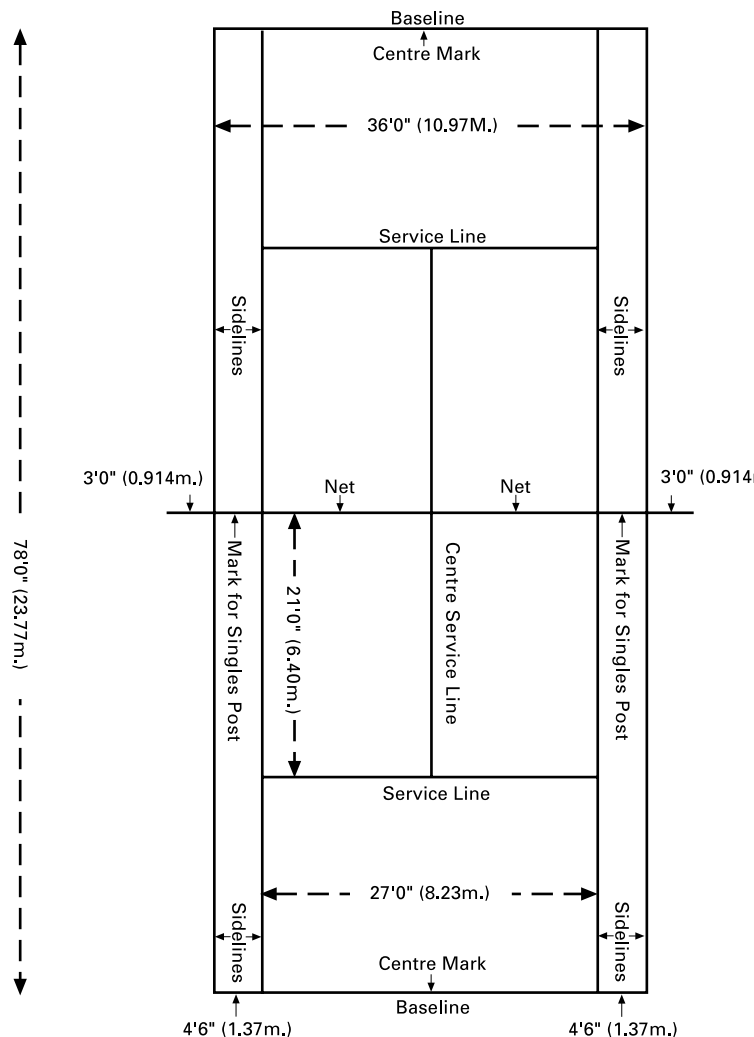

NOTE: All court measurements shall be made to the outside of the lines.

X. EXHIBITS

APPENDIX IX

SUGGESTIONS ON HOW TO MARK OUT A COURT

Including Blended Lines

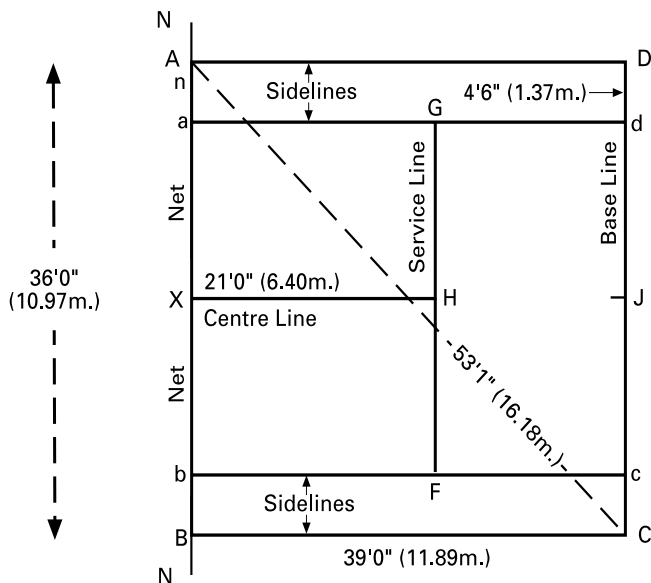

NOTE: All court measurements shall be made to the outside of the lines.

The following procedure is for the usual combined doubles and singles court. (See note at foot for a court for one purpose only.)

First select the position of the net; a straight line 42 feet (12.80 m) long. Mark the center (X on the diagram above) and, measuring from there in each direction, mark:

at 13'6" (4.11 m) the points a, b, where the net crosses the inner sidelines,

at 16'6" (5.03 m) the positions of the singles sticks (n, n),

at 18'0" (5.48 m) the points A, B, where the net crosses the outer sidelines,

at 21'0" (6.40 m) the positions of the net posts (N, N), being the ends of the original 42'0" (12.80 m) line.

Insert pegs at A and B and attach to them the respective ends of two measuring tapes. On one, which will measure the diagonal of the half-court, take a length 53'1" (16.18 m) and on the other (to measure the sideline) a length of 39'0" (11.89 m). Pull

X. EXHIBITS

both taut so that at these distances they meet at a point C, which is one corner of the court. Reverse the measurements to find the other corner D. As a check on this operation it is advisable at this stage to verify the length of the line CD which, being the baseline, should be found to be 36'0" (10.97 m); and at the same time its center J can be marked, and also the ends of the inner sidelines (c, d), 4'6" (1.37 m) from C and D.

The center line and service line are now marked by means of the points F, H, G, which are measured 21'0" (6.40 m) from the net down the lines bc, XJ, ad, respectively.

Identical procedure the other side of the net completes the court.

If a singles court only is required, no lines are necessary outside the points a, b, c, d, but the court can be measured out as above. Alternatively, the corners of the baseline (c, d) can be found if preferred by pegging the two tapes at a and b instead of at A and B, and by then using lengths of 47'5" (14.46 m) and 39'0" (11.89 m). The net posts will be at n, n, and a 33'0" (10 m) singles net should be used.

When a combined doubles and singles court with a doubles net is used for singles, the net must be supported at the points n, n, to a height of 3 feet 6 inches (1.07 m) by means of two singles sticks, which shall be not more than 3 inches (7.5 cm) square or 3 inches (7.5 cm) in diameter. The centers of the singles sticks shall be 3 feet (.914 m) outside the singles court on each side.

To assist in the placing of these singles sticks it is desirable that the points n, n, should each be shown with a white dot when the court is marked.

When sanctioning bodies approve so called "Blended Lines" on courts the following guidelines must be followed:

Colour:

- Within the same colour family as the background playing surface.
- Lighter than the background playing surface.
- Limit on colour variation of +22 points on the L* scale
(Add <25% by volume of white paint to the background colour)

Pace:

- Within 5 CPR of the playing surface.

Dimensions:

- 1.0-1.5 cm narrower than the standard lines.

Marking:

- Terminate 8 cm from intersection with white playing lines.

Note:

As a guide for international competitions, the recommended minimum distance between the baselines and the backstops should be 21 feet (6.40 m) and between the sidelines and the sidestops the recommended minimum distance should be 12

X. EXHIBITS

feet (3.66 m).

As a guide for recreational and Club play, the recommended minimum distance between the baselines and the backstops should be 18 feet (5.48 m) and between the sidelines and the sidestops the recommended minimum distance should be 10 feet (3.05 m).

As a guide, the recommended minimum height measured at the net from the court surface to the ceiling should be 30 feet (9.14 m)..

APPENDIX X

RULES OF BEACH TENNIS

The Rules of Beach Tennis are approved by the Rules of Tennis Committee and the Board of Directors and can be found on <https://www.itftennis.com/en/itf-tours/beach-tennis-tour/>

APPENDIX XI

PROCEDURES FOR REVIEW AND HEARINGS ON THE RULES OF TENNIS

1. INTRODUCTION

- 1.1 These procedures were approved by the Board of Directors of the International Tennis Federation (“Board of Directors”) on 17 May 1998.
- 1.2 The Board of Directors may from time to time supplement, amend, or vary these procedures.

2. OBJECTIVES

- 2.1 The International Tennis Federation is the custodian of the Rules of Tennis and is committed to:
 - a. Preserving the traditional character and integrity of the game of tennis.
 - b. Actively preserving the skills traditionally required to play the game.
 - c. Encouraging improvements, which maintain the challenge of the game.
 - d. Ensuring fair competition.
- 2.2 To ensure fair, consistent and expeditious review and hearings in relation to the Rules of Tennis the procedures set out below shall apply.

3. SCOPE

- 3.1 These Procedures shall apply to Rulings under:
 - a. Rule 1 – The Court.
 - b. Rule 3 – The Ball.
 - c. Rule 4 – The Racket.
 - d. Appendix I and II of the Rules of Tennis.
 - e. Any other Rules of Tennis which the International Tennis Federation may decide.

X. EXHIBITS

4. STRUCTURE

- 4.1 Under these procedures Rulings shall be issued by a Ruling Board.
- 4.2 Such Rulings shall be final save, for an entitlement to appeal to an Appeal Tribunal pursuant to these procedures.

5. APPLICATION

- 5.1 Rulings shall be taken either:
 - a. Following a motion of the Board of Directors; or
 - b. Upon the receipt of an application in accordance with the procedures set out below.

6. APPOINTMENT AND COMPOSITION OF RULING BOARDS

- 6.1 Ruling Boards shall be appointed by the President of the International Tennis Federation (“President”) or their designee and shall comprise of such a number, as the President or their designee shall determine.
- 6.2 If more than one person is appointed to the Ruling Board the Ruling Board shall nominate one person from amongst themselves to act as Chairperson.
- 6.3 The Chairperson shall be entitled to regulate the procedures prior to and at any review and/or hearing of a Ruling Board.

7. PROPOSED RULINGS BY THE RULING BOARD

- 7.1 The details of any proposed Ruling issued upon the motion of the Board of Directors may be provided to any bona fide person or any players, equipment manufacturer or national association or members thereof with an interest in the proposed Ruling.
- 7.2 Any person so notified shall be given a reasonable period within which to forward comments, objections, or requests for information to the President or his designee in connection with the proposed Ruling.

8. APPLICATION FOR RULINGS

- 8.1 An application for a Ruling may be made by any party with a bona fide interest in the Ruling including any player, equipment manufacturer or national association or member thereof.
- 8.2 Any application for a Ruling must be submitted in writing to the President.
- 8.3 To be valid an application for a Ruling must include the following minimum information:
 - a. The full name and address of the Applicant.
 - b. The date of the application.
 - c. A statement clearly identifying the interest of the Applicant in the question upon which a Ruling is requested.
 - d. All relevant documentary evidence upon which the Applicant intends to rely at any hearing.
 - e. If, in the opinion of the Applicant, expert evidence is necessary they shall include a request for such expert evidence to be heard. Such request must identify the name of any expert proposed and their relevant expertise.

X. EXHIBITS

- f. When an application for a Ruling on a racket or other piece of equipment is made, a prototype or, exact, copy of the equipment in question must be submitted with the application for a Ruling.
- g. If, in the opinion of the Applicant, there are extraordinary or unusual circumstances, which require a Ruling to be made within a specified time or before a specified date they shall include a statement describing the extraordinary or unusual circumstances.

8.4 If an application for a Ruling does not contain the information and/or equipment referred to at Clause 8. 3 (a)-(g) above the President or their designee shall notify the Applicant giving the Applicant a specified reasonable time within which to remedy the defect. If the Applicant fails to remedy the defect within the specified time the application shall be dismissed.

9. CONVENING THE RULING BOARD

- 9.1** On receipt of a valid application or on the motion of the Board of Directors the President or their designee may convene a Ruling Board to deal with the application or motion.
- 9.2** The Ruling Board need not hold a hearing to deal with an application or motion where the application or motion, in the opinion of the Chairperson can be resolved in a fair manner without a hearing.

10. PROCEDURE OF THE RULING BOARD

- 10.1** The Chairperson of a Ruling Board shall determine the appropriate form, procedure and date of any review and/or hearing.
- 10.2** The Chairperson shall provide written notice of those matters set out at 10.1 above to any Applicant or any person or association who has expressed an interest in the proposed Ruling.
- 10.3** The Chairperson shall determine all matters relating to evidence and shall not be bound by judicial rules governing procedure and admissibility of evidence provided that the review and/or hearing is conducted in a fair manner with a reasonable opportunity for the relevant parties to present their case.
- 10.4** Under these procedures any review and/or hearings:
 - a. Shall take place in private.
 - b. May be adjourned and/or postponed by the Ruling Board.
- 10.5** The Chairperson shall have the discretion to co-opt from time to time additional members onto the Ruling Board with special skill or experience to deal with specific issues, which require such special skill or experience.
- 10.6** The Ruling Board shall take its decision by a simple majority. No member of the Ruling Board may abstain.
- 10.7** The Chairperson shall have the complete discretion to make such order against the Applicant [and/or other individuals or organizations commenting objecting or requesting information at any review and/or hearing] in relation to the costs of the application and/or the reasonable expenses incurred by the Ruling Board in holding tests or obtaining reports relating to equipment subject to a Ruling as he shall deem appropriate.

X. EXHIBITS

11. NOTIFICATION

- 11.1** Once a Ruling Board has reached a decision it shall provide written notice to the Applicant, or, any person or association who has expressed an interest in the proposed Ruling as soon as reasonably practicable.
- 11.2** Such written notice shall include a summary of the reasoning behind the decision of the Ruling Board.
- 11.3** Upon notification to the Applicant or upon such other date specified by the Ruling Board the Ruling of the Ruling Board shall be immediately binding under the Rules of Tennis.

12. APPLICATION OF CURRENT RULES OF TENNIS

- 12.1** Subject to the power of the Ruling Board to issue interim Rulings the current Rules of Tennis shall continue to apply until any review and/or hearing of the Ruling Board is concluded and a Ruling issued by the Ruling Board.
- 12.2** Prior to and during any review and/or hearing the Chairperson of the Ruling Board may issue such directions as are deemed reasonably necessary in the implementation of the Rules of Tennis and of these procedures including the issue of interim Rulings.
- 12.3** Such interim Rulings may include restraining orders on the use of any equipment under the Rules of Tennis pending a Ruling by the Ruling Board as to whether or not the equipment meets the specification of the Rules of Tennis.

13. APPOINTMENT AND COMPOSITION OF APPEAL TRIBUNALS

- 13.1** Appeal Tribunals shall be appointed by the President or their designee from [members of the Board of Directors/Technical Commission].
- 13.2** No member of the Ruling Board who made the original Ruling shall be a member of the Appeal Tribunal.
- 13.3** The Appeal Tribunal shall comprise of such number as the President or his designee shall determine but shall be no less than three.
- 13.4** The Appeal Tribunal shall nominate one person from amongst themselves to act as Chairperson.
- 13.5** The Chairperson shall be entitled to regulate the procedures prior to and at any appeal hearing.

14. APPLICATION TO APPEAL

- 14.1** An Applicant [or a person or association who has expressed an interest and forwarded any comments, objections, or requests to a proposed Ruling] may appeal any Ruling of the Ruling Board.
- 14.2** To be valid an application for an appeal must be:
 - a. Made in writing to the Chairperson of the Ruling Board who made the Ruling appealed not later than 45 days following notification of the Ruling;
 - b. Must set out details of the Ruling appealed against; and
 - c. Must contain the full grounds of the appeal.
- 14.3** Upon receipt of a valid application to appeal the Chairperson of the Ruling Board making the original Ruling may require a reasonable appeal fee to be paid by the

X. EXHIBITS

Appellant as a condition of appeal. Such appeal fee shall be repaid to the Appellant if the appeal is successful.

15. CONVENING THE APPEAL TRIBUNAL

- 15.1** The President or their designee shall convene the Appeal Tribunal following payment by the Appellant of any appeal fee.

16. PROCEDURES OF APPEAL TRIBUNAL

- 16.1** The Appeal Tribunal and their Chairperson shall conduct procedures and hearings in accordance with those matters set out in sections 10, 11 and 12 above.
- 16.2** Upon notification to the Appellant or upon such other date specified by the Appeal Tribunal the Ruling of the Appeal Tribunal shall be immediately binding and final under the Rules of Tennis.

17. GENERAL

- 17.1** If a Ruling Board consists of only one member that single member shall be responsible for regulating the hearing as Chairperson and shall determine the procedures to be followed prior to and during any review and/or hearing.
- 17.2** All review and/or hearings shall be conducted in English. In any hearing where an Applicant, and/or other individuals or organizations commenting, objecting or requesting information do not speak English an interpreter must be present. Wherever practicable the interpreter shall be independent.
- 17.3** The Ruling Board or Appeal Tribunal may publish extracts from its own Rulings.
- 17.4** All notifications to be made pursuant to these procedures shall be in writing.
- 17.5** Any notifications made pursuant to these procedures shall be deemed notified upon the date that they were communicated, sent or transmitted to the Applicant or other relevant party.
- 17.6** A Ruling Board shall have the discretion to dismiss an application if in its reasonable opinion the application is substantially similar to an application or motion upon which a Ruling Board has made a decision and/or Ruling within the 36 months prior to the date of the application.

© ITF Limited t/a International Tennis Federation
All rights reserved
2020

X. EXHIBITS

EXHIBIT J - Prize Money ATP Tour and ATP Challenger Tour

Please refer to Detail Sheet for approved prize money breakdowns.

X. EXHIBITS

EXHIBIT K - Glossary

Draw Results:

The Supervisor must record match results using, where appropriate, the following definitions:

Abandoned: Match began but was not completed for any reason other than default or retirement. There is no winner or loser. The match is not to be completed. Players receive points and money equivalent to loser of that round.

Default: Losing player was defaulted under provisions of Code of Conduct after match had begun.

Incomplete: Match began but was not completed for any reason other than weather, default, or retirement. There is no winner or loser. It is anticipated that the match will be resumed and completed.

Ineligible: Player fails to sign the Consent and Agreement form prior to his first match.

Retired: Losing player retired because of illness or injury after match had begun.

Unplayed: Match did not begin for any reason other than (a) illness or injury on the part of one player or (b) one player was subjected to penalties of Code of Conduct before first serve of match was struck or otherwise not permitted by ATP or tournament Supervisor from playing. There is no winner or loser and the match will not be played.

Unregistered: Player fails to complete the registration process prior to his first match.

Walkover: Match did not begin because:

- a) losing player was ill or injured or
- b) losing player was subjected to penalties of Code of Conduct before first serve of match was struck or otherwise not permitted by ATP or tournament Supervisor to play.
This would not be used when a lucky loser or alternate is substituted. Winners of "walkover"/"no match" matches receive points and prize money as if the match had been played.

Weather: Match began but was not completed because of inclement weather. There is no winner or loser. It is anticipated that the match will be resumed and completed.

Miscellaneous Definition of Terms

Alternate: The next highest ranked player(s) who were not a direct acceptance at the time of the entry deadline.

ATP Player Dues: Money owed or collected for ATP player membership or the annual dues of such membership.

ATP Standards Committee: A committee approved by the ATP Board with certain powers to oversee creation and compliance of ATP tournament standards.

Ball Mark Inspection (BMI): On clay courts the Chair Umpire may leave the chair and inspect the mark left by the ball in play to determine the correctness of the

X. EXHIBITS

call. This can only be done after a point-ending shot or if the player or team stops play to request an inspection.

Ceremonies: Awards presentations customarily held following the conclusion of the final championship match(es).

Chair Umpire: This official is responsible for the conduct of the match. His main duties are to enforce all ATP Rules and Regulations and on-court procedures to ensure accuracy, fairness and safety. He is the final authority on all questions of fact that may arise during the match.

Direct Acceptance: Players or teams accepted directly in the draw by virtue of their position in the Pepperstone ATP Rankings or Pepperstone ATP Doubles Rankings System or by their protected ranking.

Pepperstone ATP Rankings (Singles & Doubles): The objective merit-based method used for determining qualification for entry and seeding in all tournaments for both singles and doubles and the Nitto ATP Finals (singles & doubles).

Ineligible: Player fails to sign the Consent and Agreement Form prior to his first match.

Late Withdrawal: Player withdraws after 10 AM PVB time on the Friday prior to the event; or player does not appear for his match and is not on-site.

Late Withdrawal (Dbl-MD) – used to indicate a player who has withdrawn from doubles after the on-site entry deadline.

Late Withdrawal, Qualifying: This applies to ATP Tour Masters 1000 and ATP Tour 500 events where there is an advance acceptance list for the qualifying and the player withdraws after the deadline.

Line Umpire: Officials responsible for calling specific assigned lines according to the ATP Rules under the direct on-court supervision of the Chair Umpire.

Lucky Loser: Players who have lost in the final round of qualifying, or if needed, earlier rounds. These players are placed in rank order and may become eligible to replace any player in the main draw who is forced to withdraw prior to his first match.

Major Offenses: aggravated behavior, Bribes or Other Payments, Conduct Contrary to the Integrity of the Game, Prohibited Promotional Fees and Wagers. A Major Offense is initiated and investigated by the Senior Vice President - Rules & Competition and is in addition to any penalties that may have been levied by the on-site Supervisor.

Medical Time-Out (MTO): Official time allotted during the match for treatment due to an approved medical condition. The treatment is given by the ATP Physiotherapist. The time allowed is 3 minutes (4 1/2 if taken on a changeover) for each separate medical condition.

No Match: There was not an eligible alternate available.

No Show: Player does not appear for his first match and there has been no contact or prior notification from the player that he would not appear for the match. For penalty purposes, this would be penalized as a "Late Withdrawal".

Non-Member Service Fee: Players who are not members in good standing of ATP must pay a fee for services rendered. This applies to main draw players at all ATP Tour Masters 1000 or ATP Tour 500 and ATP Tour 250 events and to qual-

X. EXHIBITS

ifying players at ATP Tour Masters 1000, ATP Tour 500 events and ATP Tour 250 events. This does not apply to the Challenger Circuit.

On-Site Withdrawal (ATP Tour): Player withdraws after 10 AM Eastern time, USA on Friday and was on-site at the event when the withdrawal occurred and is determined to be unfit for play by that tournament's Doctor. Players still competing in a tournament or Davis Cup match after the 10 AM deadline and are forced to withdraw/retire, from a match may be examined by that event's Doctor and shall then be considered the same as an On-Site Withdrawal. Withdrawals/Retirements from Davis Cup must be from "live" matches and include a medical certification from the Independent Doctor. This should be documented on the withdrawal summary from the tournament that the player withdrew from.

On-Site Withdrawal (ATP Challenger or ATP Tour Qualifying): Player withdraws after the 10 AM Friday deadline and is examined at the tournament site within the first three (3) days of the event, or in the case of ATP Tour qualifying on the Saturday or Sunday of qualifying. Players still competing in a tournament or Davis Cup match after the 10 AM deadline and are forced to withdraw/retire, from a match may be examined by that event's Doctor and shall then be considered the same as an On-Site Withdrawal. Withdrawals/Retirements from Davis Cup must be from "live" matches and include a medical certification from the Independent Doctor. This should be documented on the withdrawal summary from the tournament that the player withdrew from.

Protected Ranking: A ranking assigned a player who has been unable, due to injury, to compete in any tennis event for a minimum of six (6) months.

Punctuality: Player fails to appear, in a timely manner, when his match has been called. Provisions for Non-Appearance do not apply.

Qualifier: Player who has won his place into the main draw by way of a qualifying competition.

Qualifying Non-Appearance: A player is entered into the qualifying through the Supervisor of another event and does not appear for his match. This also includes players accepted into the qualifying as a wild card who do not appear for their match. This includes those who sign-in through the Supervisor as an alternate to ATP Tour qualifying. It also covers ATP Challenger Tour events.

Referee: Official hired by the tournament to advise in planning the event and assist the ATP Supervisor in his assigned duties and responsibilities.

Review Official: Official hired by ATP who is responsible for the Review function of Electronic Line Calling systems on-site.

Seed: Players who are given preferential positions in the draw based on the Pepperstone ATP Rankings System.

Special Event: Those events other than Grand Slams, ATP Tour tournaments or ATP Challenger Tour tournaments.

Special Exempt: Player accepted into the main draw who was still competing in the singles event of another qualified event at the time of this event's qualifying. Player may not have been accepted as a direct acceptance, if entered.

Special Exempt /Wild Card Non-Appearance: A player accepts a SE or WC and does not appear for his match and is not on-site. This violation would be considered as a Late Withdrawal and be subject to the penalties set forth under

X. EXHIBITS

Late Withdrawal.

Supervisor: Final on-site authority ensuring that the tournament is conducted fairly in accordance with ATP's Rules and Regulations as to all matters arising that require immediate resolution.

Tour Manager: Represents the player's interests in all matters involving the sign-ins, draws and the scheduling of the event.

Tournament Director: Person representing the owners of the event in the day-to-day management of the tournament.

Tournament Week: Commences on a Monday and concluding on a Sunday, unless otherwise approved by ATP. Tournaments with a published Saturday final shall have the tournament week conclude on Saturday.

Unregistered - Player fails to complete the registration process prior to his first match.

Wild Card: Players included in the draw at the sole discretion of the tournament. A specified number of wild cards are available in each event.

Withdrawal: Player who withdraws after the entry deadline but prior to 10 AM (PVB) on the Friday prior to the event.

- **Withdrawal (Db1)** - used to indicate a doubles withdrawal that is after the 10 AM Friday withdrawal deadline and prior to the on-site sign-in deadline
- **Withdrawal (Db1)/On-Site Medical** – used to indicate a player who has withdrawn from doubles where both members were on site at the time of the withdrawal and the withdrawal was due to a medical condition

X. EXHIBITS

EXHIBIT L - Chief of Umpires

The Chief of Umpires shall:

- 1) **Be prepared to brief the Supervisor and Referee on:**
 - a) The plan for implementing the officials.
- 2) **Discharge the following responsibilities:**
 - a) Pre-tournament.
 - i) Recruit a sufficient number of competent officials who are qualified to officiate at this level of event. The most qualified officials must be assigned through the finals. Prepare a list of officials (Line Umpires with ratings, Chair Umpires with ratings) for the full-time ATP official coordinating the officials for the event.
 - ii) If applicable, negotiate a contract or agreement for officials with the tournament.
 - iii) If a Challenger event, submit to ATP a list of proposed Designated Chair Umpires no less than 90 days prior to the start of the tournament.
 - iv) If requested by the tournament, provide a list of officials to the Chairperson responsible for the program.
 - v) Compile an officials' clothing sizes list, in case the tournament furnishes clothing for uniforms.
 - vi) Conduct the necessary pre-tournament training of officials including review of the Rules of Tennis, ATP tournament Rules and Code.
 - vii) Check with the tournament about arrangements for:
 - o umpire chairs
 - o cushions//sunshades
 - o singles sticks
 - o chairs for use on--court by Line Umpires
 - o scorecards
 - o scoreboards//personnel
 - o new and used balls
 - viii) Check supplies for the tournament:
 - o scorecards
 - o clipboards (if needed)
 - o point penalty forms
 - o first aid kit
 - o pencils
 - o office supplies
 - o crew rotation forms
 - o on-court Line Umpire evaluation forms
 - Note:** Rotation information is available upon request from ATP.
 - ix) Check all applicable arrangements for officials:
 - o on--site office and lounge
 - o transportation (long-distance or local)
 - o food and beverages
 - o parking
 - o telephones
 - o housing
 - o security
 - o toilets
 - o photocopier
 - o walkie--talkies
 - x) Prepare a check-in form if the number of officials requires it.
 - xi) Organize a method of notification or a mailing that informs all of the officials about the tournament dates, officials report times (no less than 30 minutes before start of play), uniform requirements and arrangements for transportation, parking and housing. An umpire information sheet is recommended for an event larger than a 32 draw.
 - xii) Present to the ATP Supervisor at least 2 weeks prior to the qualifying sign-in:
 - o an availability list of the Chair Umpires for each day including both

X. EXHIBITS

- the designated and additional Chair Umpires. Categorize according to rating, experience and ability.
 - b) During the Tournament:
 - i) Provide assistance to the ATP Supervisor as needed.
 - ii) Be on-site at all times during play. The Chief of Umpires may not be a Chair Umpire or Line Umpire unless authorized by the ATP Supervisor.
 - iii) Instruct the officials on the tournament procedure for handling new and used balls.

Note that it is inappropriate for the Chair Umpires to supply the court with the balls for their matches.
 - iv) Instruct the officials on the procedure for reporting and turning in point penalty forms.
 - v) Schedule the on-court assignment of the Line Umpires, subject to the approval of the ATP Supervisor, Line Umpires for the quarterfinals, semi-finals and finals must have worked a minimum of two (2) days prior to the quarterfinal and must have demonstrated that their skills merit the assignment.
 - c) Observe the performance of all officials during the matches.
 - d) Remove, rotate or replace a Line Umpire whenever it is necessary to improve the officiating of a match.
 - e) Maintain the ATP Line Umpire evaluation process, and make ongoing assignments based upon evaluations.
 - i) Be prepared for other contingencies (such as rain) that may change the number of courts being used.
 - ii) Prepare a day in advance, recording Chair Umpire assignments on the order of play and preparing rotations for the line teams.

Complete information must be posted before the arrival of the officials the next day, no less than 30 minutes before the start of play.
 - iii) Conduct a daily meeting with all officials.
 - f) Post-Tournament.

Prepare a written report for the Supervisor. Include recommendations for improvements and the prevention of problems.

X. EXHIBITS

EXHIBIT M - Special Exempts - ATP 250 to ATP 500 Events

Special Exempt from ATP Tour 250 – list of events.

500 Event	SE Eligible from 250		
Rotterdam	Montpellier		
Rio de Janeiro	Buenos Aires	Dallas	
Acapulco	Delray Beach		
Dubai	Marseille		
Barcelona	None		
Halle	's-Hertogenbosch	Stuttgart	
London Queens	's-Hertogenbosch	Stuttgart	
Washington D.C.	Atlanta		
Beijing	Chengdu	Zhuhai	
Tokyo	Chengdu	Zhuhai	
Basel	Antwerp	Moscow	Stockholm
Vienna	Antwerp	Moscow	Stockholm

X. EXHIBITS

EXHIBIT N - Special Exempts - ATP Challenger Tour

For the purpose of the ATP Challenger Tour special exempt rule, a geographic region is defined as follows:

Region I -

Americas.

This region includes the following countries:

North America -

Canada, United States (including Hawaii) and Mexico

Central America and the Caribbean -

Anguilla (UK), Antigua and Barbuda, Aruba (Neth.), Bahamas, Barbados, Belize, Bermuda (UK), British Virgin Islands (UK), Cayman Islands (UK), Costa Rica, Cuba, Dominica, Dominican Republic, El Salvador, Greenland (Den.), Grenada, Guadeloupe (Fr.), Guatemala, Guyana, Haiti, Honduras, Jamaica, Martinique (Fr.), Montserrat (UK), Netherlands Antilles (Neth.), Nicaragua, Panama, Puerto Rico (U.S.), St. Kitts and Nevis, St. Lucia, St.-Pierre and Miquelon (Fr.), St. Vincent and the Grenadines, Trinidad and Tobago, Turks and Caicos Islands (UK), Virgin Islands (U.S.).

South America -

Argentina, Bolivia, Brazil, Chile, Colombia, Ecuador, Falkland Islands (UK), French Guiana (Fr.), Paraguay, Peru, Suriname, Uruguay, Venezuela.

Region II -

Europe, Africa, Middle East, Western part of Russia and some Western Asia countries.

This region includes the following countries:

Europe -

Albania, Andorra, Austria, Belarus, Belgium, Bosnia-Herzegovina, Bulgaria, Channel Islands (UK), Croatia, Czech Republic, Denmark, Estonia, Finland, France, Germany, Gibraltar (UK), Greece, Hungary, Iceland, Ireland, Italy, Latvia, Liechtenstein, Lithuania, Luxembourg, Malta, Moldova, Monaco, Montenegro, Netherlands, F.Y.R. of Macedonia, Norway, Poland, Portugal, Romania, San Marino, Serbia, Slovakia, Slovenia, Spain, Sweden, Switzerland, Ukraine, United Kingdom, Vatican City.

Africa -

Algeria, Angola, Azores (Port.), Benin, Botswana, Burkina Faso, Burundi, Cameroon, Canary Islands (Sp.), Cape Verde, Central African Republic, Chad, Comoros, Congo, Côte d'Ivoire, Democratic Republic of the Congo, Djibouti, Egypt, Equatorial Guinea, Eritrea, Ethiopia, Gabon, Gambia, Ghana, Guinea, Guin-

X. EXHIBITS

ea-Bissau, Kenya, Lesotho, Liberia, Libya, Madagascar, Madeira (Port.), Malawi, Mali, Mauritania, Mauritius, Mayotte (Fr.), Morocco, Mozambique, Namibia, Niger, Nigeria, Reunion (Fr.), Rwanda, Sao Tome and Principe, Senegal, Seychelles, Sierra Leone, Somalia, South Africa, Sudan, Swaziland, Tanzania, Togo, Tunisia, Uganda, Western Sahara, Zambia, Zimbabwe.

Middle East -

Armenia, Azerbaijan, Bahrain, Cyprus, Gaza Strip (Israeli-occupied terr.), Georgia, Iran, Iraq, Israel, Jordan, Kuwait, Lebanon, Oman, Qatar, Saudi Arabia, Syria, Turkey, United Arab Emirates, West Bank (Israeli-occupied terr.), Yemen.

Western Asia -

Afghanistan, Kazakhstan, Kyrgyzstan, Pakistan, Tajikistan, Turkmenistan and Uzbekistan.

Western Russia -

Includes Moscow, St. Petersburg and Togliatti.

Region III -

Eastern part of Asia and Oceania -

This region includes the following countries:

Eastern Asia -

Bangladesh, Bhutan, Brunei, Cambodia, China, Chinese Taipei, Guam (U.S.), India, Indonesia, Japan, Republic of Korea, Democratic People's Republic of Korea, Laos, Malaysia, Maldives, Mongolia, Myanmar, Nepal, Northern Mariana Islands (U.S.), Palau, Philippines, Eastern Russia, Singapore, Sri Lanka, Thailand, Vietnam.

Oceania -

American Samoa (U.S.), Australia, Cook Islands (N.Z.), Fiji, French Polynesia (Fr.), Kiribati, Marshall Islands, Micronesia, Nauru, New Caledonia (Fr.), New Zealand, Niue (N.Z.), Papua New Guinea, Pitcairn Islands (UK), Samoa, Solomon Islands, Tokelau (N.Z.), Tonga, Tuvalu, Vanuatu, Wallis and Futuna (Fr.).

X. EXHIBITS

EXHIBIT O - Consent and Agreement Form

PLAYER'S CONSENT AND AGREEMENT TO THE ATP OFFICIAL RULEBOOK, INCLUDING THE TENNIS ANTI-CORRUPTION PROGRAM & TENNIS ANTI-DOPING PROGRAMME

I, the undersigned player, acknowledge, consent and agree as follows:

1. I will comply with and be bound by all of the provisions of the 2023 ATP OFFICIAL RULEBOOK and the ATP Tour, Inc.'s ("ATP") By-Laws (the "ATP Rules"), including, but not limited to, all amendments to the ATP Rules. I have received and had an opportunity to review the ATP Rules and any and all Covid-19 policies and protocols, as amended from time to time.
2. I am bound by and will comply with the Tennis Anti-Corruption Program (the "TACP"), a copy of which can be found at the following website: <https://www.itia.tennis/tacp/rules>. I acknowledge that I have had the opportunity to review the TACP and that I understand, accept and agree not to violate any of the provisions therein. I acknowledge that I have a duty to inform my Related Persons (as defined in the TACP) of the provisions of the TACP and to instruct them to comply with the TACP. I accept that I must complete any Tennis Integrity education programs mandated by the ATP Tour. The TACP prohibits certain conduct by me and my Related Persons, including, but not limited to, (i) wagering on the outcome or any other aspect of any tennis match, (ii) contriving or attempting to contrive the outcome or any other aspect of any tennis match, (iii) receiving or providing consideration in exchange for Inside Information (as defined in the TACP), (iv) facilitating, encouraging or promoting any other person to wager on the outcome or any other aspect of a tennis match, (v) associating with any Related Person who is serving any period of ineligibility under the TACP or has been convicted or found in criminal, disciplinary or professional proceedings to have engaged in conduct which would have constituted a Corruption Offense if the TACP had applied to them and (vi) failing to report any knowledge I may have regarding potential violations of the TACP. I acknowledge that I have an obligation to report any approaches that I may receive and any known or suspected offenses by others as soon as possible. I accept that I must cooperate fully with investigations and shall not tamper with or destroy any evidence. I hereby submit to the jurisdiction and authority of the International Tennis Integrity Agency (the "ITIA") to manage, administer and enforce the TACP and to the jurisdiction and authority of the ITIA, Anti-Corruption Hearing Officer ("AHO") and the Court of Arbitration for Sport ("CAS"), as applicable, to determine any charges brought under the TACP. I acknowledge that the TACP contains an agreement to arbitrate disputes in accordance with the process described in the TACP and I am bound by the TACP until the earlier of (i) the date of my valid retirement in accordance with the requirements of the TADP, or (ii) two years after the last Event (as defined in the TACP) in which I enter or participate, unless, at either such time, (a) I am subject to a period of ineligibility under either the TACP or TADP (in which case I will cease to be bound by the TADP upon the conclusion of my period of ineligibility), or (b) I am aware that I am the subject of an investigation by the ITIA or law enforcement (in which case I will cease to be bound by the TACP when such investigation is closed, or after 10 years, whichever is earlier). Nothing in this paragraph 2 shall modify or limit the full text of the TACP.
3. The ITIA may conduct anti-doping testing at ATP sanctioned events under the Tennis Anti-Doping Programme (the "TADP"), a copy of which is available online at <https://>

X. EXHIBITS

www.itia.tennis/tadp/rules/. ATP will honor and enforce any penalties or sanctions against me resulting from the TADP. The TADP shall apply to and be binding upon me and shall govern participation in the events specified at Article B of the TADP, which includes all ATP-sanctioned events (including Challenger events). I hereby submit to the jurisdiction and authority of the ITIA to manage, administer and enforce the TADP on behalf of the ITF and to the jurisdiction and authority of the Anti-Doping Tribunal and the CAS to determine any charges brought under the TADP. I also hereby give my explicit consent to (i) ATP receiving and processing my Anti-Doping results from the ITIA at ATP events as well as other Covered Events (as defined in the TADP), including information relating to any alleged Whereabouts Failures (i.e. Missed Tests and/or Filing Failures) on my part, as well as notice of any charges brought against me under the TADP and (ii) keeping ATP informed thereafter of the progress of such alleged Whereabouts Failures/charges in accordance with the TADP.

4. Any dispute arising out of any decision made by the Anti-Doping Tribunal, or any dispute arising under or in connection with the TADP, after exhaustion of the TADP's Anti-Doping Tribunal process and any other proceedings expressly provided for in the TADP, shall be submitted exclusively to the Appeals Arbitration Division of the CAS for final and binding arbitration in accordance with Article O of the TADP and CAS's Code of Sports-Related Arbitration. The decisions of CAS shall be final, non-reviewable, non-appealable and enforceable. I agree that I will not bring any claim, arbitration, lawsuit or litigation in any other court or tribunal. The time limit for any submission to CAS shall be 21 days after the decision of the Anti-Doping Tribunal has been communicated to me.
5. Any dispute between or among the ATP and me arising out of the application of any provision of the 2023 ATP Official Rulebook which is not finally resolved by applicable provisions of such Rulebook shall be submitted exclusively to CAS for final and binding arbitration in accordance with CAS's Code of Sports-Related Arbitration. The decision of CAS in that arbitration shall be final, non-reviewable and enforceable. No claim, arbitration, lawsuit or litigation concerning the dispute shall be brought in any other court or tribunal. Any request for CAS arbitration shall be filed with CAS within 21 days of any action by the ATP which is the subject of the dispute. In the event any provision of this clause is determined invalid or unenforceable, the remaining provisions shall not be affected. This clause shall not fail because any part of the rule is held invalid.
6. I acknowledge the Notices of Privacy Practice is set forth in the ATP Rule Book and is available online at <https://www.atppz.com>. I understand that the GDPR (General Data Protection Regulation) Privacy Notice is available at this same site under PlayerZone Terms & Conditions. I also acknowledge that I have reviewed these notices and agree to the terms and conditions contained therein.
7. For ATP Division I and Division II player members: I acknowledge that at least every two years a completed Competition Clearance form signed by a physician licensed to practice medicine in the jurisdiction where such physician practices medicine, must be submitted before players are permitted to participate in ATP activities. I also acknowledge that should my physician not deem me fit to participate, and I choose to do so regardless, I will not be permitted to compete without signing the Release and Hold Harmless form. Finally, I explicitly consent to the release of my medical information included on the Competition Clearance form to authorized medical personnel

X. EXHIBITS

at any ATP tournament that I participate in, which may be required for treatment purposes.

8. I have read and understand the foregoing Player's Consent and Agreement.

_____	_____
Date	Print Player's Name (Last Name, First Name)
_____	_____
Player's Date of Birth (Day/Month/year)	Player's Signature and
_____	_____
Place of Birth	If player is a minor, signature of player's parent or guardian
_____	_____
	Player's Nationality

X. EXHIBITS

EXHIBIT P - Privacy Notice (“HIPPA”)

NOTICE OF PRIVACY PRACTICES AND CONSENT

This notice is being provided in connection with the Health Insurance Portability and Accountability Act of 1996 (“HIPAA”). Although ATP is not bound to comply with all aspects of HIPAA, ATP is committed to making sure that players are aware of the manner in which personal health information will be used, maintained and released.

THIS NOTICE DESCRIBES HOW THE ATP TOUR (the “ATP”; FOR THE PURPOSES OF THIS EXHIBIT, INCLUDED IN THE DEFINITION OF “ATP” SHALL BE NON-ATP EMPLOYED STAFF AT CHALLENGER TOURNAMENTS WHO PROVIDE MEDICAL ASSISTANCE) MAY USE AND DISCLOSE YOUR MEDICAL INFORMATION, AND HOW YOU CAN GAIN ACCESS TO YOUR PERSONAL AND PROTECTED HEALTH INFORMATION (“PHI”); PLEASE REVIEW CAREFULLY.

ATP is committed to maintaining the confidentiality of your PHI, in accordance with applicable federal and applicable state privacy laws, as well as our own company privacy policies. This notice describes how we may use and disclose your PHI and explains your legal rights regarding PHI. This notice also describes certain risks associated with Players and others utilizing a Physiotherapist Treatment Room or other facility.

When we use the term “PHI”, we mean information about you, including any health care payment, medical or demographic information that can reasonably be used to identify you and relates to your medical history. This includes, but is not limited to, injuries, illnesses, sickness, diseases, health care providers and laboratory and other test results.

This notice is effective on January 1, 2010. The terms of this notice apply to all records containing your PHI that are created or retained by ATP. We reserve the right to revise or amend this notice. Any revision or amendment to this notice will be effective for all of your records that ATP has created or maintained in the past, and for any of your records that ATP may create or maintain in the future. You will find this and any revised or amended notices posted at ATP’s offices in Ponte Vedra Beach, Florida in a visible location, as well as on the PlayerZone website located at: <https://atp-playerzone.com>.

HOW ATP MAY USE AND DISCLOSE YOUR PHI

In order to provide you with certain health and other services, we may create or receive PHI relating to you. In coordinating and administering services, we may use and disclose your PHI in various ways, including:

- 1) **Treatment.** ATP may use your PHI to assist in your treatment by providers. For example, a Physiotherapist or the medical director of a tournament may access your PHI to understand and better treat your condition.
- 2) **Health Care Operations.** We may use and disclose PHI during the course of managing our business. For example, we may use your PHI to internally evaluate the quality of care that you received, to conduct internal company audits, for

X. EXHIBITS

data information systems management, to conduct company cost management assessments, for evaluations and for general business planning purposes.

- 3) **Payment.** Your PHI may be requested by a third party for billing purposes, with regard to services provided to you, to conduct utilization and medical necessity reviews, to coordinate care with your health care insurance company or carrier, to calculate cost sharing amounts, and to respond to audits or reviews by federal or state government agencies, insurance companies or carriers.
- 4) **Qualified Service Organizations and Business Associates.** We may share your PHI with qualified service organizations, national federations or business associates who provide services to ATP. In each case, these entities will have agreements with us to safeguard and keep confidential your PHI. We will only share the minimum PHI necessary for these entities to carry out their duties to ATP.
- 5) **Patient Information Purposes.** We may use your PHI to inform you about potential treatment alternatives or options, and to notify you of other health related benefits and services that may be of interest to you.
- 6) **Disclosures in Accordance with Florida Law, Required by Law and Government Law.**

By signing the Player’s Consent and Agreement to the ATP Official Rulebook, you are agreeing that, for purposes of medical consent and release of records, the laws of the State of Florida shall govern. Certain disclosures of your PHI may be required by laws. These include, but are not limited to: (A) reports to federal, state or local law enforcement in connection with crime or threats to commit crime; (B) reports to appropriate state agencies in connection with reporting child abuse or neglect; (C) reports in connection with medical emergencies, for the purpose of treating conditions which pose an immediate threat to the health of any individual or which require immediate medical attention; (D) reports in response to court orders, if you are involved in a lawsuit or similar proceeding, or in response to a subpoena if you give us written authorization to release your PHI; (E) reports in connection with public health risk management (e.g., reporting of adverse drug reactions, notifications for recalled products or devices, required reports for certain diseases).

- 7) **Serious Threats to Health or Safety.** We may disclose your PHI as necessary to reduce or prevent a serious threat to your health and safety, or the health and safety of another individual or the public. Under these circumstances, we will only make disclosures to such persons or organizations able to help prevent such threat.

In all other situations, we will ask for your written authorization before disclosing your PHI. If you have given us an authorization, you may revoke it at any time, if we have not already acted on it. Revocation of consent is effective upon receipt of written notice, mailed via certified mail, return receipt requested and addressed to Chief Player Officer, 201 ATP Tour Boulevard, Ponte Vedra Beach, Florida 32082, with a copy (sent certified mail, return receipt requested) to Jeffrey T. Reel, 201 ATP Tour Boulevard, Ponte Vedra Beach, Florida 32082. Revocation of this consent does not affect the validity of any prior use or disclosure of your PHI. You further understand that your right to revoke this authorization shall not serve to excuse any failure by you to comply with the provisions of the ATP Tour Official Rule Book covering your affiliation with ATP Tour, or any other rule or agreement that may govern the terms and condition of your participation in tournaments.

X. EXHIBITS

YOUR LEGAL RIGHTS REGARDING PHI

HIPAA gives you certain rights with respect to your PHI. You have the right to:

- Ask us to communicate with you in a certain way or at a certain location. We will accommodate reasonable requests.
- Request that we restrict the way we use or disclose your PHI in connection with health care operations, payment and treatment. We will consider, but may not agree to, such requests. You also have the right to ask us to restrict disclosures to persons involved in your health care.
- Obtain a copy of certain portions of your PHI, subject to applicable federal, state and local laws, rules and regulations. We may ask you to make your request in writing, may charge a reasonable fee for producing and mailing the copies, and in certain cases may deny the request.
- Amend PHI that you believe to be incorrect. Your request must be in writing and must include the reason for the request. If we deny the request, you may file a written statement of disagreement.
- Have us provide you with a list of certain disclosures of PHI we have made about you. Your request must be in writing. If you request such an accounting more than once in a twelve month period, we may charge a reasonable fee.
- File a complaint if you think your privacy rights have been violated. You will not be penalized or retaliated against for filing a complaint. To file a complaint, you must contact the United States Department of Health and Human Services, Office of Civil Rights. For more information about how to file a complaint, please visit www.hhs.gov/ocr/hipaa.

By signing the Player's Consent and Agreement to the ATP Official Rulebook, you acknowledge that any health information that is disclosed in accordance with this authorization form might be redisclosed by the recipient of that information and may no longer be protected by federal health care privacy laws and rules.

If you have questions regarding your PHI, confidentiality of your PHI, or this Notice, please contact:

ATP Tour, Inc.

Attn: **Player Relations Department**

201 ATP Tour Blvd

Ponte Vedra Beach, Florida 32082

GENERAL PRIVACY CONSIDERATIONS RELATING TO PHYSIOTHERAPIST ROOMS AND TREATMENT ROOMS

This notice also is intended to remind you that the ATP Physiotherapist and/or Treatment Rooms provided at the Tournaments are not designated as a private area. Should you choose to receive treatment there, or discuss confidential information (health or otherwise), it is possible that this information may be overheard by individuals that have no obligation to refrain from further disclosure of such information. Access to these areas is not limited to ATP personnel. Players are reminded of their duties and obligations arising from the ATP Rules and Anti-Co-

X. EXHIBITS

ercion Policy. The information discussed, as well as photographic images also may be intercepted by electronic surveillance devices including but not limited to digital and other cameras, video cameras, cellular telephones and personal data devices. Neither the Tournament nor ATP is responsible for the unauthorized capturing of any PHI or other personal/confidential information or the subsequent disclosure of the same.

Should you wish to ensure the confidential nature of health or other information, we encourage you to receive treatment in a secure environment of your choosing.

X. EXHIBITS

EXHIBIT Q - Player Food Service

Recommendations for Player Food Service Planning

A. Player food should be prepared simply, with few sauces or spices. The following is a list of recommended food groups:

- 1) **Carbohydrates** (60% of total calorie intake)
 - a) Breads and Starches
Assorted multi-grain breads and rolls, bagels, crackers, low-sugar cereals, pasta (with all sauces on the side), baked (white and sweet) potatoes (with selection of toppings) and rice (preferably brown or wild).
 - b) Fruits and Vegetables
Assorted fresh fruit salad, dried fruits, whole fresh fruits, and fresh cut raw vegetables. Salad bar: tomatoes, potatoes, lettuce (variety), cucumbers, sprouts, mushrooms, carrots, peas, beans, etc. with oil and vinegar-based dressings on the side.
- 2) **Proteins** (15% of total calorie intake)
Chicken (white meat), turkey (white meat), fish (assorted variety), soft low-fat cheeses, low fat cottage cheese, low fat yogurt, hard-boiled eggs, tofu, non-fat milk. Additional recommendations are soy milk and assorted nuts.
- 3) **Miscellaneous**
 - a) Broth-based soups, (e.g., minestrone, chicken noodle, vegetable).
 - b) All sauces should be served on the side (in a warmer if necessary).
 - c) Low-fat cooking methods should be used (baked, broiled and roasted, with limited butter and oils).
 - d) Seasonings should be light; offer extra salt, pepper, garlic, etc. on the side.

B. Daily Meal Planning

- 1) When providing meals, a variety of food choices are preferred on a daily basis.
- 2) In addition to daily meals, snacks should be provided throughout the day and evening (e.g., fruits, breads and rolls, cheeses, yogurts, nuts, crackers and raisins, etc.).
- 3) If morning practices and matches are played, breakfast items should also be available (e.g., cold cereals, bagels and breads, yogurt, fruit).
- 4) Suggested lunch and dinner menus should include Carbohydrates (bread/pasta/potatoes/rice) and at least two (2) protein selections (one [1] chicken and the other fish, meat, turkey or tofu).
- 5) Practice hours and match schedule will determine when meals and/or snacks are served. Allow for during playing hours, and up until the last match has gone on court.
- 6) Each tournament may contact the ATP Sport Medicine Department for menu recommendations and/or review.

X. EXHIBITS

EXHIBIT R - Player Medical Facility Guidelines

ATP Medical Services



Treatment Room Requirements

TREATMENT ROOM REQUIREMENTS

The tournament will provide a secure, private medical and physiotherapy treatment area. The area should be easily accessible to the locker room and match courts. The physiotherapy treatment room should have temperature controls and good ventilation along with a sink (preferably with a central tap that can be turned off without hands).



Room size

Draw size 32 = 50 square meters (approx. 540 square feet)

Draw size 48 = 60 square meters (approx. 645 square feet)

Draw size 56-64 = 70 square meters (approx. 750 square feet)

Draw size 96-128 = 100 square meters (approx. 1075 square feet)

The layout design of the training room should enable each treatment table to have a minimum area of 1 meter treatment area around at least three sides of all tables.

The treatment area is to be used by the ATP physiotherapists and a separate area for physician examinations is to be provided.

If there are two training rooms being used on site, then both training rooms must have the above spacial requirements and set up.

X. EXHIBITS

Treatment Room - Equipment

One padded adjustable treatment table (electric and hydraulic) with face cut-out in good repair and sanitary condition for each ATP Physio. Additional high low table or tables will be provided for private physios.

So this means, at each 250 level tournament there will be 3 adjustable treatment tables (2 high low tables with face cut-outs for the 2 ATP Physios, and 1 high low table for private physios). At 500 level tournaments there will be 4 adjustable treatment tables, and at 1000 level tournaments there will be at least 6 adjustable treatment tables. Examples of high low tables with face cut-outs are shown in the photos below.



X. EXHIBITS

A desk, table or a counter top will be supplied with enough surface area for medical supplies and computer workstation area, examples below.



One desk chair and treatment rolling stool for each ATP physiotherapist working the event. (ie at 2 ATP physios, 500's, 3 ATP Physios and 1000 level events 4-5 physios)



A lockable cupboard large enough for medical supplies and court call bags – minimum of 3 shelves 250 event, 4 shelves for a 500 event and 5 shelves for a 1000 event.



X. EXHIBITS

A refrigerator or cooler for ice and player drinks. Ice needs to be stocked regularly and in crushed / shaved or small cube variety.



Several Automated External Defibrillators (AED's) must be available on-site with one located in the physician office. Additional AED's must be located throughout the tournament facilities such that an AED is within 3 min of every court on-site

Physician Office

The tournament will provide desk, chair, treatment table and lockable cabinets, similar to pictures above. The room must be private and separated from other areas of the treatment room to allow for private medical evaluations and consultations.

Telecommunications/computer supplies

The tournament will provide a telephone/fax machine in the doctor's room and each physiotherapy treatment area. The tournament will be responsible for cost of installation and cost for the phone line.

The treatment room will be equipped with a high-speed high-speed or wireless internet connection, with 0.6 megabit per second for uploads and 5 megabits per second for downloads at a minimum, for each ATP physiotherapist to enable use of the online medical records. This can be individual DSL/ADSL cable connections, a single ADSL line with a router and cabling to provide individual connections or a WIFI router providing adequate internet connection service to the group. This is to be provided in each training room. The tournament will be responsible for the cost of installation of the Internet connection.

The tournament will provide a printer and copier for the ATP physio to use during the tournament for medical documents.

Adequate power outlets or power boards to be supplied for operation of computers, phones, routers, hi-lo treatment tables, refrigerators, TV's, etc

X. EXHIBITS

Linen

The tournament will supply adequate towels of minimum size 60cm x 120cm (larger towels are better for players to lay on the treatment table with. For example 2 quantity 60 x 120 towels would be needed under a player as compared to only 1, 80 x 180cm sized towel). During the busy days of the tournament (qualifying Saturday to main draw Thursday) it would be usual for each physio working the event to use 50 towels per day.

Sanitation Requirements

The tournament will provide a dispensed liquid soap with paper towels in the training room for hand washing. The tournament will provide covered waste bins with pedal-control- to decrease infected waste. The training room, doctor's office and massage therapy rooms will be cleaned twice a day. This will consist of cleaning tables, chairs, equipment, and floors. Anti- bacterial wipes or spray is to be supplied for cleaning of treatment tables between treatments.



Additional Items

Ice: It is expected that at least 2 bags of ice will be used for a 32 draw size per day, 3 bags for a 48 draw and 4 bags for a 64 draw and 5 bags for a 96 draw. This does NOT include ice for making ice towels (an additional supply will be required for that). Ice bags also need to be supplied by the tournament. Durable plastic bags that do not leak are needed to assist with ice application for the players.

X. EXHIBITS

Water: Bottled still water and electrolyte drinks to be supplied for players to rehydrate while in the treatment room. All drinks must be WADA compatible and consistent with ATP requirements

Television: At least one television should be supplied with access to live scoring. An additional TV with court view is ideal so that players can watch current matches.

Massage Therapist

Each massage therapist will require a separate massage table. They will also have a separate supply of towels (minimum 30 per day) and 30 sheets per day.

The massage therapist will have close access to proper hand washing and toilet facilities. They will have lockable cupboard, waste bins, chairs for players, and one rolling stool per massage therapist.

Timing Required for Preparation of Treatment Room Facility and Equipment

All of these requirements must be ready to operate by 8:00 am tournament local time the day of Qualifying Sign-In (i.e. The day before Qualifying matches begin).

X. EXHIBITS

EXHIBIT S - Media Facilities Guidelines

A. Media working area

- 1) Adequate workspace for all credentialed media
- 2) High speed internet access *
- 3) Telephone line
- 4) Power supply
- 5) High capacity copier
- 6) Access to a fax machine
- 7) Smoke free
- 8) Lock boxes or lockers that can be used to store valuables
- 9) Security

B. Photographer workstation with internet and telephone access

C. Separate, sound proof interview room

D. Separate media lounge, where appropriate

E. Credentials

- 1) All media must be credentialed.
 - i) Proof of identity must be presented prior to receiving credential.
 - ii) Credentials must include photo.
 - iii) Credential must include the provisions set forth in Rule 6.21.
- 2) Credentials limited to members of the working press only.
 - i) Journalists known to be working for online gambling companies shall not be issued credentials. If found to be working for an online gambling company after issue of the credential, the credential shall be revoked.
 - ii) Persons who are known to work for data re-sellers shall not be issued credentials. If found to be working for a data re-seller after issue of the credential, the credential shall be revoked.
- 3) Working area, lounge and interview room must be secured with access provided only to properly credentialed media, players (interview room) and other tournament and ATP Staff when in the performance of their duties.
- 4) Members of the International Tennis Writers Association (ITWA) shall be given preferred status for workspace and court side seating.

* Unless reasonably unable to do so, tournaments shall use web filtering technology to restrict access to internet gambling sites in all areas where tournament provided internet access is provided, including all areas in the media room.

X. EXHIBITS

EXHIBIT T - Electronic Line Calling Facilities Guidelines

- A.** The ELC booth must be located in direct line of sight to the court, in order to provide an unobstructed view of the court. It should preferably be at the back (North or South end) of the court when possible.
- B.** The Review Official must have a full view of the whole court and Line Umpires.
- C.** The booth must have direct audio from the Chair Umpire's microphone (not from the Television feed).
- D.** The Review Official should be able to hear the Line Umpire calls from the court. If the CU microphone does not provide sufficient volume of court sounds, then a separate microphone and speaker must be installed to allow the Review Official to clearly hear all court sounds, including Line Umpire calls.
- E.** The booth must have room for five (5) persons plus equipment (minimum of 25 sq. meters (82 sq. feet) with a minimum court frontage of 5 meters (16.5 feet) as required by ELC vendor.
 - 1) 1 person running the system.
 - 2) 1 person dedicated to the Official Review process.
 - 3) 1 person dedicated to the television send.
 - 4) 1 additional staff of the vendor.
 - 5) 1 Review Official for each match - designated by ATP.
- F.** The booth should have full air conditioning for equipment and personnel, unless technically unable to do so, and approved by ATP/WTA and the vendor.
- G.** Access to the booth must be reasonably easy and safe.
- H.** Tables, chairs and high stools must be provided as requested by the ELC team.

X. EXHIBITS

EXHIBIT U - Review Officials Duties and Procedures for the ELC Systems

- The ELC Review Official (RO) shall be designated by the governing body responsible for the Tournament
- Attend all mandatory official's meetings and requested training
- RO team leader (Lead RO) should be appointed at the beginning of the event.
- RO's will work on a rotation basis, the schedule will be made by the Lead RO.
- In the case of a temporary RO in the booth the designated RO is responsible to make sure that the temporary RO is aware of all the local set up and booth procedures specific to that event.
- Prior to the start of the ELC system on any court, during the Chair Umpire (CU) meeting, be responsible to inform the CU's about:
 - o On site booth set up
 - o Location
 - o Conditions
 - o Type of communication with ELC Staff and TV.
- Organize ahead of time walkie-talkies with a dedicated channel for each court that is in use for each day. This can be done through the tournament supervisor or referee and the channels must be clear and not used by anyone else.
- If there are any issues during the match, the CU should speak directly with the RO who was in the booth at the time and that RO should inform the Lead RO about the situation.
- Any general ELC issues, or personal) matters should be discussed with Lead RO.
- RO to record any issues with the system, scoreboards, radios etc. and provide all the information to the final event wrap up.
- Any issues that arise should be communicated immediately to the Supervisor by the RO Team Leader.
- On the final day of the tournament, the Lead RO should send a report to the Supervisor detailing any major issues and areas for improvement.
- Be ready in the ELC Booth 20 minutes prior to the start of the 1st match
- Wear appropriate uniform as per tournament regulations.
- The RO should not leave their position until they have been replaced by the next RO. All necessary information and situations should be reported in full to the replacing RO. This change should only occur during a changeover or at a set break.
- Any issues should be reported immediately after the shift or between matches using the designated online form.
- RO assigned on first match of the day is responsible to bring all the needed equipment (walkie talkie, report paperwork if needed etc.), and the one assigned to the last match is responsible to return and charge walkie talkie and any other equipment.
- The RO is prohibited from using the internet while matches are in progress.
- No electronic devices shall be used by the RO in the booth unless approved by the tournament during matches in progress. This includes personal smartphones, smartwatches and personal tablets/laptops. The RO is prohibited from emailing, messaging or texting in any form while they are on duty in the booth and the match is in progress.
- Officials are prohibited from talking to media unless the interview has been approved by the Supervisor.
- The RO has to abide by all the Rules and procedure of the Body Government and follow the code of Conduct, the TUI rules and procedure for officials
- Any violation of this policy could be considered a breach of the code of conduct for Officials.

X. EXHIBITS

EXHIBIT U.1 - Review Electronic Line Calling System (Review ELC)

A Line calling system with a challenge process (Line Umpires on-court)

Review ELC Official (RO) Protocol

- RO shall be in direct communication with the CU.
- Most desirable method is a direct talk box with a “push to talk” button. The alternative is dedicated walkie-talkie.
- If using a computer to record the challenges load proper match into it.
- On all “potential” review impacts – Make sure you listen to the CU announcement (which line and call made) – if in any doubt radio the CU to double-check. For additional information, see Review Official Protocol for a Challengeable shot
- Alert system operators to a possible Challenge by announcing “STANDBY” Confirm that a Challenge has been requested or anticipate that there will be no Challenge. “Release to television” announcement establishes the time when the video may be sent the television.
- This applies to when either the RO determines that a Challenge will not be made or cannot be made. A visual indication that the player has accepted the call and a Challenge is not likely. Circumstances when a Challenge cannot be made would include an improper Challenge (not a point-ending shot) or when the player has no Challenges remaining. Responsible for determining that the requested impact is available for review.
- RO is responsible to send the correct shot and correct line to the videoboard for the Challenge. The RO must listen to the CU announcement (which line was challenged). And double-check if the correct ball is requested. If any doubt, confirm with the CU before sending to the board.
- Once the proper impact is determined, gives the order to send to video board and television simultaneously. The On- Court Board should be sent first if 2 different inputs need to be sent.
- Responsible for monitoring the status of the system.
- If the system crashes or is not functioning, the RO must immediately notify the CU so that the players may be informed that no review is available until further notice.
- If the RO’s monitor cannot retrieve the data to review the call, then the RO shall notify the CU that the original call shall stand.
- If the RO’s monitor is working properly but it is the Main Video Board (in-stadium video) that is malfunctioning, then the RO will notify the CU of the decision via radio or other communication device. The CU should inform the players of this at the first opportunity.
- Will notify the CU when the system is back and available for review (if the RO is satisfied that the cause has been identified and corrected).
- The RO shall notify the CU at the first available time, including during a game in progress. Before returning to “live” mode:
- Ensure that the operators have performed all their protocols when returning a system to “go” status following a crash or restart of the system.
- Act as the final authority on the number of Challenges remaining for each player or team.
- Since available Challenges will be displayed on the video board, the RO is responsible for the correct number of the Challenges to be displayed (including the additional Challenges in a tie-break or re-setting after the set break). If the video board operator is changing the Challenges on cue from the CU, then only verification is needed.

X. EXHIBITS

- If a Challenged call is not available for review – this shall not count against the total of the challenging player.
- Ensure that the RO and CU communicate verbally when one player or team has only 1 and no (0) Challenges remaining.
- Ensure that communication between RO and CU regarding the number of Challenges is made in a timely manner and considering pace of the match.

Video Board

- During the warm-up, the following statement shall appear on the video board and remain visible for at least 90 seconds. This should coincide with the Announcer’s introductions (if an announcer is used).
“This match will use Electronic Review as an officiating aid. Each player (team) will have three incorrect Challenges per set, plus one more in a tiebreak. Challenges must be made in a timely manner and can only be made on point-ending shots or when a player stops play. If, for any reason, Electronic Review of the call is unavailable, the original call will stand.”
- There shall not be any review shown in the Stadium except for “Official Review” challenges. The RO is responsible for the correct communication with the operators.
- The in-stadium video shall not replay “live” action on any controversial or re-viewed call.
- If video replays are shown between points or if the video goes live between points, the operator shall return to the scoreboard just prior to the serving player taking his position at the baseline.
- Once it is confirmed that a Challenge has been made:
 - The RO shall have direct communication with the operator of the video board and will give verbal instructions on when to show review.
 - When the RO has confirmed the impact-image is correct then the RO gives the order to send the result to board or if the RO has control of the board then sends the result personally. When sending Challenge to the board, make sure to check that what is displayed on the stadium scoreboard is the same (same line) that was confirmed with the operator and was challenged.
 - Video shows the tracking of the ball into and out of the impact area, and then the view angle is moved to show the impact mark. The “flyover” mode is used to slow the process down “to build the moment”.
- Graphic includes “Official Review”.
- Graphic at bottom of the screen shows “IN” or “OUT”. The “in” / “out” will not appear until after the overhead zoom to enhance the drama of the video. Television will receive the exact same feed as the video board with the graphic **“OFFICIAL REVIEW”** and showing **“IN”** or **“OUT”**.
- If review is not available, the RO shall notify the CU and then while the CU is informing the players, the graphic “Review Not Available - Original Call Stands” shall be sent to the video board. Reviews not available shall not count against the challenging players’ total.
 - The graphic is held until the players have reached the baselines preparing to play, at which time the board returns to the main scoreboard view.
 - The video board(s), scoreboard(s) or other location(s) must always show number of remaining Challenges for each player. This information must be part of the scoreboard build.

X. EXHIBITS

Announcing

Chair Umpire

When a Challenge is made:

- The Player shall clearly express their desire to have the call reviewed by stating, “I Challenge”. If the CU is not 100% sure that the Player is Challenging, then the CU shall confirm with the Player prior to announcing the Challenge request. When the CU is satisfied that a proper Challenge request has been made, then:
 - CU shall announce over the microphone “Mr./Ms. _____ is Challenging the call on the Base Line (give specific line) the ball was called IN/OUT”.
- After the review, CU should announce “The call stands, or the call is overturned. Then announce the score if point is awarded or replay the point and then repeat the previous score. Depending on the timing, try to also announce “Mr./Ms. X has X Challenges remaining” when there is a reduction.
- If the review is not available, simply say (after informing the players) “Review is unavailable; the original call of IN/OUT stands. No Challenge is charged to Mr./Ms. _____.”
- In the case where the line umpire is unsighted and the CU cannot make the call, if the umpire asks for a review then he shall inform the crowd of this procedure by stating, “line umpire was unsighted – the call shall be reviewed”.
- Announce the additional Challenges available at the start of each tiebreak.
- After announcing 6-games all – tie-break, announce “Both players/teams receive one additional Challenge.”
- If there are no in-Stadium Video Boards or if there is a malfunction and they are not available for use, then the CU shall use the following procedures:
 - The RO will communicate the result of the Challenge to the CU via the radio, using the following wording: “Call Challenged by [name of player] on the [name of the line]: the ball is IN/OUT”.
 - The CU will acknowledge the good reception of the information by immediately answering the RO using the following wording: “The result of the challenged call on the [name of the line] is IN/OUT”.
 - If the review is not available, simply say (after informing the players) “Review is unavailable; the call (in/out) stands”.
- In the event the video screen shows the mark OUT and the “IN/OUT” text graphic shows IN or the video screen shows the mark IN and the “IN/OUT” text graphic shows OUT, the protocol is as follows:
 - The mark determines IN / OUT not the text graphic.
 - The CU should communicate with the RO to ensure that is correct.
 - The corrected text graphic should be displayed on the big screen, so players, officials and spectators see the corrected mistake.

Additional REVIEW ELC procedures Specifically for Hawk Eye

- The RO will instruct the Hawkeye Operator that when the command “Stand By” is given, the operator will immediately say if the ball is “in” or “out” and give the measurement.
- Confirm specifically with the VR Operator that:
 - The system is set for the appropriate event (singles or doubles)
- During warm-up, view at least one (1) test review.
- At 1 min. announcement, confirm with the System Operator and the VR Operator that all systems are good to go.

X. EXHIBITS

- In doubles, when the score reaches “Deuce” – deciding point, tell the Hawkeye Operator if the receiver will be from the “Deuce” or “Advantage” side.
- Before sending the Challenge to the video board double-check that the distance and the decision “IN” or “OUT” given by the Hawk eye operator is corresponding with the image on the RO screen (serve, rally, singles, doubles etc.)

Additional REVIEW ELC Procedures Specifically for FoxTenn

In general, the role of the RO when working with FoxTenn is the same but there are some differences, which are going to be mentioned here.

Pre-match:

- Check with the Operator that they have calibrated the lines for the appropriate event – singles or doubles.
- During the warmup look at one image of the ball to make sure the system is ready.
- **When the match starts:**
- When giving “Standby”, the RO must also give the exact line. So, for example: “Standby –left near sideline”.
- For FoxTenn it’s very important to give the “Standby” as soon as possible because they must capture the image immediately to avoid long delays. So, the RO should be giving more “Standby” commands. Give the “Standby” every time if there is any chance there will be a Challenge.
- When the Challenge is made the RO will be looking at the live image and needs to confirm the bounce on the live image. There will be no numbers on the screen, so it’s **IMPERATIVE** that the RO watch the match all the time to know which bounce it is.
- When the VR operator says “ready”, the RO should have graphic image of the mark on the RO’s screen with the decision “in” or “out” written. Then the RO can send the Challenge to the video board.
- When the Challenge is shown on the video board there are two images shown: the live image of the ball and graphic image of the mark with the decision “in” or “out”. There may be instances when only one of those two images will be shown.
- Do not “Release” the Challenge too early. It’s better to hold it longer, until the RO is 100% sure there will be no Challenge, or the next point is about to start. If the RO has a Challenge after it was released, it will cause a longer delay.
- There will be no distances given from FoxTenn, only “in” or “out”.
- As FoxTenn operates differently than Hawkeye, there is no option to look at some of the close balls from the points played, so, do not ask for that.
- **IMPORTANT** to remember **LANGUAGE** to use:
 - **STAND BY** and the line (ex. **STAND BY LEFT BASE**)
 - **WORK ON IT** (when it’s not sure if the ball will be Challenged)
- The CU’s chair is shown in a different position based on which camera is in use, but the **ORIENTATION POINT IS ALWAYS** the CU’s chair, so, left base will always be left base in relation to the CU’s chair, regardless of what side of the screen the chair is located at that particular Challenge.

Additional REVIEW ELC Procedures Specifically for FlightScope

At the beginning of the match Remember to check the

1. INITIAL SCREEN

- To ensure the correct match is loaded
- To ensure the player names are at the correct side of the court (after the coin toss)

X. EXHIBITS

- To ensure the number of Challenges for each player is correct.
 - When there is a Challenge press the button **START CHALLENGE**.
2. When the RO presses **START CHALLENGE** the RO will see (**WAITING FOR DATA**)
 - If **DATA is displayed go to point 3,**
 - if **DATA NOT AVAILABLE is displayed, go to Point 8**
 3. If **DATA** is received the RO will have to **choose the ball**, which the RO can do in 2 ways:
 - Press the dot with the number on the court (after the dot is pressed it will become red), or
 - Press the number at the bottom of the screen (yellow balls above **“CHOOSE BALL”** writing)
 4. After choosing the ball, the RO needs to double-check if the RO has chosen the correct ball and **CONFIRM BALL**
 5. Next step is to **confirm/change the area** (darker grey color) to the correct area
 - If it is a serve, then one of the service boxes should be in darker color – if it's incorrect, touch the screen to change the box
 - If it is a rally, the whole half of the court (singles/doubles) should be in a darker color.
 6. When the RO confirms the area, the RO will see the screen with the information: **“WAITING FOR RESULT”** If **NO SHOTS WERE RECEIVED go to point 8.**
 7. After the RO receives the result the RO will have to **PREVIEW the Challenge** – if everything is good and correct, press: **START ANIMATION** (system won't let the RO send the Challenge to the board before the RO previews the Challenge)
 8. At point 2 or 6 the RO might receive the screen with the information **“NO DATA RECEIVED”** or **“NO SHOTS WERE RECEIVED”**
 - If **“NO SHOTS WERE RECEIVED”**, the procedure is to ask the operator: **“Do you have it?”**
 - o **YES** –the operator will input the rally from their computer to the tablet or
 - o **NEED MORE TIME** – the operator will look for the rally and input it to the tablet or
 - **In both cases the RO needs to go back to the original procedure – DATA available Point 2/ SHOT available Point 7)**
 - **NO – ORIGINAL CALL STANDS** (the RO presses the red button located under match time in the right top corner), see below

IMPORTANT INFORMATION:

1. Any time that the RO presses the button **START CHALLENGE** the system is **LOCKED** and is not recording anything further, the RO has buttons that can be used in case a Challenge is not happening or has been cancelled:
 - If **“WAITING FOR DATA”** or **“WAITING FOR RESULT”** press **DISMISS**
 - In any other case press **RELEASE** (located in the bottom right corner)

NOTE: It is **very important** to **DISMISS/RELEASE** as soon as it is known that there won't be a Challenge to have the system fully functioning.

X. EXHIBITS

2. Another button that the RO can see is **BACK** – it can be used to go one step back at the time.
3. In point 7 the RO sees the button **REPLAY** – which can be used to replay the preview of the Challenge as many times as needed before the RO **START ANIMATION**.
4. In point 3-5 two buttons can be seen - **PREVIOUS** and **NEXT** – this is the option to see all the bounces (long rally) as on the RO's screen when the RO presses **START CHALLENGE** the RO will see the last 5 bounces – **It is strongly recommended NOT TO USE these buttons** unless necessary (there should be no reason to allow the Challenge of the ball that is 5 shots or more back).

This system is provided by FlightScope, who at some events is also providing other services (e.g. Scoreboards).

At some events whenever the RO presses **START ANIMATION** it will go directly to the scoreboard and will automatically go off-board when the animation is finished (the RO will have the option to press the button **OFF BOARD**-located in the bottom left corner-earlier if needed).

If FlightScope is not operating the scoreboards there will be an extra step when the RO releases it, the Challenge will be sent to the vendor who will be responsible to send to the board.

X. EXHIBITS

Review Official Protocol for Challengeable Shot

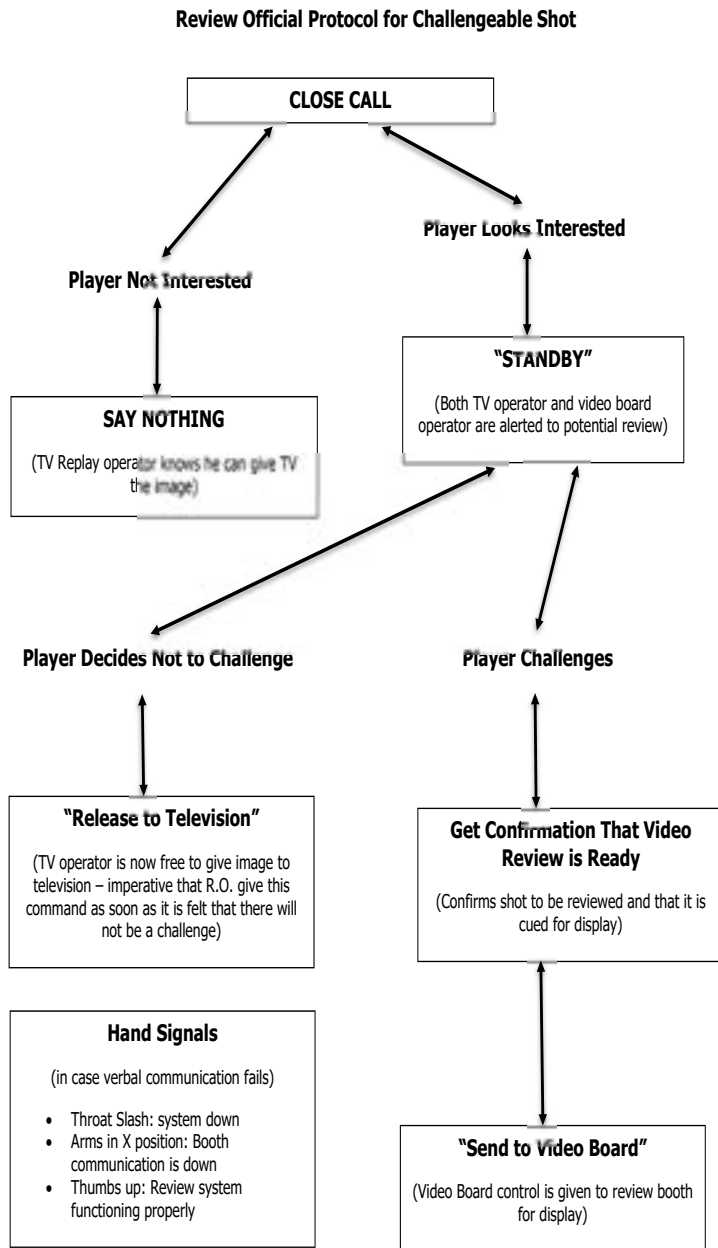

X. EXHIBITS

EXHIBIT U.2 - Live Electronic Line Calling System (LIVE ELC)

A line calling system making automated line calls with no Line Umpires on-court.

LIVE ELC Review Official Procedures and Protocols

The players do not have any challenges when using the LIVE ELC and therefore the RO duties are different than when using the REVIEW ELC system.

Review Booth Procedures

- Prior to the first match of the day, confirm with the System operators that all sound and system checks have been completed, if not please request a sound and system check.
 - Communication to the CU should be limited to essential communication as live microphones are on court.
 - Confirm that close calls have been tested and sent to the board.
 - **Note:** The RO should not do sound checks or close call checks to the board upon arrival in the booth other than prior to the first match. This will disturb the production of the event and could be heard on television broadcast which should be avoided. If any issue, it is always suggested to do an extra check if possible.
 - Confirm specifically the system is:
 - o Set for the right event **singles/doubles**. If singles confirm regular scoring is activated. If doubles confirm no-ad scoring is activated.
 - o At 1 min in the warmup confirm system is armed and ready to go.
 - Perform a radio test with the CU during the warm-up to make sure the CU's radio is on and to find out who is serving first.
 - o Inform the Operator who is serving first and from which end of the court.
 - The RO has a monitor that will show 3 camera angles. The camera should be set to watch the server and it is the responsibility of the RO to call foot faults if they occur.
 - o Foot fault cameras are available for center serve and the base line on both ends. To toggle between each end, use the F1 and F2 keys on the keyboard. The CU is responsible for calling sideline foot faults.
 - o If a foot fault occurs press the foot fault button making sure to wait until the player has struck the ball. This will make an audible "foot fault" call over the speakers.
 - If any foot fault camera becomes inoperable either by loss of video or it is knocked the RO should inform the operating staff so they can send someone down to fix it. If the RO can still call foot faults using the other cameras they should continue to do so. If ALL cameras lose video or the foot fault camera PC crashes, the RO should communicate this with the CU and inform them they will need to call foot faults from the chair until the cameras are operational again. Once cameras resume operation, inform the CU that the RO can start calling foot faults again.
 - Close calls will be shown on the board in one of two ways depending on system set up. Automatically or Manually.
 - o **Automatic System:** Automatic replays of close calls will be shown on the video boards (if video boards are available). These replays will be on **point-ending non-service shots** that are in or out by 150mm or less. The replays will be of **point-ending service shots** that are in or out by 50mm or less.
- Note:** Close calls between first and second serves that can disturb play should be cancelled from going to board by the RO using the cancel button.

X. EXHIBITS

- o **Manual System:** The system works the same as above except the close calls do not go automatically to the board. The RO is responsible for sending close calls to the board and taking them off again. Normally this is done simply with the press of a button.

Note: Close calls between first and second serves **that can disturb play** should not be sent to the board by the RO.

- If a player wants to see a replay of a shot outside of this range (150mm & 50mm) the CU should announce “Mr./Mrs. (players name) is requesting the replay of the call on the (line)” to alert the RO and the operator. Play must not continue until the replay has been shown on the board.
- If it is suspected that the LIVE ELC System malfunctioned or failed to decide on a call this call may be made by the CU. This protocol will only apply on point ending shots or when a player stops play.
- The CU should communicate with the RO to confirm if the system was able to decide.
- If the RO can confirm the ball is “in” or “out” then the CU should acknowledge the result and inform the players.
- If the system is not available and the CU is unable to make a call, the point should be replayed.
- There is sometimes a slight delay on the “out” call. This can in some situations create confusion and if this happens the CU might contact the RO. The RO should confirm the outcome of the call.
- If play continues after the Electronic Line Calling Live System has determined a ball is out, the RO should deploy the Stop Play Protocol from the booth by pressing the stop play button triggering an audible “Stop, Stop” announcement on court. The RO should communicate the explanation of the out call to the CU and the CU should inform the players of the decision by the system.

Note: This can happen for a number of reasons, players and CU did not hear the audio out call, the audio out call failed, the operator has stopped the point too early effectively disarming the system so there is no audio call.

- The RO has the **responsibility** of making sure that the correct service box is selected by the operator at the start of every point. A view of the court should be visible on the ROs screen with a highlighted service box. The highlighted service box indicates the “active” box to which the system shall decide if the serve is in or out. On any match where the “no-ad” scoring system is being used when the score reaches “deuce” the RO should inform the operator if they will be serving to the **deuce** or **advantage** court.
 - o If the RO sees, for any reason, that the wrong box is highlighted before the start of the point, they should immediately tell the operator to change to the correct box before the serve is hit.

Note: It is very important to always keep a close eye on the service box selection by the operator especially if anything odd or unusual happens during the point. Let 1st serves, let 2nd serves, let replay the point, touch, are just a few unusual situations where the operator may not be aware of what has happened and may have the incorrect score and therefore the incorrect service box highlighted.

- On “let” serves repeat “let 1st serve” or “let 2nd serve” to ensure the operator knows whether it is a 1st serve or 2nd serve.
- If there is a malfunction of the LIVE ELC System and it is not functional the match must be **stopped**. The RO should contact the CU immediately and inform the CU that the system is not operational. The supervisor/referee should also be contacted.

X. EXHIBITS

- o The RO should keep in radio contact with the CU and supervisor/referee and inform them on how long it is expected before the system is again operational.
- o The supervisor/referee will then decide on how/when/where the match will resume again.
- o If it is deemed the system will be operational in a short reasonable time the players will wait on court and resume play when the system is available.
- o If it is deemed the system will not be available in a reasonable time, the supervisor/referee will decide on another option. These could include suspending the match, moving the match to another court, using line umpires (if available), postponing the match or continuing the match without the system and the CU calling **ALL** the lines.
- o The RO should note the time of the match and the score when the system became unavailable and also the time when the system became available again. The Lead RO should then be informed of this either at the end of the shift or between matches.
- The RO should record the time and the score of any system malfunctions or unusual situations with the LIVE ELC System and report them to the Lead RO after their shift or between matches.
- If the LIVE ELC System is operational but the audio speakers around the court fail the match should not be stopped. The CU must use the LED lights (green and red) on the chair to determine if the ball is “in” or “out” and must call audibly by themselves.

X. EXHIBITS

EXHIBIT V - Anti-Doping Testing Facilities Guidelines

Doping Control Station

The Doping Control Station must be a dedicated facility for the exclusive use of the Doping Control team for the duration of the event.

Location: near the locker room (but not with direct access).

Accommodation: a minimum of two (and preferably three) connected areas or rooms: a Sample Collection Room and a Waiting Room at a minimum, plus an Administration Room if possible, all of which should be air-conditioned or well ventilated. The Sample Collection Room should be directly connected to a toilet (for the sole use of Doping Control).

Security: If free-standing, a security guard should be posted to restrict admission to those with appropriate credentials. It must be lockable, with access restricted to the Doping Control team. The Doping Control Officer must be given charge of all keys to all rooms for the duration of testing.

Hygiene: The Doping Control Station should be cleaned every day at a time agreed with the Doping Control Officer.

Items to be supplied in the Doping Control Station (for all draw sizes):

SAMPLE COLLECTION ROOM	WAITING ROOM
1 toilet	Comfortable seating for 8 people
Desk and 4 chairs	Refrigerator with an adequate supply of individually sealed, non-caffeniated and non-alcoholic beverages
Table to display testing materials	Table to display reading materials
TV/Court Monitor (and also in the Administration Room if provided)	TV/Court Monitor
Mains electricity supply	Waste bin
Lockable refrigerator	
2 large waste bins	
Sink, with soap or hand wash	
paper towels	
Storage cupboard	

A suggested layout for a doping control station is shown in the following diagram:

X. EXHIBITS

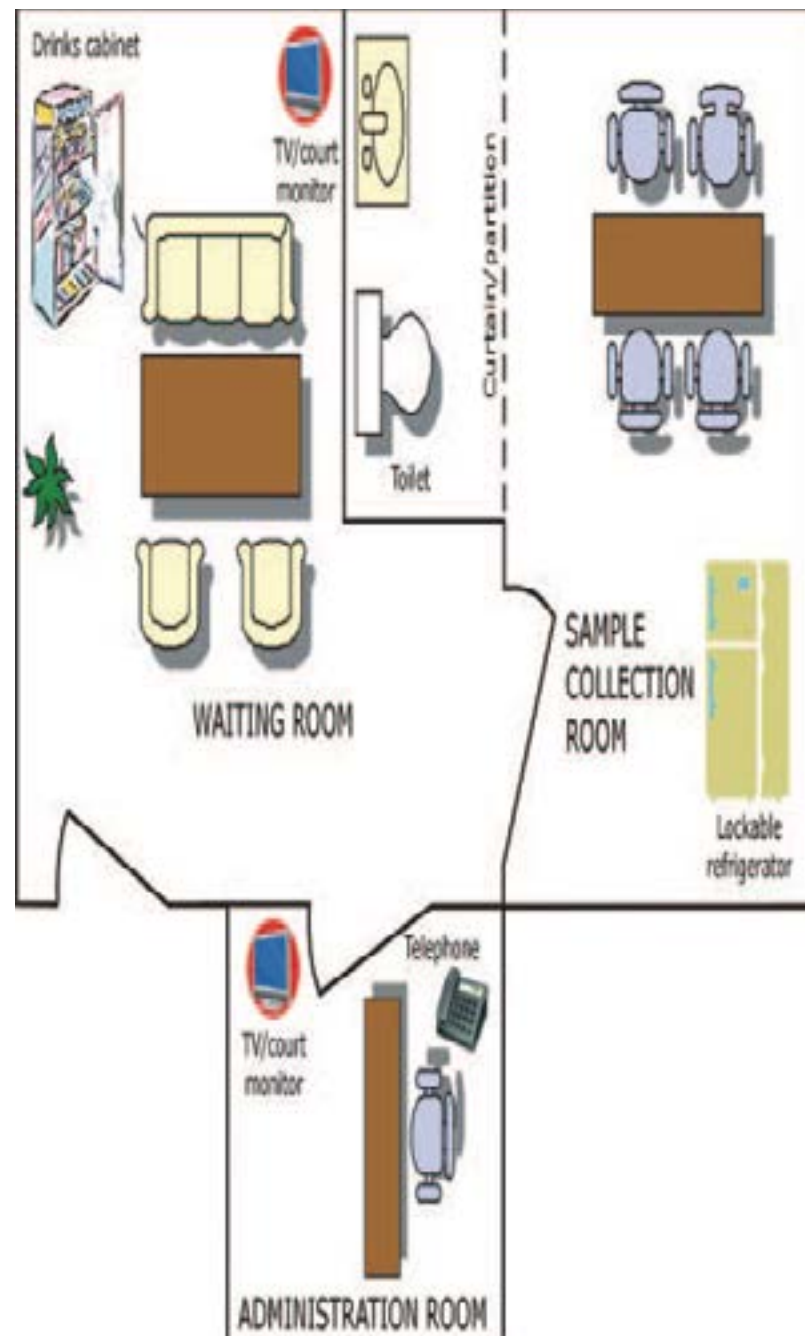

X. EXHIBITS

EXHIBIT W - Retractable Roof Policy

Whenever practical, playing conditions on the center court will remain the same as on all other courts.

In the event rain is falling prior to the scheduled starting time of the match, the roof will remain closed for the duration of that match.

If the rain stops and the forecast is good, the roof may be opened after the match in progress is completed. Decisions on re-opening the roof will be made on a match-by-match basis depending upon current conditions and the forecast.

If play commences with the roof open, a decision to close the roof will normally be made after play has stopped because of rain, although if other factors warrant the roof to be closed prior to this, the Supervisor will make that decision.

The roof will not normally be closed because of the threat of rain.

In the event high winds, sufficient to harm the retractable roof, are forecast with reasonable certainty, the roof may be closed prior to the start of the match. The reverse is applicable when the roof is closed and high winds or other conditions necessitate, for safety reasons, that the roof be opened.

In the event that the temperature is below 50F / 10C prior to the start of a match, in order to enhance the fan experience, the roof may be closed as directed by the Supervisor. Decisions on whether to close the roof for cold will be made on a match-by-match basis.

In some instances, the roof must be partially closed for the lights to function properly. In this case, the roof must be partially closed prior to the start of the match.

The ATP Supervisor shall be the final authority on all decisions regarding the

X. EXHIBITS

EXHIBIT X - Writing Table For Umpire Chairs

In an effort to provide a comfortable platform for the Chair Umpires to place their hardware such as tablet, walkie-talkie, net device handset, it is requested that all tournaments attach a writing table according to the instructions below to the Chair Umpire's chairs on all match courts.

This simple and low cost upgrade will contribute tremendously to reduce scoring errors caused by data being accidentally entered as a result of the umpire holding the tablet in their hand and ease the process of entering data in the tablet.

When setting up the writing tables, please make a note of the following:

- Attach the writing table to the right side armrest. If there is a microphone attached to the chair, the microphone must be installed on the left side of the chair so as not to interfere with the writing platform on the right side armrest.
- Ensure that the writing table is installed with the slender end at the back of the armrest. The design is made considering most armrests are 20 inches (50.8 cm) long and 3 inches (7.62 cm) wide. This design calls for the overall dimension of 32 inches (81.28 cm) which leaves a full 12 inches (30.48 cm) of space in front of the umpire for the various equipment.
- A standard wood product could be used. For example, in the USA a 1 x 12 could be used and just cut to length and ripped for the 9 x 20 piece that is taken out. The actual dimension of a 1 x 12 is 11 ½ inches wide by ¾ inches thick. A comparable product could also be used in countries using the metric standard.



X. EXHIBITS

Writing Table

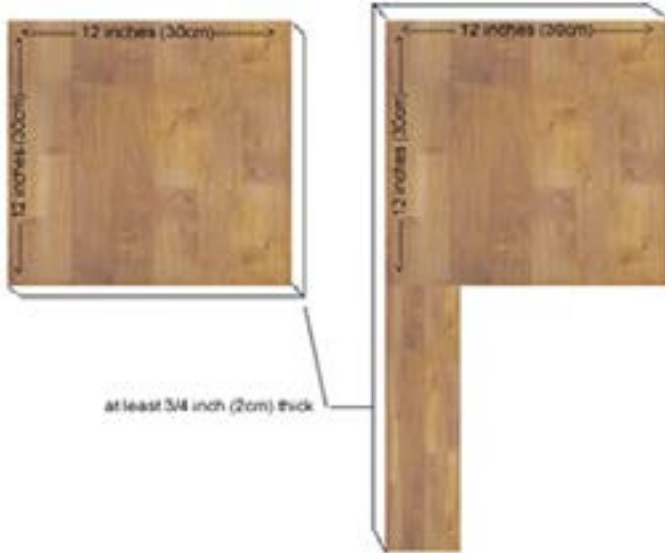

X. EXHIBITS

Writing Table



writing table should be installed so that the main writing surface extends past the end of the armrest by at least 9 inches.



X. EXHIBITS

EXHIBIT Y - Premier Player Protocol

Premier Player Group. Players ranked as a year-end top 30 player (commitment players) or have a current protected ranking within the top 10 are eligible to be selected in the premier player group for purposes of fulfilling the restriction on who is eligible to be named as an additional Wild Card at an ATP Tour 500 event. The size of the premier player group shall be six (6) players plus two (2) alternates selected as follows:

Six (6) players shall be selected as “regional” premier players (A+) by each of the three (3) regions (Americas, European and International). Each region shall also designate two (2) alternates as A1 and A2. The regional EVP’S shall solicit input from their respective events to determine the six (6) regional selections, plus alternates. These six (6) players and the two (2) alternates shall be presented to the Board at the final Board meeting of the previous year for approval.

In the event that an A+ player becomes injured or otherwise is not able to compete for an extended period of time, as specified below, he will be replaced by the A1 player designated by the region.

The same procedure will be followed in the event that a second player needs to be replaced as determined below.

If additional A+ players are required and the designated A1 and A2 players have already been promoted or are otherwise not available, then the A+ replacement player will be the next highest ranked player on the most current Pepperstone ATP Rankings.

Replacement protocol. The replacement of a Premier Player will automatically occur when any of the following apply:

- 1) A Premier Player has withdrawn / retired from an event due to illness or injury and has been out of competition for sixty (60) days; or
- 2) A Premier Player has announced that due to illness / injury or other reasons he will be out of competition for a period of at least sixty (60) days; or
- 3) A Premier Player announces his retirement; in this case he is replaced immediately following his last event.

Note: The count shall begin on the withdrawal deadline date; the date of the retirement; the date of the late withdrawal; or the date of the on-site withdrawal, whichever was chronologically first.

A player must not compete in any other tennis event during those periods.

If the replaced player returns to competition during the season, he shall be reinstated as a premier A+ player upon the start of his first match (singles or doubles) in his first ATP Tour event.

X. EXHIBITS

EXHIBIT Z - Player Gym

The minimum requirements for the on-site player gymnasium are as follows:

ATP Tour Masters 1000 / 500 events

Area:

Draw Size	32	48/56	96
Gym Size (area)*	75 m ² / 807 sq ft	100 m ² / 1,076 sq ft	125 m ² / 1,345 sq ft

*For joint events the size is to be increased by 50%.

Equipment:

Draw Size	32	48/56	96	Comments
Equipment:				
Treadmills	2	3	4	
Stationary bikes	2	3	4	
Elliptical machine	1	1	2	
Free weights	1 set	1 set	2 sets	Set = 1,2,4,6,8,10,15 kg (2 of each weight)
Exercise mats	4	6	10	
Swiss balls	2 sets	3 sets	4 sets	Set = a 50 cm ball and a 75 cm ball
Cable machine or similar	1	1	2	Similar to a Bilt QUAD machine
Sets of bands	2 sets	3 sets	4 sets	Set = 3 different resistance bands with handles
Wobble board	1	1	2	Example: Bosu Pro-Balance trainer/ Theraband Balance platforms (foam)
Weighted balls	1 set	1 set	2 sets	Set = 1,2,4, 6 & 8 kg balls
Foam Rollers	2	2	3	

Additional Equipment / Supplies:

- a) Adequate supply of bottled water for hydration.
- b) Anti-bacterial wipes for hygiene.
- c) Mirrors on walls (to check form).
- d) TV monitor(s) for live scores and live action.
- e) In addition to floor space for cardio equipment and weight machine(s), there must be ample space for functional exercises and utilization of the medicine balls, Swiss balls, and free weights and tubing. Area for stretching and work with coach, physio or strength and conditioning specialist is as important as the footprint for the cardio and weight machines.

ATP Tour 250 / Challenger events

- a) All ATP Tour 250 events shall provide on-site and free of charge a fully equipped gym of adequate size with the proper equipment as shown above under requirements for a 1000 / 500 event. If the Official Tournament Hotel has a fully equipped gym, which is available to all players free of charge, then the tournament must provide at a minimum an area designated for warm-up / cool-down with the minimum amenities hereinafter set forth in Section c):

X. EXHIBITS

- b) All Challenger Tour 175, 125 and 100 must provide on-site, off-site within a reasonable distance from the tournament site/official hotel or at the official tournament hotel and free of charge a fully equipped gym of adequate size with the proper equipment as shown above under requirements for a 1000 / 500 event. If the tournament gym is off-site, then the tournament must provide at a minimum an area designated for warm-up / cool-down with the minimum amenities hereinafter set forth in Section c).
- c) The on-site warm-up/cool-down area should be large enough to allow for stretching, functional exercise, as well as to use the cardio equipment (treadmill and bike). In addition, the following amenities shall be provided at a minimum:
 - a) 1 treadmill
 - b) 2 upright stationary bikes
 - c) Stretching area with exercise mats
 - d) 2 sets of elastic bands
 - e) 1 set of medicine/weighted balls (see recommended weights in 1000/500 section hereinbefore set forth
 - f) 2 foam rolls
 - g) 1 set dumb-bells (see recommended weights above in 1000/500 section hereinbefore set forth
 - h) 1 Swiss Ball
 - i) 1 wobble board/foam balance platform

X. EXHIBITS

EXHIBIT AA - Mandatory Physical



MANDATORY PHYSICAL / COMPETITION CLEARANCE

Please Print Clearly: All Illegible Forms Will be Returned Without Processing

Player Name: _____ Date of Birth (DD/MM/YYYY) ____ / ____ / _____

I certify that _____, a patient of mine has been medically evaluated and is:
[Insert player name]

Check One:

Deemed medically fit to participate in playing competitive tennis

Not deemed medically fit to participate in playing competitive tennis

DATE OF EVALUATION: _____

LOCATION OF EVALUATION (City & Country): _____

LIST ANY **SIGNIFICANT** MEDICAL CONDITIONS YOU WOULD LIKE ATP MEDICAL SERVICES TO BE AWARE OF: _____

I further certify that I am a Medical Doctor (MD) licensed to practice medicine in (Country) _____.

License Number: _____.

Print Name of Physician

Signature of Physician

Email of Physician

Date: _____

Contact Telephone Number: _____

*****IMPORTANT INSTRUCTIONS TO PHYSICIAN*****

Please immediately fax the completed form to the attention of Todd Ellenbecker at +1.904.758.5312 or scan and email the form to: todd.ellenbecker@atptour.com

X. EXHIBITS

EXHIBIT AB - Clothing Logos

ATP PLAYERS' DRESS AND EQUIPMENT

All commercial ID logos placed on the shirt front or collar must be embroidered or screen printed. All manufacturer logos must be embroidered, screen printed or otherwise professionally attached at all points



BAGS, TOWELS, ETC.

Tennis Equipment Manufacturer's ID on each item **PLUS**
BAGS - 2 commercial ID (6 sq in/39 sq cm) on one (1) bag

HAT, HEADBAND

1 Manufacturer's ID and/or 1 Commercial ID* (4 sq in/26 sq cm) Writing is permitted on both
 *Commercial ID must be on side of hat/headband and worn so it is positioned on side of head
 (NEW - see example)

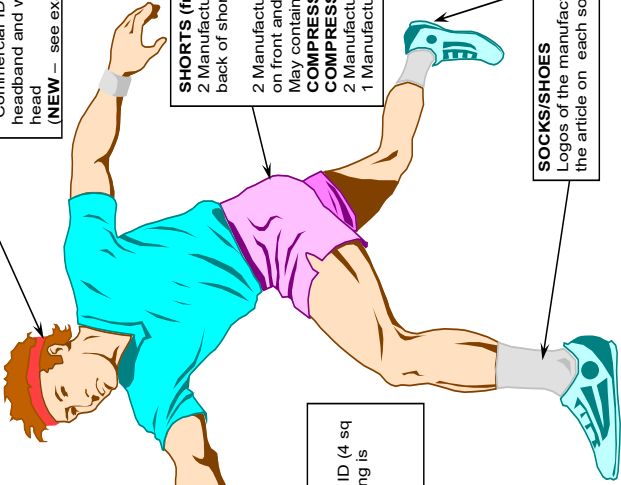

RACQUET & STRINGS

Manufacturer's ID on racquet and strings

WRISTBAND

1 Manufacturer's ID (4 sq in/26 sq cm) Writing is permitted

SHORTS (front and back)

2 Manufacturer's ID (2 sq in /13 sq cm) on front or back of shorts
 OR
 2 Manufacturer's ID (4 sq in/26 sq cm) placed 1 on front and 1 on back
 May contain writing

COMPRESSION SHORTS and/or

COMPRESSION SLEEVES

2 Manufacturer's ID (2 sq in/13 sq cm) OR
 1 Manufacturer's ID (4 sq in/26 sq cm)

SOCKS/SHOES

Logos of the manufacturer of the article on each sock/shoe

The Adidas three stripes™ is considered a manufacturer's identification

X. EXHIBITS

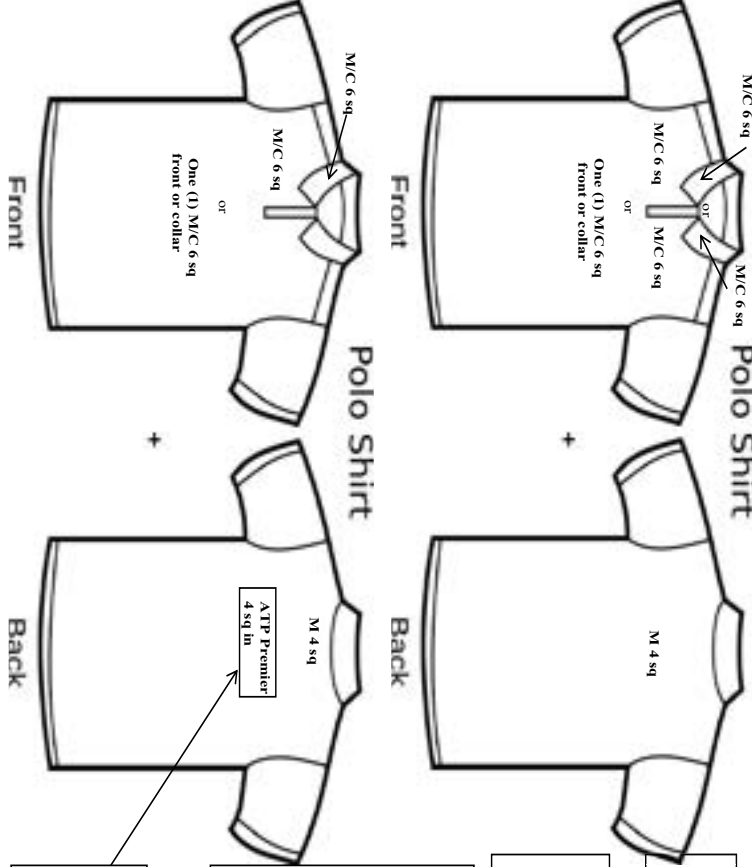

SHIRT, SWEATER OR JACKET - Front, back & collar

ATP PREMIER/PLATINUM SPONSOR PATCH
 An additional Commercial ID (4 sq in) may be placed on the back of the shirt (below the collar) if part of the ATP Premier/Platinum sponsor patch program. This is optional and is in addition to any Manufacturer ID on the back of the shirt.

As long as only 1 Manufacturer/Commercial ID (6 sq in) is placed on the front, an additional manufacturer's ID (up to 4 sq in) can be placed on the back.
 Logos may contain writing.

No new commercial logo may be added to the shirt front for events following the US Open through the Nitto ATP Finals.

*Once a player has competed in his 1st match with a commercial brand logo on the front, collar or head-gear, then he cannot change brands during that year without ATP approval.

OR
 1 Manufacturer's or Commercial ID (6 sq in/39 sq cm) on front or collar
PLUS
 an additional 1 Manufacturer's ID (4 sq in/26 sq cm) on the back

2 Manufacturer (M) or Commercial (C) IDs (6 sq in/39 sq cm) in any location (2 on front, or 1 on front and 1 on collar
 Logos may contain writing.

X. EXHIBITS

Sleeveless

Polo

Sleeves

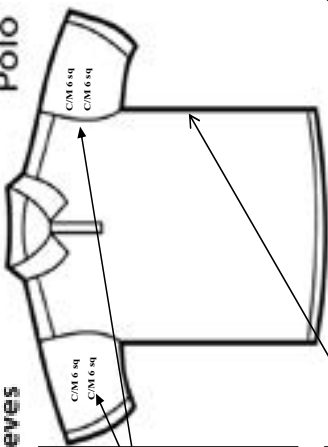
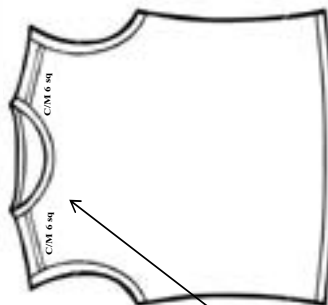

SLEEVES
 2 Commercial (C) ID (non-manufacturer) or Manufacturer ID on each sleeve not to exceed 6 sq in/39 sq cm
 Maximum of 2 ID's may be placed Within each 6 square inch position.
 1 patch = 6 sq in

C/M	C/M
-----	-----

NOTE: Commercial ID's can be different. Logos may contain writing.

OTHER
 1 Manufacturer (without manufacturer name or writing may be placed once or repeatedly within an area not to exceed 12 sq in in one of the following locations:
 On each of the shirt sleeves OR
 On the outer seams (sides of the torso)

SLEEVELESS
 If sleeveless, then 2 logo positions of the Commercial (C) ID (non-manufacturer) or manufacturer ID may be placed on the front, however neither shall exceed 6 sq in/ 39 sq cm.
 If only one logo is placed on the front or collar, then one manufacturer logo (4 sq/ in/26 sq cm) may be placed on the back of the shirt.

HAT/HEADBAND
 1 Manufacturer's ID not to exceed 4 sq in/26 sq cm and/or
 * 1 Commercial (C) ID (non-manufacturer) not to exceed 4 sq in/26 sq cm.
 •The Commercial logo must be on the side of the hat/headband and must be worn so that it is positioned on the side of the hat.
 •No hat or headband with or without logos may be worn during the awards ceremony.
 *Once a player has competed in his 1st match with a commercial ID, then he cannot change brands during that year without ATP approval.

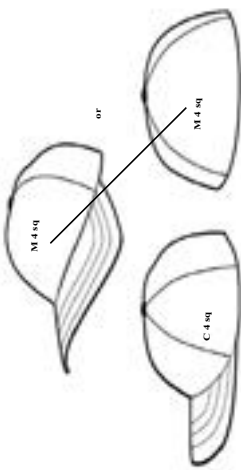

X. EXHIBITS

EXHIBIT AC - Sample Basic Accreditation Policy Wording

1. SCOPE AND TERM OF ACCREDITATION

- 1.1. This accreditation policy (the **Policy**) shall be binding on any person (the **Accreditee**) who has applied for or been issued with a temporary or permanent accreditation (the **Accreditation**) by or on behalf of **[insert name of Tournament owner]** (the **Accreditor**) in respect of the **[insert year]** **[insert Tournament name]** (the **Tournament**) whether on his/his own account, on behalf of an employer, or on behalf of any person or company he/she is working with (in whatever form) in respect of the Tournament.
- 1.2. With effect from the date of signature or online acceptance of this Policy, this Policy shall supersede and replace any prior agreement, understanding, arrangement, representation or document, whether written or oral, entered into between the Accreditor and the Accreditee with respect to the subject matter of this Policy.

2. TERM

- 2.1. This Policy shall come into effect and be binding as between the Accreditor and Accreditee from the date of signature or online acceptance of this Policy by the Accreditee and shall terminate upon the conclusion of the Tournament in the relevant year (save that the Accreditee and the Accreditor agree that paragraphs 3.1.3, 3.1.5, 3.1.11, 3.1.13, 3.1.21 (inclusive) and paragraphs 4, 5 and 6.4 shall survive expiry or termination of this Policy).
- 2.2. The Accreditation provided to the Accreditee shall at all times remain the property of the Accreditor and be subject to the Accreditee complying with the terms of this Policy. The Accreditor may, at any time and in its sole discretion: (i) terminate this Policy; (ii) rescind any Accreditation provided to the Accreditee for the current year; (iii) reject any applications for future Accreditation; and/or (iv) eject the Accreditee from the Tournament site, and/or take legal action against the Accreditee for breach of this Policy.

3. TERMS AND CONDITIONS

- 3.1. In consideration for the grant to the Accreditee of his/her Accreditation, the Accreditee hereby agrees, undertakes and/or acknowledges (as applicable) that:

General

- 3.1.1. the Accreditation is strictly non-transferable and in particular the Accreditation may not be used as a prize or give-away or as part of any competition or promotion or other similar activity;
- 3.1.2. the Accreditation must be worn correctly at all times (with any photo clearly visible – if applicable) and be visible and accessible to be scanned or otherwise checked prior to entry and exit from the Tournament site, and at relevant areas within the Tournament site, at all times;
- 3.1.3. he/she shall not alter, edit or otherwise amend the Accreditation or make or take any copy of the Accreditation or provide any third party with the Accreditation, any photograph or copy of the Accreditation (whether directly or indirectly by way of social media for example);
- 3.1.4. he/she shall abide by all instructions, orders and directions given to the Accreditee by the Accreditor or any Tournament official, employee or agent and if the Accreditee is at any time unsure whether to comply with such instruction, order or

X. EXHIBITS

direction he/she must contact

- 3.1.5. to the extent permitted by law, the Accreditee grants (free of charge) to the Accreditor and ATP Tour, Inc. (the ATP) the perpetual right to make and use, exhibit and reproduce worldwide at their discretion, the Accreditee's name, voice, biographical material, likeness, image and/or any visual description of the Accreditee made during the Tournament for: (i) promotion and publicity of the Tournament; (ii) information and news in relation to the Tournament; i) audio visual coverage and broadcast of the Tournament; and (iv) archive purposes. The Accreditee acknowledges and agrees that such use of his/her name, voice, biographical material, image and/or any visual depiction by the Accreditor or the ATP may be affected by way of any technologies, distribution techniques or media and without compensation;
- 3.1.6. he/she shall conduct himself/herself and act generally in a manner that will not: (i) bring the Tournament, the ATP (or any of its subsidiaries), the Accreditor or the game of tennis into disrepute; or (ii) otherwise inhibit the enjoyment of any other party in attendance at the Tournament.

Ground Regulations/Access

- 3.1.7. he/she shall comply with the Tournament Ground Regulations which can be found at [\[insert web address\]](#) and as attached as Appendix 1 to this Policy;
- 3.1.8. he/she shall directly or indirectly access only those areas of the Tournament site specifically allowed by the Accreditation and necessary for the Accreditee to perform activities directly related to the purpose for which the Accreditation as granted;

Players

- 3.1.9. he/she shall not film any player anywhere within the Tournament site without having obtained the player's prior written permission, unless the filming is being done for noncommercial purposes and is not for more than :60 seconds;
- 3.1.10. players and their registered coaches may film a players' practice session within the Tournament site provided that such film may only be used for their own personal use and shall not be used for any commercial purposes.
- 3.1.11. he/she shall not expressly or impliedly associate any player with any products, services or brands (including, but not limited to, the products, services or brands of the Accreditee's employer);
- 3.1.12. players' press conferences shall be held in press conference rooms or other designated areas, and only authorized accredited media representatives may access the press conference;

Photographs/Filming (General)

- 3.1.13. other than where approved in advance in writing by the Accreditor or as set out in paragraphs 3.1.14.8, 3.1.15 and 3.1.16 below, the Accreditee is strictly forbidden to film, broadcast, stream, publish, transmit and/or otherwise offer to the public (or assist any third party in offering to the public), on a live or on a delayed basis, in whole or in part, and whether on a free basis or subject to payment, any sound recording, video footage, motion picture, film and/or other audio-visual content captured by any means whatsoever inside the Tournament site (including, without limitation, the competition courts, the practice courts and inside any restricted areas including locker rooms and areas reserved for players) regard-

X. EXHIBITS

less of the means of transmission or media whether now known or in the future (all of such rights, being Broadcast Rights), other than to the extent expressly permitted under this Policy;

- 3.1.14. subject to paragraphs 3.1.15 and 3.1.16 below, the Accreditee is in particular prohibited from:
- 3.1.14.1. filming Tournament matches, regardless of the category (e.g. singles, doubles, junior, wheelchair tournament, legends trophy) or courts (including competition courts and practice courts);
- 3.1.14.2. undertaking or facilitating live or delayed broadcast coverage (including, by way of example only, live broadcasting/streaming through platforms such as Periscope or Meerkat) from any location within the Tournament site whatsoever;
- 3.1.14.3. filming or producing studio or stand up footage within the Tournament site, whether by way of live or delayed broadcast;
- 3.1.14.4. soliciting and/or filming personal interviews of players;
- 3.1.14.5. selling footage filmed within the Tournament site;
- 3.1.14.6. producing a magazine or specific program relating to the Tournament and containing footage filmed at the Tournament;
- 3.1.14.7. associating himself/herself with any footage filmed within the Tournament site or with the trademarks, logos or distinctive signs of the Tournament and/or the Accreditor;
- 3.1.14.8. publishing any photographs or footage captured anywhere on the Tournament site during the Tournament for any purpose, except that this shall not prevent the Accreditee from publishing still photographs or video that is less than :60 seconds from the Tournament on his/her personal social media account(s) for solely non-commercial purposes; and/or
- 3.1.14.9. associating, directly or indirectly, all or part of photographs, footage or other audio-visual content captured within the Tournament site with any brand and/or name, whether commercial or not, especially as a part of a sponsorship;

Official Broadcast Partners

- 3.1.15. if the Accreditee is working on behalf of a radio, TV or other media channel, network or platform which has acquired or is otherwise in bona fide possession of legally enforceable Broadcasting Rights to the Tournament (an Official Broadcast Partner), such Accreditee (an Official Broadcast Accreditee) shall be entitled to exercise the Broadcast Rights only to the extent permitted by, and strictly in accordance with, the terms of: (i) the relevant agreement between the owner/licensor of the relevant Broadcast Rights and the Official Broadcast Partner on whose behalf the Accreditee is working; and (ii) any other applicable documentation issued to the Accreditee by the Accreditor from time to time in relation to the exercise of those Broadcast Rights. In the event of any conflict or inconsistency between a term in the documentation referred to in (i) and a term of this Policy or the documentation referred to in (ii), the term in the documentation referred to in (i) shall prevail. Further, any such Accreditee agrees (x) not to onward supply, sublicense or otherwise make any scores or related statistical data from the Tournament available to any third party for use not related to the broadcast, and (y) to restrict their use of such scores and data to use on a contemporaneous basis within the live broadcast of any match, any other uses shall be subject to a delay of at least :30 seconds;

X. EXHIBITS

News Agencies

- 3.1.16. if the Accreditee is not an Official Broadcast Accreditee but has been granted Accreditation by the Accreditor to in order to provide news, information, data and/or reporting in relation to the Tournament, (any such Accreditee, an Official News Access Accreditee), he/she shall be entitled to exercise the Broadcast Rights only to the extent permitted by, and strictly in accordance with, the terms of: (i) the relevant mandatory news access regulations (or similar), if any, prescribed under applicable law in the territory in which the Tournament takes place; and (ii) any other applicable documentation issued to the Accreditee by the Accreditor from time to time in relation to any such news access or reporting. In the event of any conflict or inconsistency between a term in the regulations referred to in (i) and a term of this Policy or the documentation referred to in (ii), the term in the regulations referred to in (i) shall prevail. Further, such Accreditee agrees that he/she will not disseminate, transmit, publish or release from the grounds of the Tournament any live match score or related live statistical data until :30 seconds after the actual occurrence of the incident of match play or action that leads to such live score update (e.g., a point be scored), and that such use shall be solely for news reporting and editorial use;

Assignment of copyright

- 3.1.17. if and to the extent that the Accreditee obtains, acquires or exercises any Broadcast Rights other than as expressly permitted pursuant to paragraphs 3.1.15 or 3.1.16 above, the Accreditee hereby assigns all such Broadcasting rights (including all intellectual property rights therein), by way of a present assignment of past, present and future rights, to the Accreditor (or its nominee). The Accreditee shall do and execute all such further acts and things as are reasonably required to give full effect to the assignment referred to in this paragraph 3.1.17. All goodwill arising from the Accreditee's use or exploitation of any such Broadcast Rights shall accrue to the Accreditor (or its nominee);

Tournament Website

- 3.1.18. no text, photo and/or audio or video content whatsoever from the Tournament official website ([\[insert website\]](#)) or from the Accreditor's or the ATP's official websites shall be reproduced and/or represented, in any manner whatsoever, on any other media without the prior written consent of the Accreditor and/or the ATP;

Data

- 3.1.19. unless approved in advance in writing by the Accreditor or ATP, the Accreditee may not continually collect, disseminate, transmit, publish or release from the rounds of the Tournament any match scores or related statistical data (the Statistical Data), during match play (from the commencement of a match through its conclusion) for any commercial, betting or gambling purpose. In particular he/she shall not use any communication device (including without limitation a mobile telephone, tablet or laptop) to transmit Statistical Data to a third party in connection with the placing of a bet or for any improper, corrupt, fraudulent or otherwise unlawful purpose whatsoever. As between the parties, the Accreditor remains the sole and exclusive owner of the Statistical Data;

Gambling

- 3.1.20. he/she shall not engage, whether directly or through an intermediary and regardless of the method (including, without limitation, by way of using online

X. EXHIBITS

communication techniques) in any form of gambling or betting activity whatsoever including private gambling or between physical persons in connection with the Tournament. Further, the Accreditee shall not communicate to any third party any privileged information within the scope of his or her function and unknown to the public in connection with the Tournament, nor shall the Accreditee communicate to any third party any privileged information acquired within the scope of his or her Accreditation and unknown to the public in connection with the Tournament; and

- 3.1.21. without prejudice to paragraph 3.1.20 above, he/she shall comply with the terms of the Tennis Anti-Corruption Program (available for download at <https://www.itia.tennis/tacp/rules>).

4. DATA PROTECTION

- 4.1. The Accreditor may use the Accreditee's personal details (including his/her photograph) for the purposes of: assessing a request for Accreditation, administration, marketing and/or vetting/security checking. The Accreditor may also disclose the Accreditee's personal details to its service providers and agents for these purposes and to the ATP/other tournament owners where the Accreditor reasonably believes that the Accreditee poses a risk in relation to the security, staging or commercial rights of other tournaments.
- 4.2. The Accreditor shall comply with applicable laws when processing the Accreditee's personal details as described in paragraph 4.1 above.

5. INDEMNITY AND LIMITATION OF LIABILITY

- 5.1. The Accreditee hereby indemnifies and holds harmless the Accreditor and ATP against any direct loss or damage to the Accreditor or ATP or their employees, officers or agents or arising out of any dispute, proceedings, claim suit or other action brought against the Accreditor or ATP or their employees, officers or agents by any third party resulting from or in any way connected with (i) negligence or misconduct of the Accreditee at the Tournament site; or (ii) a breach of this Policy by the Accreditee.
- 5.2. PROVIDED THAT NOTHING IN THIS POLICY SHALL EXCLUDE OR LIMIT EITHER PARTY'S LIABILITY FOR DEATH OR PERSONAL INJURY CAUSED BY THE NEGLIGENCE OF THAT PARTY OR THEIR AGENTS OR EMPLOYEES, OR IN RESPECT OF ANY OTHER LIABILITY THAT CANNOT BE LIMITED OR EXCLUDED BY APPLICABLE LAW, NEITHER THE ACCREDITOR NOR ATP SHALL HAVE ANY LIABILITY TO THE ACCREDITEE EITHER IN CONTRACT, TORT (INCLUDING NEGLIGENCE OR BREACH OF DUTY) OR OTHERWISE FOR ANY LOSS, DAMAGE OR EXPENSE SUFFERED BY THE ACCREDITEE, HOWSOEVER CAUSED.

6. MISCELLANEOUS

- 6.1. The Accreditor nominates [\[insert job title\]](#) as the representative (the Tournament Representative) to whom the Accreditee should direct any queries or complaints in connection with his/her Accreditation or the terms of this Policy.
- 6.2. The Accreditor may alter this Policy at any time in its sole discretion if it reasonably believes that such changes are necessary to protect the legitimate interests of the Accreditor and/or the Tournament, and the Accreditee must comply with the Policy as amended.
- 6.3. If any paragraph in this Policy is rendered void or unenforceable by any court or authority of competent jurisdiction then all other provisions of this Policy will

X. EXHIBITS

remain in full force and effect and will not in any way be impaired provided the parties agree a replacement provision which is as close as is legally permissible to the provision found invalid or unenforceable.

- 6.4. The Accreditation and this Policy shall be governed by the laws of [insert jurisdiction] and the Accreditor and Accreditee agree that the courts of [insert jurisdiction] shall have exclusive jurisdiction over any dispute (whether contractual or non-contractual) in relation to this Accreditation Policy.

X. EXHIBITS

EXHIBIT AD - ATP Fantasy Sport and Betting Sponsorship

A. Compliance with the TACP

The TACP currently provides that no Covered Person shall, directly or indirectly, facilitate any other person to wager on the outcome or any other aspect of any professional tennis event or any other tennis competition. The ITIA has determined that the provision of the following benefits by a tournament to a Tennis Betting Operator would be deemed to be “facilitation” and are therefore prohibited and subject to penalty under the TACP:

- 1) Direct linking from a tournament digital or social media platform to a Tennis Betting Operator website where tennis wagers can be placed (i.e., one (1) click 1) (for the avoidance of doubt indirect linking (i.e., two (2) clicks) from a tournament digital or social media platform to a Tennis Betting Operator website where tennis wagers can be placed is allowed).
- 2) Displaying live odds for matches on a tournament digital or social media platform (including in a match stream shown on such platform);
- 3) Offering and accepting tennis wagers on behalf of a Tennis Betting Operator on any tournament digital or social media platform or otherwise;
- 4) Allowing a Tennis Betting Operator, directly or through a third party, to offer and accept in-person tennis wagers at a tournament site or at any official tournament-related event (e.g., at a booth or party);
- 5) In-stadia or on-site tournament or Tennis Betting Operator advertising that encourages spectators to place an in-venue tennis wager (e.g., go to website and place a bet now);
- 6) Any of the following activities by tournament owner, operator, director, or employee in their individual capacity:
 - Serving as a spokesperson / ambassador for a Tennis Betting Operator;
 - Writing for a Tennis Betting Operator website or publication (excludes general tournament press releases and tournament promotions or announcements);
 - Making personal appearances on behalf of a Tennis Betting Operator;
 - Promoting a Tennis Betting Operator to the general public through posts or links to the Tennis Betting Operator on the individual's personal social media accounts or websites;
 - Appearing in commercial advertisements that encourage others to bet on tennis;
 - Wearing or otherwise publicly displaying Tennis Betting Operator logos or brand images on apparel, personal equipment or stationery; and
 - Accepting hospitality or gifts, free or subsidized travel, or any other personal benefit from a Tennis Betting Operator.

In addition, the provision of the following benefits to a Tennis Betting Operator would be deemed to be “facilitation” by an active player (i.e., any player who has not officially retired), player support team member, and/or official and therefore tournaments are prohibited from providing such sponsorship benefits in order to safeguard players,

X. EXHIBITS

player support team members and officials from inadvertent violations of the TACP:

- 1) No player/player support team/official activation of any nature, this includes:
 - appearances at a Tennis Betting Operator information booth or box;
 - wearing or otherwise publicly displaying Tennis Betting Operator logos or brand images on or off court;
 - attending or participating in events sponsored by or involving only the Tennis Betting Operator;
 - use by a Tennis Betting Operator of player/player support team names or images (including match and non-match footage); and
 - social media posts mentioning a Tennis Betting Operator or linking to a Betting Operator website or platform by the player/player support team member/official;
- 2) No use of player/player support team member images in tournament advertisements/collateral/social media content that includes only the branding of the Tennis Betting Operator;
- 3) No provision of gear or merchandise with Tennis Betting Operator logos or branding to players/player support team members/officials for use on or off the court (e.g., towels, water bottles, tape);
- 4) No provision of hospitality or gifts, free or subsidized travel, or any other personal benefit to a player/player support team member/official from a Tennis Betting Operator.

B. Protecting the Integrity of the Sport

Any tournament that takes a sponsorship from a Tennis Betting Operator shall comply with the following:

- 1) No Tennis Betting Operator as title and/or presenting sponsor of a tournament; No naming rights to player areas;
- 2) Only betting exchanges that also offer sportsbook betting are permitted as a Tennis Betting Operator;
- 3) Tennis Betting Operator and tournament advertising in and on broadcast (and shoulder programming) must comply with broadcast and local restrictions (i.e., in the event a territory does not allow the broadcast to be shown due to a ban on sports betting advertising, the tournament shall have the right to opt out of such sponsorship agreement); Tennis Betting Operators may only use the ATP category stamp in advertisements when using the ATP-Tournament lockup logo, provided that the lockup logo may not be used with the image of an identifiable tennis player (regardless of whether the individual in the image competes on the ATP Tour).
- 4) No display of live odds for matches in the tournament venue or at other official tournament sites;
- 5) Tennis Betting Operator on-court signage (Refer to Chart at end of this Exhibit AD):
 - No signage or banners on or in the immediate physical vicinity of the chair umpire or line umpire chair;

X. EXHIBITS

- No signage or banners on or in the immediate physical vicinity of the player benches; No signage or banners on player entrance arch; and and
 - No ads on videoboards when players are on court warming up or when playing (excluding changeovers and setbreaks); The Tennis Betting Operator logo may be placed on the shot clock and serve speed box;
 - Tennis Betting Operator logo cannot be the only logo/mark on backwall signage; and
 - No more than 40% of total on-court fixed signage (excluding LED) or 40% of total display time
- 6) No Tennis Betting Operator logo or brand images on chair umpire or line umpire clothing;
 - 7) Tennis Betting Operator logo on media backdrops must be the same size as and appear no more frequently than other logos on the backdrop, and must be dispersed throughout the backdrop.
 - 8) Credentials for Tennis Betting Operator representatives limited to non-player restricted areas (i.e., no access to player lounge or locker room; access to player restaurant and press conferences permitted if accompanied by tournament staff);
 - 9) Official player hotels shall not offer in-person tennis wagering;
 - 10) No provision of Tennis Betting Operator informational or promotional materials to players/player support team members/officials/tournament staff;
 - 11) No targeting minors;
 - 12) Tennis Betting Operator may have informational booth in vendor area, which may include information on downloading the sponsor's app but should not directly encourage to place bets or promote a Tennis Betting Operator website URL;
 - 13) No tournament shall receive compensation linked to the sponsorship from the Tennis Betting Operator based upon revenue or betting volume of their event;
 - 14) 10% of the sponsor fee (based on gross revenue) shall be paid to ATP as a contribution toward the expense of anti-corruption; For combined events 5% shall be paid to each Tour toward the expense of anti-corruption;
 - 15) Tournaments may not apply for sport gaming license or become a betting operator with any relationship to wagering on tennis; and
 - 16) Tournament owner(s), Tournament Director, Tournament Physicians and other staff who would regularly have direct contact with the players and/or are privy to non-public information about players must complete the Tennis Integrity Protection Programme (TIPP). Such staff likely includes, but is not limited to, the Credentials Coordinator, Accommodation Coordinator, IT Coordinator, Head of Security, Media Director, Player Desk Staff and Massage Therapists.

C. Repute and Integrity of Tennis Betting Operators

The following requirements are to provide transparency, assure compliance with Sections A and B, and assure the quality of the Tennis Betting Operator:

- 1) Approval process:
 - Tournaments must apply to and secure approval from ATP at least thirty (30) days prior to entering into an agreement with a Tennis Betting Operator;
 - Application must sufficiently detail all benefits, activations, links to tennis wa-

X. EXHIBITS

- gering, and compensation structure; and
 - o Tournament must assist ATP's due diligence process;
- 2) Tennis Betting Operator must be registered/licensed by appropriate legal authority in the territories it offers betting;
 - 3) Tennis Betting Operator must employ industry standard measures (e.g. geo-gating and age-restrictions) to prevent unauthorized users from engaging in unlawful sports wagering for the term of the sponsorship.
 - 4) Tennis Betting Operator shall not be:
 - o entities engaged in the collection, publication or other exploitation of material that would reasonably be expected to have a material adverse effect on tennis integrity (as determined by ATP);
 - o currently the subject of an investigation or proceeding for betting-related corruption or betting-related criminal offense or any other materially significant betting integrity-related investigation brought by the ITIA or any relevant betting-integrity, governmental, regulatory or gaming authority;
 - o currently an adverse party in litigation or arbitration involving ATP or any of its events in respect of unofficial data or betting;
 - o currently the subject of legal proceedings brought by any tennis governing body in respect of any unauthorized in-stadium collection or exploitation of unofficial data;
 - o entities that have been convicted of betting-related corruption, betting-related criminal offense by the ITIA or any relevant betting-integrity, governmental, regulatory or gaming authority within the prior 3 years;
 - o entities that have a current sanction from any relevant betting-integrity related, governmental, regulatory or gaming authority as to a material violation or series of violations that could reasonably be expected to call the applicable entity's betting-related integrity into question;
 - 5) Tennis Betting Operator must purchase ATP official scores. For Masters 1000 and ATP 500 tournaments, the betting sponsor must purchase the fastest official scoring feed (in effect from January 1, 2024).
 - 6) Betting Sponsor must agree to cooperate and coordinate with ATP, ATP's official data partner, and the ITIA with respect to any suspicious betting patterns or other integrity related issues, and must make available to the ITIA any betting-related information that the ITIA reasonably requests and have an MOU with the ITIA (if requested);
 - 7) Tennis Betting Operator must agree to comply with the provisions set forth in Section A and Section B above;
 - 8) Agreement must include a termination right if (a) the Tennis Betting Operator's license in domestic market of tournament is lost or suspended, (b) the Tennis Betting Operator is no longer in compliance with applicable laws and regulations (including advertising), (c) the Tennis Betting Operator violates the provisions set forth in Section A or, Section B above; (d) the Tennis Betting Operator combines unofficial data with the official data of relevant stakeholder, (e) the Tennis Betting Operator fails to reasonably cooperate with any integrity-related ITIA requests or ITIA investigations, and (f) ATP rules change prohibiting sponsorships in this category; and

X. EXHIBITS

- 9) Renewal / extension / amendment / early termination of agreement requires notification to, and approval by, ATP.

INDEX

Beverages 108

Officials 108

Players 108

Bonus Pool 9, 11

Broadcast Quality Standards 274

Byes - Assignment and Placement 157

C

Calling of Matches 170

Cases & Decisions

Alternate Sign-In Procedures 162

Balls

Ball Change Error 106

Broken Ball 106

New Balls to Wrong Player(s) 106

Re-Warm-Up, Balls 106

Soft Ball 106

Clay Court Cases 180

Can't Find Ball Mark 180

Doubles Ball Mark Appeal 180

Must Both Players on a Team Stop 180

Overrule Then Inspect Ball Mark 180

Correcting an Error in Seeding 142

Correct When Left Out of Draw 141

Default - List Penalties 228

Don't Have Eight Seeds 142

Eligible for Lucky Loser 163

Extending Closing Times 163

Hindrance Cases 177

Corrected Call 177

Early Foot Fault Call 178

Inadvertent Hindrance 178

Opponent Makes Noise 178

Opponent's Gear Falls On The Court 177

Singles Stick Falls 178

Spectator Noise 178

Late Transportation 228

Main Draw Seed for a Qualifier 142

Main Draw Vacancy Before Qualifying Starts 166

May I Accept a Challenger Wild Card after losing in an ATP Qualifying 150

May I Accept a Wild Card after Withdrawing from an ATP Tour 500 Qualifying 150

May I Play Grand Slam Qualifying After Losing in an ATP Tour tournament? 150

INDEX

Medical Cases 191

Chair Umpire Orders Medical Time-Out 193

Delayed Medical Time-Out 191

Equipment Out of Adjustment (Knee Brace) 191

Exceeding 90 Seconds: Code Violation 191

Medical Time-Out and Re-Warm-Up 191

Medical Time-Out Request Honored? 191

Medical Time-Out Starts When? 192

Only 90 Seconds to Re-Tape 192

Penalties After Medical Time-Out 192

Re-Injury 192

Resuming Play After a Medical Time-Out 192

Singles Retirement: Still in Doubles? 194

Tape Is Not "Equipment Adjustment" 193

Treatment for Fatigue 193

Treatment: Within 90 Seconds 193

When to Take a Medical Time-Out? 193

Miscellaneous Officiating Cases 194

Ball Hits Net Post Signage 194

Ball Rolls Onto Court 195

Ball Touches Net Pipe Support 195

Broken String: First Service Fault 194

Broken String: First Service Let 194

Broken String: No Racquets 194

Intimidating Line Umpire 196

Invasion: Ball in Play 195

Invasion: No Replay 195

Player Hits Net Pipe Support 195

Player Touches Net Outside of Singles Stick 195

Receiver Not Ready 194

Service Order 196

Touching Net or Opponent's Court 195

Moving Indoors at an Outdoor event 174

No Medical? Big Mistake 212

No Penalty After Retirement 216

Partner Injured: Who May Replace Him? 165

Player Entitled to Minimum Rest 173

Player Pulled from ATP 500 Qualifying 142

Players Don't Call Lines 197

Potential Special Exempt Loses: After 9 p.m. 145

Potential Special Exempt Playing at 9 p.m. Friday 144

Protected Ranking is for Entry, Not Seeding 155

Punctuality 228

Rain Delayed Semifinal, When to Play Final? 174

Rain: How Many Matches Per Player? 174

INDEX

Remake of Draw 158
Scheduling Priorities 174
Seeds Withdraw or Are Withdrawn 167
Special Exempt Awarded if Player Is in Semis? 145
Tennis Law - Cases 175
 Appealing for a Let 176
 Appeal of Judgment Calls 175
 Appeal of the "Facts": Receiver 176
 Appeal of the "Facts": Server 176
 Umpire Blocked on Question of Fact 176
Time and Equipment Cases 184
 Ball Person as Personal Valet 185
 Changing Shoes 185
 Contact Lens 186
 Crowd Movement 184
 No Play After 90 Seconds 186
 Re-Gripping Racque 186
 Replacing Shoes 186
 Shoe Breaks 186
 Time: Refusal to Play 186
 Time Violation + 25 Seconds = Code 185
 Time Violation, No Play, Results in Code 185
 Two Explanations are Enough 185
Toilet Visit 187
Toilet Visit: When Does Play Resume? 187
Two Chances 149
Unused Wild Cards 149
Use of Both Rankings 153
What Size Draw 141
Which Lucky Loser to Insert? 163
Who Goes In 163
Who to Seed in singles Qualifying 142
Wild Card After ATP Tour 500 Qualifying Withdrawal 149
Wild Card Pulled from Qualifying 149
Categories of Tournaments 7
Ceiling Height 102
Ceremonies 226
Chairs 107
 Chair Umpire 107
 Line Umpire 107
 Net Judge 108
 Player 108

INDEX

Chair Umpire 91
 Assignment and Designation Process 91
 ATP Challenger Tour Tournaments
 Chair Umpires 92
 Supplemental Chair Umpires 92
 ATP Tour Tournaments 91
 Fees and Expenses 92
 General 92
 Responsibilities 92
Challenges, number of 181, 307
Change of Tournament Site 9
Chief of Umpires 322
 Assignment and Designation Process 98
 Fees and Expenses 98
 General 98
 Responsibilities 98
Clear Mistake 178
Clothing Designs 217
Coaches 226
Coaching 226
Code of Conduct 208
Code Violations Not Witnessed By Chair Umpire 222
Combined Event 111, 117
Commercial Identification 218
Commitment 10
Commitment and Membership Obligations 11
Communication Devices 109
Composition of Commitment 35
Consent Form 327
Copy machine 109
Corrected Call 177
Correction/Verification of Call 179
Courts 101
 Back Fences, Back Walls, Banners, Signs and Seats 102
 Ceiling Height 102
 Light poles 102
 Preparation of Surface 101
 Size, Position and Color of Courts 101
 Surface 101

INDEX

Credentialing 110
Credentials 112
Crowd Movement 106
Currency 35

D

Default 227
 Penalties 227
Default of Prize Money Payments 35
Delay of Game 182
Doctor 88
 ATP Challenger Tour Tournaments 88, 89
 ATP Tour Tournaments 88
Doubles Draws 141
Draw 136
 Composition of Draws 137
 Minimum Draw Size 136
 Remake of Doubles 158
 Remake of Singles 158
 Size and Method 140
 Time of Draw 147
 Main Draw Doubles 147
 Main Draw Singles 147
 Qualifying Doubles 147
 Qualifying Singles 147
Dress and Equipment 217
Drink Containers 218

E

Electrolyte 108
 Drink Container 218
 Officials 108
 Players 108
 Referee Responsibilities 97
Electronic Review 103, 180, 307
Emergency Situations 125
Entry Fees 121
Entry Obligations 208
Entry Protection 241
Entry Selection 149

INDEX

Direct Acceptances 149
Doubles 152
Qualifiers 149
Special Exempts 150
Wild Cards 150
Entry/Withdrawal Method 128
Entry/Withdrawal Offenses 208
Equipment Abuse 223
Equipment & Supplies 107
 Placement/Approval 107
Exchange Rate Adjustment Rule 44
Exhibition Release 134
Exhibitions 16
 Promotional Fees 17
 Restrictions 16

F

Failure to Complete Match 226
Fee Obligation 35
 ATP Challenger Tour Tournaments 35
 ATP Tour 35
 Late Payments 35
Fees/Other Payments 36
Final Dispute Resolution 237
Fines and Penalties 209
First Aid 118
Food 116

G

Glossary 318
Good Standing 11
Guest Passes/Credentials/Tickets 112
Gym 361

H

Hat 218
Headband 218
Hindrance 177
Hospitality 18
Host Broadcaster 274

INDEX

Host Locality 28, 30, 33
Hotel Accommodations (Rooms) 18
 Other Reservations. 21

I

Ice bath 114
Identification/Visible 217
Inadvertent Hindrance 178
Indoor Facilities 109
Insurance 36
Internet 109

J

Jacket 219

L

Laptop Restrictions 107, 112
Late Payment 45
Leaving the Court 225
Letter of Credit 37
 New/Conditional Tournaments 37
Lighting 101
Limits to On-Site Access 113
Line Umpire 95
 Assignment and Designation Process
 ATP Challenger Tour Tournaments 95
 ATP Tour Tournaments 95
 Clothing 95
 General 95
 Responsibilities 95
Line Umpire Requirement 196
 Five (5) Line Umpires 197
 Four (4) Line Umpires 197
 Full Complement 196
 Hand Signals 197
 Less than a Full Complement 197
 Less Than Four (4) Line Umpires 197
 Number for Matches 196
 Seven (7) Line Umpires 197
 Six (6) Line Umpires 197

INDEX

 Umpiring Without Line Umpires 197
Live Scoring 109
Locker Room 114
Logo Usage 218
Lucky Losers 159
 Selection 159
 Substitution 159

M

Main Draw 7
Mandatory Player Meeting 13
Massage Therapist 88
 ATP Challenger Tour Tournaments 88
 ATP Tour Tournaments 88
Measuring Devices 108
Media Highlight Rights 17
Medical 187
 Bleeding 189
 Cases & Decisions 191
 Evaluation 187
 Penalty 189
 Physical Incapacity 190
 Time-Out 188
 Vomiting 190
Monday Finals 7

N

Net 28, 108
 Net Judge 108
 Net Posts 108
 Net Posts and Net Post Signage 108
New/Conditional Tournaments 37
Nitto ATP Finals - Doubles 62
 Competition Format 62
 Entries 62
 Alternates (s) 63
 Direct Acceptances 62
 Selection Lost 62
 Withdrawal 62
 Order of Play 63

INDEX

- Round Robin 63
- Prize Money and Points 65
- Singles Elimination Competition 65
- Nitto ATP Finals - Singles 59
 - Competition Format 59
 - Entries 59
 - Alternate(s) 59
 - Direct Acceptances 59
 - Selection List 59
 - Withdrawal 59
 - Order of Play 60
 - Round Robin 60
 - Prize Money and Points 62
 - Single Elimination Competition 62
- No Show 319

O

- Offenses 223
- Offices 109
- On-Court Procedures 175
- On-Court Requirements 175
- On-Court Timing Devices 102
- One Tournament Per Week 134
- On-Site Access 113
- On-Site Offenses 217
- On-Site Prize Money Adjustment 44
- On-Site Prize Money Minimums 43
- On-Site Procedures 217
- Order of Play 170
 - Change 170
 - Notes / Reminders 170
 - Notification 170
 - Release Deadline 170
- Other Circuit 203
- Overrule 178

P

INDEX

- Payment of Fines 212, 231
 - ATP Tour 232
 - Procedures for Appeal 232
- Phones 109
- Physical Abuse 223
- Physical Exam 14
- Physiotherapist 88
 - ATP Challenger Tour Tournaments 88, 89
 - ATP Tour Tournaments 88
- Player Compensation & ATP Variable Bonus Pool Rule 50
- Player Eligibility 14
- Player Entry and Commitment To Rules 9
- Player Introductions 201
- Player Lounge 113
- Player Major Offenses 233
- Player Obligations 21, 23
- Player Passes/Credentials 112
- Player Publicity and Promotion 14
- Player Rights 175
- Player Treatment Room 117
- Player University 14
- Playing Another event 212
- Play-Up Regulation
 - Restrictions 135
- Point Penalty Schedule 222
- Post-Match Media Availability 230
- Practice Courts 103
- Premier Player Protocol 360
- Privacy Notice ("HIPPA") 330
- Prize Money 37
 - Charts 317
 - General 38
- Prize Money / Fee Payments
 - ATP Challenger Tour Tournaments 44
 - ATP Tour Tournaments 44
- Prize Money Formula Rule 56
- Prizes and Non-Cash Awards 45
- PR & Marketing 87
- Prohibited Promotional Fees 234
- Promotional Activities 213, 214

INDEX

Punctuality 228

Q

Qualifier Reservations 21

Qualifying 7

Seed Placement 157

Singles

Entry Deadline 122

General 8

Location 8

Surface 8

Time 122

Quality/Broadcast 18

Questions of Fact 175

Questions of Tennis Law 175

R

Racquet 219

Racquet Abuse 223

Rain 171

Rankings

Definitions 239

Eligibility 239

Referee 96

Assignment and Designation Process 96

ATP Challenger Tour Tournaments 97

ATP Tour Tournaments 96

Fees and Expenses 97

General 97

Responsibilities 97

Waiver of Obligation 97

Release from Financial Commitment 46

Repeal of Withdrawal Fines/Penalties 213

Rest Periods - Minimums and Guidelines 171

Between Main Draw and Prior Week's Tournament(s) 171

Between Main Draw and Qualifying 172

Between Main Draw Matches 172

Between Semi-final and Final 173

Restrictions 220

General 220

INDEX

Government 220

Other Tennis event 220

Timing 220

Tobacco 220

Retirement or Withdrawal Penalty (On-Site) 211

Retiring from the Professional Tennis Circuit 247

Review Official 91

Review of Penalties 216

Re-warm up 183

S

Sawdust 104

Scheduling Committee 168

Scheduling of Matches 168

Daily Overview 169

Main Draw 168

Considerations and Priorities 168

Qualifying 169

Tournament Week Plan 168

Wednesday starts 171

Scoreboards 108

Scoring of Match 198

Seating and Attendance 18

Seats 102

Security at Tournaments 107

Seeds 154

Definition 155

Doubles 154

Number 155

Placement 156

Qualifying 157

Replacement 151, 166

Selection of Entries 149

Shirt 219

Shoes 220

Clay Courts 221

General 220

Grass Courts 221

Shorts 220

INDEX

Shot clock 103
Signs 102
Singles Draws 140
Singles Finals Options 8
Sleeveless 219
Sleeves 219
Socks 220
Special Events - Exhibitions 16
Special Exempt Non Appearance 144
Special Exempts 142, 320
 Eligibility 142
 Non-Appearance 320
 Number 143
 Process 144
 Selection 143
Spectator seating 102
STARS Program 15
 Penalties 230
Start of Match 175
Start of Tournament 175
Stoppage and Postponement of a Match 183
Stringing Service 115
submersion bath 114
Substitutions 159
Supervisor
 Assignment & Designation 90
 ATP Challenger Tour Tournaments 88, 89
 ATP Tour Tournaments 88
 Fees and Expenses 90
 General 90
 Responsibilities 90
Suspensions and Collection of Fines 236
 Stay of Suspensions Pending Appeal 236
 Suspension for Non-Payment of Fines 236
 Suspension - Weeks/Scope 236
Sweater 219

T

Tape Delay/Repeats 274

INDEX

Taxes 45
 Notice of Withholdings 45
 Withholding From Prize Money 45
Temperature 109
Tennis Equipment Manufacturer 218
Ticketing 110
Tier I and Tier II Agents 89
 Tier I 90
 Tier II 90
Time Violations 229
Toilet Break 187
Tour Manager 87
 Appointment 87
 Responsibilities 87
Tournament Credentialing 110
Tournament Director 87
 Appointment 87
 Responsibilities 87
Tournament Financial Information 46
Tournament Financial Information Rule for Masters 1000 Tournaments 46
Tournament Obligations 18, 203
 ATP Challenger Tour Tournaments 22
Tournament Violations 203
Tournament Week 7
Towels 108, 218
Transgender Athlete Participation 121
Transportation 117
Treatment Room 117

U

United Cup 7, 65, 66, 68, 69, 74, 77, 102, 121, 216, 217, 240, 242, 244
Unsatisfied Player Commitment Penalties 13
 Failure To Participate in the Nitto ATP Finals 13
 Review of Penalties for Breach of Commitment 13
Unsportsmanlike Conduct 224

V

Vacancies 159

INDEX

- Other Vacancy Procedures 167
- Prior to Qualifying Competition 165
- Qualifying started or finished 166

Ventilation 109

Verbal Abuse 224

Verification of Call 179

Video Review (“VR”) 184

Violations/Fines 221

- Commercial Identification 221
- Other Tennis event 222
- Tennis Equipment Manufacturer’s logo 221
- Unacceptable Attire 222

Virtual Insertion 280

W

Waiver of Claims 14

Warm up 183

Web Filtering 109

- Internet 109
- Media Facilities 119
- Player Lounge 113

Wednesday starts 171

Wild Card Non-Appearance 212

Wild Cards 147

- Limitation 148
- Regulations 147
- Restrictions

- Doubles 148
- Singles 147

Withdrawals 128

- Emergency Situations 125
- Method 128
- No Play After Withdrawal 131
- On-Site 211
- Penalties 131, 211

World Championships 59